

SHARP SERVICE MANUAL

S64T921FL94//

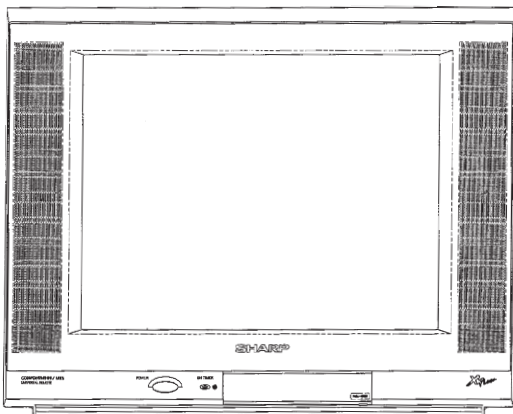

COLOR TELEVISION

Chassis No. GA-4

MODEL **21FL94**

In the interests of user-safety (Required by safety regulations in some countries) the set should be restored to its original condition and only parts identical to those specified should be used.

CONTENTS

	Page
• ELECTRICAL SPECIFICATIONS	1
• IMPORTANT SERVICE SAFETY PRECAUTION	2
• LOCATION OF USER'S CONTROL	4
• INSTALLATION AND SERVICE INSTRUCTIONS	5
• SERVICE MODE	6
• ADJUSTMENT METHOD	12
• WAVEFORMS	25
• CHASSIS LAYOUT	26
• BLOCK DIAGRAM	27
• DESCRIPTION OF SCHEMATIC DIAGRAM	31
• SCHEMATIC DIAGRAMS	32
• PRINTED WIRING BOARD ASSEMBLIES	36
• REPLACEMENT PARTS LIST	40
• PACKING OF THE SET	46

ELECTRICAL SPECIFICATIONS

POWER INPUT	AC 110~220 V, 50/60 Hz
POWER RATING	90W
PICTURE SIZE	1,239 cm ² (192sq inch)
CONVERGENCE	Magnetic
SWEEP DEFLECTION	Magnetic
FOCUS	QFP/UNI-B1 Electrostatic
INTERMEDIATE FREQUENCIES	
Picture IF Carrier Frequency	45.75 MHz
Sound IF Carrier Frequency	41.25 MHz
Color Sub-Carrier Frequency	42.17 MHz
	(Nominal)
AUDIO POWER	
OUTPUT RATING	4.0 W(RMS) x 2pcs

SPEAKER	
SIZE	12 x 5 cm, 2pcs
VOICE COIL IMPEDANCE	16 ohm at 400 Hz
ANTENNA INPUT IMPEDANCE	
VHF/UHF	75 ohm Unbalanced
TUNING RANGES	
VHF-Channels	2 thru 13
UHF-Channels	14 thru 69
CATV Channels	1 thru 125
	(EIA, Channel Plan U.S.A.)

Specifications are subject to change without prior notice.

SHARP CORPORATION

This document has been published to be used for after sales service only.
The contents are subject to change without notice.

IMPORTANT SERVICE SAFETY PRECAUTION

- Service work should be performed only by qualified service technicians who are thoroughly familiar with all safety checks and the servicing guidelines which follow:

WARNING

1. For continued safety, no modification of any circuit should be attempted.
2. Disconnect AC power before servicing.
3. Semiconductor heat sinks are potential shock hazards when the chassis is operating.
4. The chassis in this receiver has two ground systems which are separated by insulating material. The non-isolated (hot) ground system is for the B+ voltage regulator circuit and the horizontal output circuit. The isolated ground system is for the low B+ DC voltages and the secondary circuit of the high voltage transformer.
To prevent electrical shock use an isolation transformer between the line cord and power receptacle, when servicing this chassis.

SERVICING OF HIGH VOLTAGE SYSTEM AND PICTURE TUBE

When servicing the high voltage system, remove the static charge by connecting a 10k ohm resistor in series with an insulated wire (such as a test probe) between the picture tube ground and the anode lead. (AC line cord should be disconnected from AC outlet.)

1. Picture tube in this receiver employs integral implosion protection.
2. Replace with tube of the same type number for continued safety.
3. Do not lift picture tube by the neck.
4. Handle the picture tube only when wearing shatterproof goggles and after discharging the high voltage anode completely.

X-RADIATION AND HIGH VOLTAGE LIMITS

1. Be sure all service personnel are aware of the procedures and instructions covering X-radiation. The only potential source of X-ray in current solid state TV receivers is the picture tube. However, the picture tube does not emit measurable X-Ray radiation, if the high voltage is as specified in the "High Voltage Check" instructions.
It is only when high voltage is excessive that X-radiation is capable of penetrating the shell of the picture tube including the lead in the glass material. The important precaution is to keep the high voltage below the maximum level specified.
2. It is essential that servicemen have available at all times an accurate high voltage meter. The calibration of this meter should be checked periodically.
3. High voltage should always be kept at the rated value –no higher. Operation at higher voltages may cause a failure of the picture tube or high voltage circuitry and;also, under certain conditions, may produce radiation in exceeding of desirable levels.
4. When the high voltage regulator is operating properly there is no possibility of an X-radiation problem. Every time a color chassis is serviced, the brightness should be tested while monitoring the high voltage with a meter to be certain that the high voltage does not exceed the specified value and that it is regulating correctly.
5. Do not use a picture tube other than that specified or make unrecommended circuit modifications to the high voltage circuitry.
6. When trouble shooting and taking test measurements on a receiver with excessive high voltage, avoid being unnecessarily close to the receiver.
Do not operate the receiver longer than is necessary to locate the cause of excessive voltage.

IMPORTANT SERVICE SAFETY PRECAUTION

(Continued)

BEFORE RETURNING THE RECEIVER

(Fire & Shock Hazard)

Before returning the receiver to the user, perform the following safety checks.

1. Inspect all lead dress to make certain that leads are not pinched or that hardware is not lodged between the chassis and other metal parts in the receiver.
2. Inspect all protective devices such as non-metallic control knobs, insulating materials, cabinet backs, adjustment and compartment covers or shields, isolation resistor-capacity networks, mechanical insulators, etc.
3. To be sure that no shock hazard exists, check for leakage current in the following manner.
 - Plug the AC cord directly into a 110~220 volt AC outlet, (Do not use an isolation transformer for this test).
 - Using two clip leads, connect a 1.5k ohm, 10 watt resistor paralleled by a 0.15 μ F capacitor in series with all exposed metal cabinet parts and a known earth ground, such as electrical conduit or electrical ground connected to earth ground.
 - Use an AC voltmeter having with 5000 ohm per volt, or higher, sensitivity to measure the AC voltage drop across the resistor.

- Connect the resistor connection to all exposed metal parts having a return to the chassis (antenna, metal cabinet, screw heads, knobs and control shafts, escutcheon, etc.) and measure the AC voltage drop across the resistor.

All checks must be repeated with the AC line cord plug connection reversed. (If necessary, a non-polarized adapter plug must be used only for the purpose of completing these check.)

Any current measured must not exceed 0.5 milliamp. Any measurements not within the limits outlined above indicate of a potential shock hazard and corrective action must be taken before returning the instrument to the customer.

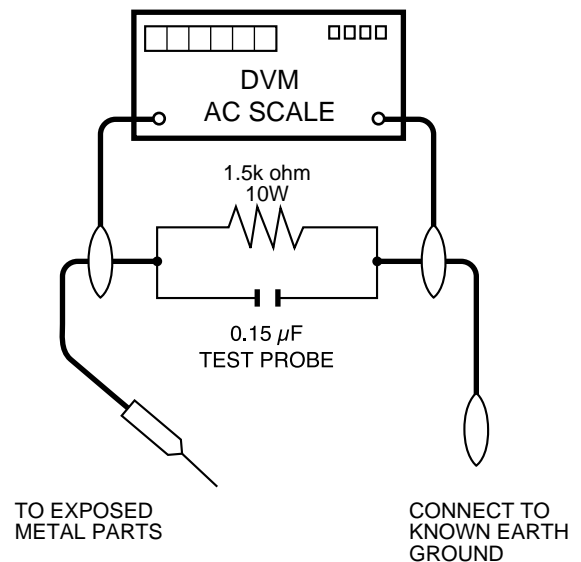

SAFETY NOTICE

Many electrical and mechanical parts in television receivers have special safety-related characteristics. These characteristics are often not evident from visual inspection, nor can protection afforded by them be necessarily increased by using replacement components rated for higher voltage, wattage, etc.

Replacement parts which have these special safety characteristics are identified in this manual; electrical components having such features are identified by " \triangle " and shaded areas in the Replacement Parts Lists and Schematic Diagrams.

For continued protection, replacement parts must be identical to those used in the original circuit. The use of substitute replacement parts which do not have the same safety characteristics as the factory recommended replacement parts shown in this service manual, may create shock, fire, X-radiation or other hazards.

LOCATION OF USER'S CONTROL

Quick Reference Control Operation

Location of Controls

Front Panel

POWER

Press → On.
Press again → Off.

SENSOR AREA FOR REMOTE CONTROL

MENU

Press → Accesses MAIN MENU.
Press again → Exits MAIN MENU.

VOLUME UP/DOWN
(+) Increases sound.
(-) Decreases sound.

CHANNEL UP/DOWN

(▲) Selects next higher channel.
(▼) Selects next lower channel.

VIDEO [IN 2] L-AUDIO-R

(INSIDE DOOR)

Basic Remote Control Functions

POWER

Press → On.
Press again → Off.

REMOTE KEYPAD

Accesses any channel from keypad.

FLASHBACK

Returns to previous channel.

PERSONAL PREFERENCE

With the Personal Preference buttons, you can program your favorite programs by using the 4 categories A, B, C and D. The channels can be accessed quickly by using these buttons.

VOLUME UP/DOWN

(+) Increases sound.
(-) Decreases sound.
• In menu mode, changes or selects the TV adjustments.

MENU

Press → Accesses MAIN MENU.
Press again → Exits MAIN MENU.

MUTE

Press → Mutes sound.
Press again → Restores sound.
• CLOSED CAPTION appears when sound is muted.

POWER (DVD/VCR)

Press → On.
Press again → Off.

DVD/VCR CONTROL

Infrared Transmitter Window

CATV/DVD-TV/VCR MODE buttons

Press TV/VCR, sends power and channel select commands (Channel up/down and Random Access buttons) to the TV and VCR control.
Press CATV/DVD, sends power and channel select commands to a cable TV converter and DVD control.

DISPLAY

Press → Displays receiving channel for four seconds.
Press again → Removes display.
• Temporarily displays receiving channel when in Closed Caption mode.

INPUT

Press → Switch to external video INPUT 1 mode or COMPONENT mode.
Press 2 times → Switch to external video INPUT 2 mode.
Press 3 times → Switch back to the original TV mode.

ENTER

Used in some instances where a Cable Converter Box requires an "enter" command after selecting channels, when using the REMOTE KEYPAD button.

CHANNEL UP/DOWN

(▲) Selects next higher channel.
(▼) Selects next lower channel.
• Moves the "●" mark of the MENU screens.

SKIP/VCR-CH

REC

Note:

- The above shaded buttons on the Remote Control glow in the dark. To use the glow-in-the-dark display on the remote control, place it under a fluorescent light or other lighting.
- The phosphorescent material contains no radioactive or toxic material, so it is safe to use.
- The degree of illumination will vary depending on the strength of lighting used.
- The degree of illumination will decrease with time and depending on the temperature.
- The time needed to charge the phosphorescent display will vary depending on the surrounding lighting.
- Sunlight and fluorescent lighting are the most effective when charging the display.

INSTALLATION AND SERVICE INSTRUCTIONS

- Note:** (1) When performing any adjustments to resistor controls and transformers use non-metallic screwdrivers or TV alignment tools.
 (2) Before performing adjustments, the TV set must be on at least 15 minutes.

CIRCUIT PROTECTION

The receiver is protected by a 3.15A fuse (F701), mounted on PWB-A, wired into one side of the AC line input.

X-RADIATION PROTECTOR CIRCUIT TEST

After service has been performed on the horizontal deflection system, high voltage system, B+ system, test the X-Radiation protection circuit to ascertain proper operation as follows:

1. Apply 110~220V AC using a variac transformer for accurate input voltage.
2. Allow for warm up and adjust all customer controls for normal picture and sound.
3. Receive a good local channel.
4. Connect a digital voltmeter to P603 pin3 and make sure that the voltmeter reads $20 \pm 1.1V$.
5. Apply external 27V DC at P603 pin3 by using an external DC supply, TV must be shut off.
6. To reset the protector, unplug the AC cord and make a short circuit between P603 pin1 and P603 pin2. Now make sure that normal picture appears on the screen.
7. If the operation of the horizontal oscillator does not stop in step 5, the circuit must be repaired before the set is returned to the customer.

HIGH VOLTAGE CHECK

High voltage is not adjustable but must be checked to verify that the receiver is operating within safe and efficient design limitations as specified checks should be as follows:

1. Connect an accurate high voltage meter between ground and anode of picture tube.
2. Operate receiver for at least 15 minutes at 110~220V AC line voltage, with a strong air signal or a properly tuned in test signal.
3. Enter the service mode and set Y-mute ON by using Service R/C.
4. The voltage should be approximately 28.7kV (at zero beam).
 If a correct reading cannot be obtained, check circuitry for malfunctioning components. After the voltage test, make Y-mute off to the normal mode.

SERVICE MODE

Service Mode Overview

1. Service mode is entered by SERVICE key input or CH-UP +VOL-DOWN input during reset.
2. Service mode is cleared by entering SERVICE key command during service mode.
3. If key input port (SERVICE) input is LOW, then it is in service mode.
4. During key input port (SERVICE) input is LOW, clearing service mode by key input SERVICE is disabled.
5. Service mode can be switched to 4 modes as follows by key input MENU;

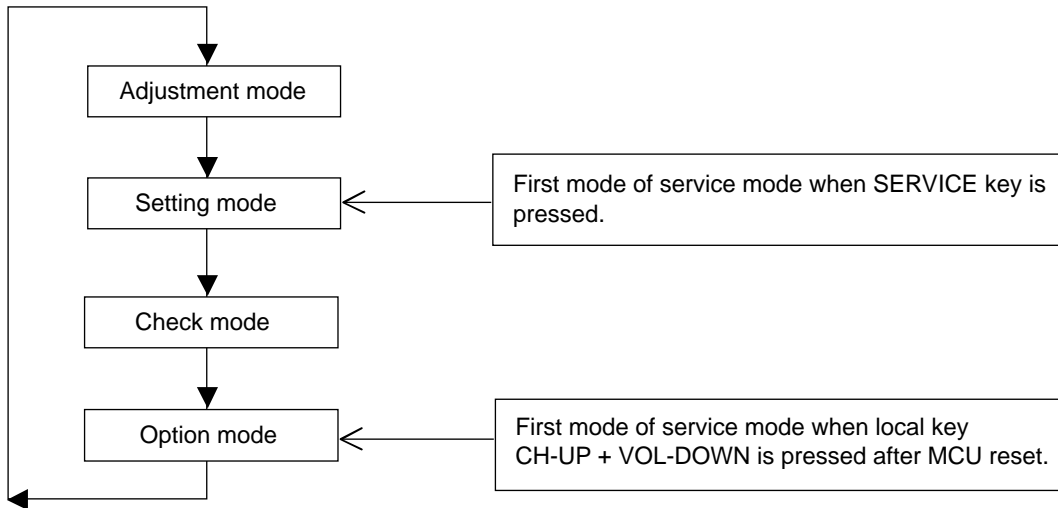

6. AFT processing is disabled during service mode. PLL setting data is set to fo data.
7. All user data are set to default during service mode. FAO and SPEAKER user settings are off and on respectively in service mode. Energy Save is off.
8. Sleep timer, View timer, on timer and off timer are inactivated in Service mode.
9. Sound is muting in service mode except at Adjustment Items V20, M01, M03, M04, M05, and M06.

Adjustment Mode Items

No.	Item Name	IC	Register	Range	Default
V01	SUB-PICTURE	1 Chip	CONTRAST	0~127	127
V02	SUB-TINT	1 Chip	TINT	0~127	64
V03	SUB-COLOR	1 Chip	COLOR	0~127	64
V04	SUB-BRIGHT	1 Chip	BRIGHT	0~255	128
V05	SUB-SHARP	1 Chip	VIDEO-TONE	0~63	32
V06	V-SHIFT	1 Chip	V-SHIFT	0~7	4
V07	H-SHIFT	1 Chip	H-PHASE	0~31	16
V08	RF-AGC	1 Chip	RF-DELAY	0~127	127
V09	V-SIZE	1 Chip	V-SIZE	0~63	32
V10	PIF-VCO	1 Chip	VIF-VCO	0~63	32
V11	R-CUTOFF	1 Chip	R-CUTOFF	0~255	127
V12	G-CUTOFF	1 Chip	G-CUTOFF	0~255	127
V13	B-CUTOFF	1 Chip	B-CUTOFF	0~255	127
V14	R-DRIVE	1 Chip	R-DRIVE	0~127	64
V15	B-DRIVE	1 Chip	B-DRIVE	0~127	64
V16	SUB-COLOR(YUV)	1 Chip	COLOR	0~127	64
V17	SUB-TINT(YUV)	1 Chip	BASEBAND-TINT	0~127	64
V18	CC-POS	MICON	CC-POS	0~255	32
V19	SCREEN CUT OFF	1 Chip	CUT OFF	0~2	0
V20	SUB-VOL	1 Chip	A-ATT	0~127	127
V21	H-VCO	1 Chip	H-VCO	0~7	4
M01	MTS-ATT	MTS	ATT (MTS)	0~15	10
M02	MTS-VCO	MTS	VCO (MTS)	0~63	32
M03	MTS-FILTER	MTS	FILTER (MTS)	0~63	28
M04	MTS-WIDEBAND	MTS	WIDEBAND (MTS)	0~63	27
M05	MTS-SPECTRAL	MTS	SPECTRAL (MTS)	0~63	32
M06	SUB-VOL	MTS	VOL (MTS)	0~63	63

■ SELF ADJUSTMENT

H-VCO

1. When there is H-VCO self-adjustment key input for adjustment item H-VCO, self-adjustment is performed.
2. H-FREE(1chip) is set to 1.
3. H-OUT is set by intelligent monitor output.
4. IM input is set as TIM input.
5. H-VCO(1chip) data is changed so that the number of input pulse is 125 inside 8ms interval.
6. When adjustment completed, OSD display and H-VCO self-adjustment status data of EEPROM are updated.
7. H-FREE(1chip), intelligent monitor output and IM input mode are recovered.

RF-AGC

1. When there is RF-AGC self-adjustment key input for adjustment item RF-AGC, self-adjustment is performed.
2. AGC-OUT is set by intelligent monitor output.
3. IM input is set as AD input.
4. By decreasing RF-AGC (1chip) data from current RF-AGC adjustment value to 0, AFT input voltage becomes the maximum setting value.
5. Increase RF-AGC(1chip) data, when AFT input voltage is at (max. 0.3V) point, adjustment is completed.
6. When adjustment completed, OSD display and RF-AGC self-adjustment status data of EEPROM are updated.
7. Intelligent monitor output and IM input mode are recovered.

PIF-VCO

1. When there is PIF-VCO self-adjustment key input for adjustment item PIF-VCO, self-adjustment is performed.
2. VIF-DEF(1chip) is set to 1.
3. AFC is set by intelligent monitor output.
4. IM input is set as AD input.
5. VIF-VCO(1chip) data is changed so that input voltage becomes 2.5V.
6. When adjustment completed, OSD display and PIF-VCO self-adjustment status data of EEPROM are updated.
7. VIF-DEF(1chip), intelligent monitor output and IM input mode are recovered.

Setting Mode Items

No.	Item Name	IC	Register	Range	Default
F01	VIDEO TONE -GAIN (TV)	1 Chips	V-TONE	0/1	0
F02	VIDEO TONE -GAIN (AV)	1 Chips	V-TONE	0/1	0
F03	VIDEO TONE -GAIN (S-AV)	1 Chips	V-TONE	0/1	0
F04	VIDEO TONE -GAIN(YUV)	1 Chips	V-TONE	0/1	0
F05	ABCL	1 Chips	ABCL	0/1	0
F06	BS	1 Chips	BS-OFF	0/1	0
F07	ABCL-G	1 Chips	ABCL-G	0/1	0
F08	SHP-AV	OFFSET	VIDEO-TONE(OFFSET)	-16~+16	0
F09	SHP-SAV	OFFSET	VIDEO-TONE(OFFSET)	-16~+16	0
F10	SHP-YUV	OFFSET	VIDEO-TONE(OFFSET)	-16~+16	0
F11	RGB-CLIP	1 Chips	EXTRGB-CLIP	0/1	0
F12	E-SAVE	OFFSET	CONTRAST(OFFSET)	0~63	30
F13	FAO-VOL	1 Chips	A-ATT	0~127	120
F14	PIF-G	1 Chips	VIF-GAIN	0~7	4
F15	Y-DELAY(TV)	1 Chips	Y-DELAY	0~7	0
F16	Y-DELAY(AV)	1 Chips	Y-DELAY	0~7	0
F17	Y-DELAY(SAV)	1 Chips	Y-DELAY	0~7	0
F18	Y-DELAY(YUV)	1 Chips	Y-DELAY	0~7	0
F19	TINT-AV	OFFSET	TINT(OFFSET)	-32~+32	0
F20	TINT-SAV	OFFSET	TINT(OFFSET)	-32~+32	0
F21	COL-AV	OFFSET	COLOR(OFFSET)	-32~+32	0
F22	COL-SAV	OFFSET	COLOR(OFFSET)	-32~+32	0
F23	R-DRI(R2)	OFFSET	R-DRI(OFFSET)	-32~+32	0
F24	R-DRI(R)	OFFSET	R-DRI(OFFSET)	-32~+32	0
F25	R-DRI(B)	OFFSET	R-DRI(OFFSET)	-32~+32	0
F26	B-DRI(R2)	OFFSET	B-DRI(OFFSET)	-32~+32	0
F27	B-DRI(R)	OFFSET	B-DRI(OFFSET)	-32~+32	0
F28	B-DRI(B)	OFFSET	B-DRI(OFFSET)	-32~+32	0
F29	V-FREE	1 Chips	V-FREE	0/1	0
F30	GAMMA	1 Chips	GAMMA	0~3	0
F31	TRAP(TV)	1 Chips	TRAP-FINE	0~3	2
F32	TRAP(AV)	1 Chips	TRAP-FINE	0~3	2
F33	H-FREE	1 Chips	H-FREE	0/1	0
F34	1W(TV)	1 Chips	V.WINDOW	0/1	0
F35	1W(AV)	1 Chips	V.WINDOW	0/1	0
F36	YLPF	1 Chips	YSW-LPF	0/1	1
F37	BS-D	1 Chips	BS-DISCHARGE	0~3	0
F38	BS-C	1 Chips	BS-CHARGE	0~3	0
F39	SL(TV)	1 Chips	S-SLICE DOWN	0~3	0
F40	SL(AV)	1 Chips	S-SLICE DOWN	0~3	0
F41	SL(SAV)	1 Chips	S-SLICE DOWN	0~3	0
F42	SL(YUV)	1 Chips	S-SLICE DOWN	0~3	0
F43	AFC2	1 Chips	AFC2-G	0/1	0
F44	VD(TV)	1 Chips	VSYNC-DET	0/1	0
F45	VD(AV)	1 Chips	VSYNC-DET	0/1	0
F46	AS(TV)	1 Chips	AUTO-SLICE	0/1	0
F47	AS(AV)	1 Chips	AUTO-SLICE	0/1	0
F48	AS(SAV)	1 Chips	AUTO-SLICE	0/1	0
F49	AS(YUV)	1 Chips	AUTO-SLICE	0/1	0
F50	FBP(TV)	1 Chips	FBP VTH	0/1	0
F51	FBP(AV)	1 Chips	FBP VTH	0/1	0
F52	FBP(SAV)	1 Chips	FBP VTH	0/1	0
F53	FBP(YUV)	1 Chips	FBP VTH	0/1	0
F54	C.CLIP LEVEL	1 Chips	C.CLIP LEVEL	0/1	0

Setting Mode Items (Continued)

No.	Item Name	IC	Register	Range	Default
F55	PSW	MTS	PSW	0/1	0
F56	FAO-VOL	MTS	VOL	0~63	60
F57	CP	PLL	CHARGE PUMP	0/1	0
F58	CC LEVEL	MICON	CC LEVEL	0/1	0
F59	OSD POS	MICON	OSD POS	0/1	0
F60	OFFSET-ADJ-COL	1 Chips	COLOR	-32~+32	0
F61	OFFSET-ADJ-TINT	1 Chips	TINT	-32~+32	0
F62	OFFSET-ADJ-TINT-YUV	1 Chips	BASEBAND-TINT	-32~+32	0
F63	TIMER4-LOW SPEED	1 Chips	TIMER4 VALUE	0~225	50
F64	TIMER4-HIGH SPEED	1 Chips	TIMER4 VALUE	0~225	125
F65	R-CUT-YUV	1 Chips	R-CUT(OFFSET)	-63~+63	0
F66	G-CUT-YUV	1 Chips	G-CUT(OFFSET)	-63~+63	0
F67	B-CUT-YUV	1 Chips	B-CUT(OFFSET)	-63~+63	0
F68	R-DRI-YUV	1 Chips	R-DRI(OFFSET)	-63~+63	0
F69	B-DRI-YUV	1 Chips	B-DRI(OFFSET)	-63~+63	0
F70	CLOCK-ADJ	1 Chips		0~25	25

Option Mode Items

No	OPTION FUNCTION	0	1	Default Data
001	DEMO	Without DEMO	With DEMO	1
002	DOWNLOAD	Without V-CHIP OP	With V-CHIP OP	0
003	V-CHIP	Without V-CHIP	With V-CHIP	0
004	SPEAKER	Without SPEAKER	With SPEAKER	1
005	FAO	Without FAO	With FAO	1
006	P.PREF	Without P.REF	With P.REF	1
007	UNIV+	Without UNIV+	With UNIV+	1
008	VIEW TIMER	Without VIEW TIMER	With VIEW TIMER	1
009	EZ-SETUP	EZ-SETUP	AUTO PRESET	0
010	PON-CH	Without POWER-ON	With POWER-ON	0
011	FAV-COL	FAV-COL	COL-TEMP	1
012	COMPONENT	Without COMPONENT	With COMPONENT	1
013	AV	Without AV	With AV	1
014	AV2	AV1 system	AV2 system	1
015	MTS	Without MTS	With MTS	1
016	TONE-CTRL	Without S-ADJ	With S-ADJ	1
017	AUTO-OFF	Without AUTO-OFF	With AUTO-OFF	1
018	INIT-LANG	ENGLISH	SPANISH	1
019	SETUP-FLAG	NO SET UP	AUTO SET UP	1
020	AV-FR	"0"=NO AV "1"=REAR "2"=FRONT "3"=REAR & FRONT		3
021	AV3/S-IN	Without AV3/S-IN	With AV3/S-IN	0
022	COMB	Without COMB	With COMB	0
023	AUTO-INPUT	Without AUTO-INPUT	With AUTO-INPUT	1
024	CLOCK	Without CLOCK	With CLOCK	1
025	LED	SEMEX MODEL	SPC MODEL	0
026	FLAT	Not FLAT MODEL	FLAT MODEL	1
027	BASS BOOST	Without BASS BOOST	With BASS BOOST	0
028	DSE	Without DSE	With DSE	0
029	SRS	Without SRS	With SRS	0
030	WHITE-OUT	Without WHITE-OUT	With WHITE-OUT	1

Check Mode

Micron mask version, software version and ROM correction function status are displayed in check mode.

ADJUSTMENT METHOD

Caution: to get into the service mode, one of the ways is press direct key for service items. the other ways is short the main chassis JA301 and JA410

There is three stage of Service Mode data

First stage data from V01 ~ M06

to go into second stage of service mode data, press MENU key

Second stage data from F01 ~ F70

to go into third stage of service mode data, press MENU key

Third stage data from 001 ~ 030

Below is the contents of these data

First Stage

Data	Service Mode	Function	Range	Default Data
V01	SUB-PICTURE	CONTRAST	0~127	127
V02	SUB-TINT	TINT	0~127	64
V03	SUB-COLOR	COLOR	0~127	64
V04	SUB-BRIGHT	BRIGHT	0~255	128
V05	SUB-SHARP	VIDEO-TONE	0~63	32
V06	V-SHIFT	V-SHIFT	0~7	4
V07	H-SHIFT	H-PHASE	0~31	16
V08	RF-AGC	RF-DELAY	0~127	127
V09	V-SIZE	V-SIZE	0~63	32
V10	PIF-VCO	VIF-VCO	0~63	32
V11	R-CUTOFF	R-CUTOFF	0~255	127
V12	G-CUTOFF	G-CUTOFF	0~255	127
V13	B-CUTOFF	B-CUTOFF	0~255	127
V14	R-DRIVE	R-DRIVE	0~127	64
V15	B-DRIVE	B-DRIVE	0~127	64
V16	SUB-COLOR(YUV)	COLOR	0~127	64
V17	SUB-TINT(YUV)	BASEBAND-TINT	0~127	64
V18	CC-POS	CC-POS	0~255	32
V19	SCREEN CUT OFF	CUT OFF	0~2	0
V20	SUB-VOL	A-ATT	0~127	127
V21	H-VCO	H-VCO	0~7	4
M01	MTS-ATT	ATT (MTS)	0~15	10
M02	MTS-VCO	VCO (MTS)	0~63	32
M03	MTS-FILTER	FILTER (MTS)	0~63	28
M04	MTS-WIDEBAND	WIDEBAND (MTS)	0~63	27
M05	MTS-SPECTRAL	SPECTRAL (MTS)	0~63	32
M06	SUB-VOL	VOL (MTS)	0~63	63

Auto Adjustment Item

1. H-VCO
2. RF-AGC
3. PIF-VCO

Second Stage

Data	Service Mode	Function	Range	Default Data
F01	VIDEO TONE -GAIN (TV)	V-TONE	0/1	0
F02	VIDEO TONE -GAIN (AV)	V-TONE	0/1	0
F03	VIDEO TONE -GAIN (S-AV)	V-TONE	0/1	0
F04	VIDEO TONE -GAIN(YUV)	V-TONE	0/1	0
F05	ABCL	ABCL	0/1	0
F06	BS	BS-OFF	0/1	0
F07	ABCL-G	ABCL-G	0/1	0
F08	SHP-AV	VIDEO-TONE(OFFSET)	-16~+16	0
F09	SHP-SAV	VIDEO-TONE(OFFSET)	-16~+16	0
F10	SHP-YUV	VIDEO-TONE(OFFSET)	-16~+16	0
F11	RGB-CLIP	EXTRGB-CLIP	0/1	0
F12	E-SAVE	CONTRAST(OFFSET)	0~63	30
F13	FAO-VOL	A-ATT	0~127	120
F14	PIF-G	VIF-GAIN	0~7	4
F15	Y-DELAY(TV)	Y-DELAY	0~7	0
F16	Y-DELAY(AV)	Y-DELAY	0~7	0
F17	Y-DELAY(SAV)	Y-DELAY	0~7	0
F18	Y-DELAY(YUV)	Y-DELAY	0~7	0
F19	TINT-AV	TINT(OFFSET)	-32~+32	0
F20	TINT-SAV	TINT(OFFSET)	-32~+32	0
F21	COL-AV	COLOR(OFFSET)	-32~+32	0
F22	COL-SAV	COLOR(OFFSET)	-32~+32	0
F23	R-DRI(R2)	R-DRI(OFFSET)	-32~+32	0
F24	R-DRI(R)	R-DRI(OFFSET)	-32~+32	0
F25	R-DRI(B)	R-DRI(OFFSET)	-32~+32	0
F26	B-DRI(R2)	B-DRI(OFFSET)	-32~+32	0
F27	B-DRI(R)	B-DRI(OFFSET)	-32~+32	0
F28	B-DRI(B)	B-DRI(OFFSET)	-32~+32	0
F29	V-FREE	V-FREE	0/1	0
F30	GAMMA	GAMMA	0~3	0
F31	TRAP(TV)	TRAP-FINE	0~3	2
F32	TRAP(AV)	TRAP-FINE	0~3	2
F33	H-FREE	H-FREE	0/1	0
F34	1W(TV)	V.WINDOW	0/1	0
F35	1W(AV)	V.WINDOW	0/1	0
F36	YLPF	YSW-LPF	0/1	1
F37	BS-D	BS-DISCHARGE	0~3	0
F38	BS-C	BS-CHARGE	0~3	0
F39	SL(TV)	S-SLICE DOWN	0~3	0
F40	SL(AV)	S-SLICE DOWN	0~3	0
F41	SL(SAV)	S-SLICE DOWN	0~3	0
F42	SL(YUV)	S-SLICE DOWN	0~3	0
F43	AFC2	AFC2-G	0/1	0
F44	VD(TV)	VSYNC-DET	0/1	0
F45	VD(AV)	VSYNC-DET	0/1	0
F46	AS(TV)	AUTO-SLICE	0/1	0
F47	AS(AV)	AUTO-SLICE	0/1	0
F48	AS(SAV)	AUTO-SLICE	0/1	0
F49	AS(YUV)	AUTO-SLICE	0/1	0
F50	FBP(TV)	FBP VTH	0/1	0
F51	FBP(AV)	FBP VTH	0/1	0
F52	FBP(SAV)	FBP VTH	0/1	0
F53	FBP(YUV)	FBP VTH	0/1	0
F54	C.CLIP LEVEL	C.CLIP LEVEL	0/1	0
F55	PSW	PSW	0/1	0
F56	FAO-VOL	VOL	0~63	60

Second Stage (Continued)

Data	Service Mode	Function	Range	Default Data
F57	CP	CHARGE PUMP	0/1	0
F58	CC LEVEL	CC LEVEL	0/1	0
F59	OSD POS	OSD POS	0/1	0
F60	OFFSET-ADJ-COL	COLOR	-32~+32	0
F61	OFFSET-ADJ-TINT	TINT	-32~+32	0
F62	OFFSET-ADJ-TINT-YUV	BASEBAND-TINT	-32~+32	0
F63	TIMER4-LOW SPEED	TIMER4 VALUE	0~225	50
F64	TIMER4-HIGH SPEED	TIMER4 VALUE	0~225	125
F65	R-CUT-YUV	R-CUT(OFFSET)	-63~+63	0
F66	G-CUT-YUV	G-CUT(OFFSET)	-63~+63	0
F67	B-CUT-YUV	B-CUT(OFFSET)	-63~+63	0
F68	R-DRI-YUV	R-DRI(OFFSET)	-63~+63	0
F69	B-DRI-YUV	B-DRI(OFFSET)	-63~+63	0
F70	CLOCK-ADJ		0~25	25

Third Stage

Data	OPTION FUNCTION	DATA = "0"	DATA = "1"	Default Data
001	DEMO	DEMO DISABLE	ENABLE	1
002	DOWNLOAD	V-CHIP OP DISABLE	ENABLE	0
003	V-CHIP	V-CHIP DISABLE	ENABLE	0
004	SPEAKER	SPEAKER DISABLE	ENABLE	1
005	FAO	FAO DISABLE	ENABLE	1
006	P.PREF	P.PREF DISABLE	ENABLE	1
007	UNIV+	UNIV+ DISABLE	ENABLE	1
008	VIEW TIMER	VIEW TIMER DISABLE	ENABLE	1
009	EZ-SETUP	EZ-SETUP	AUTO PRESET	0
010	* PON-CH	POWER-ON DISABLE	ENABLE	0
011	FAV-COL	FAV-COL	COL-TEMP	1
012	COMPONENT	COMPONENT DISABLE	ENABLE	1
013	AV	AV DISABLE	ENABLE	1
014	AV2	AV1	AV2	1
015	MTS	MTS DISABLE	ENABLE	1
016	TONE-CTRL	S-ADJ DISABLE	ENABLE	1
017	AUTO-OFF	AUTO-OFF DISABLE	ENABLE	1
018	INIT-LANG	ENGLISH	SPANISH	1
019	SETUP-FLAG	NO SET UP	AUTO SET UP	1
020	AV-FR	"0"=NO AV "1"=REAR "2"=FRONT "3"=REAR & FRONT		3
021	AV3/S-IN	AV3/S-IN DISABLE	ENABLE	0
022	COMB	COMB DISABLE	ENABLE	0
023	AUTO-INPUT	AUTO-INPUT DISABLE	ENABLE	1
024	CLOCK	CLOCK DISABLE	ENABLE	1
025	LED	SEMEX MODEL	SPC MODEL	0
026	FLAT	FLAT DISABLE	ENABLE	1
027	BASS BOOST	BASS BOOST DISABLE	ENABLE	0
028	DSE	DSE DISABLE	ENABLE	0
029	SRS	SRS DISABLE	ENABLE	0
030	WHITE-OUT	WHITE-OUT DISABLE	ENABLE	1

*POWER ON BY CH-UP/CH-DOWN KEY

ADJUSTMENT ITEM	BUS SET UP																																																														
	REFER AS BELOW	STEP RANGE	REFER AS BELOW																																																												
ADJUSTMENT POSITION																																																															
CONTROL		-																																																													
PRE-ADJUST REQUIREMENT		-																																																													
CONTENT		-																																																													
INPUT CONDITION	21FL94																																																														
OUTPUT	OSD CHECKING																																																														
	DATA SETUP FOR FIRST AND SECOND STAGE SERVICE DATA <table border="1"> <thead> <tr> <th>FUNCTION</th> <th>V05 SHARP</th> <th>F15 Y-DL(TV)</th> <th>F16 Y-DL(TV)</th> <th>F19 TINT(AV)</th> <th>F21 COL-AV</th> <th>F23 R-DIR2</th> <th>F24 R-DIR</th> <th>F25 R-DIR</th> <th>F26 R-DIR</th> <th>F27 B-DIR</th> <th>F28 B-DIR</th> </tr> </thead> <tbody> <tr> <td>21FL94</td> <td>50</td> <td>5</td> <td>2</td> <td>-7</td> <td>4</td> <td>+8</td> <td>+3</td> <td>-2</td> <td>-18</td> <td>-8</td> <td>+6</td> </tr> <tr> <td></td> <td></td> <td></td> <td></td> <td></td> <td></td> <td></td> <td></td> <td></td> <td></td> <td></td> <td></td> </tr> <tr> <td></td> <td></td> <td></td> <td></td> <td></td> <td></td> <td></td> <td></td> <td></td> <td></td> <td></td> <td></td> </tr> <tr> <td>DEF</td> <td></td> <td></td> <td></td> <td></td> <td></td> <td></td> <td></td> <td></td> <td></td> <td></td> <td></td> </tr> </tbody> </table>			FUNCTION	V05 SHARP	F15 Y-DL(TV)	F16 Y-DL(TV)	F19 TINT(AV)	F21 COL-AV	F23 R-DIR2	F24 R-DIR	F25 R-DIR	F26 R-DIR	F27 B-DIR	F28 B-DIR	21FL94	50	5	2	-7	4	+8	+3	-2	-18	-8	+6																									DEF											
FUNCTION	V05 SHARP	F15 Y-DL(TV)	F16 Y-DL(TV)	F19 TINT(AV)	F21 COL-AV	F23 R-DIR2	F24 R-DIR	F25 R-DIR	F26 R-DIR	F27 B-DIR	F28 B-DIR																																																				
21FL94	50	5	2	-7	4	+8	+3	-2	-18	-8	+6																																																				
DEF																																																															
	DATA SETUP FOR FIRST AND SECOND STAGE SERVICE DATA <table border="1"> <thead> <tr> <th>FUNCTION</th> <th>F30 GAMMA</th> <th>F35 1W(AV)</th> <th>F39 SL(TV)</th> <th>F40 SL(AV)</th> <th>F44 VD(TV)</th> <th>F46 AS(TV)</th> <th>F47 AS(AV)</th> <th>F56 FAO-VOL</th> <th>F60 CP</th> <th>F61 TINTOF</th> </tr> </thead> <tbody> <tr> <td>21FL94</td> <td>1</td> <td>1</td> <td>1</td> <td>1</td> <td>1</td> <td>1</td> <td>1</td> <td>58</td> <td>1</td> <td>+8</td> </tr> <tr> <td></td> <td></td> <td></td> <td></td> <td></td> <td></td> <td></td> <td></td> <td></td> <td></td> <td></td> </tr> <tr> <td></td> <td></td> <td></td> <td></td> <td></td> <td></td> <td></td> <td></td> <td></td> <td></td> <td></td> </tr> <tr> <td>DEF</td> <td></td> <td></td> <td></td> <td></td> <td></td> <td></td> <td></td> <td></td> <td></td> <td></td> </tr> </tbody> </table>			FUNCTION	F30 GAMMA	F35 1W(AV)	F39 SL(TV)	F40 SL(AV)	F44 VD(TV)	F46 AS(TV)	F47 AS(AV)	F56 FAO-VOL	F60 CP	F61 TINTOF	21FL94	1	1	1	1	1	1	1	58	1	+8																							DEF															
FUNCTION	F30 GAMMA	F35 1W(AV)	F39 SL(TV)	F40 SL(AV)	F44 VD(TV)	F46 AS(TV)	F47 AS(AV)	F56 FAO-VOL	F60 CP	F61 TINTOF																																																					
21FL94	1	1	1	1	1	1	1	58	1	+8																																																					
DEF																																																															
ADJUSTMENT PROCEDURE																																																															
HISTORY OF REVISION	SYMBOL	REVISED CONTENT,																																																													

ADJUSTMENT ITEM	OPTION SET UP																																																									
	REFER AS BELOW	STEP RANGE	REFER AS BELOW																																																							
ADJUSTMENT POSITION																																																										
CONTROL		-																																																								
PRE-ADJUST REQUIREMENT		-																																																								
CONTENT		-																																																								
INPUT CONDITION	21FL94																																																									
OUTPUT	OSD CHECKING																																																									
	BUS OPTION FOR THIRD STAGE SERVICE DATA <table border="1"> <thead> <tr> <th>FUNCTION</th> <th>001 DEMO</th> <th>002 DOWNLOAD</th> <th>003 V-CHIP</th> <th>004 SP</th> <th>005 FAO</th> <th>006 PPRF</th> <th>007 UNIV+</th> <th>008 VIEW</th> <th>009 EZ</th> <th>010 PON-CH</th> </tr> </thead> <tbody> <tr> <td>21FL94</td> <td>1</td> <td>0</td> <td>0</td> <td>1</td> <td>1</td> <td>1</td> <td>1</td> <td>1</td> <td>0</td> <td>0</td> </tr> <tr> <td></td> <td></td> <td></td> <td></td> <td></td> <td></td> <td></td> <td></td> <td></td> <td></td> <td></td> </tr> <tr> <td></td> <td></td> <td></td> <td></td> <td></td> <td></td> <td></td> <td></td> <td></td> <td></td> <td></td> </tr> <tr> <td>DEF</td> <td></td> <td></td> <td></td> <td></td> <td></td> <td></td> <td></td> <td></td> <td></td> <td></td> </tr> </tbody> </table>			FUNCTION	001 DEMO	002 DOWNLOAD	003 V-CHIP	004 SP	005 FAO	006 PPRF	007 UNIV+	008 VIEW	009 EZ	010 PON-CH	21FL94	1	0	0	1	1	1	1	1	0	0																							DEF										
FUNCTION	001 DEMO	002 DOWNLOAD	003 V-CHIP	004 SP	005 FAO	006 PPRF	007 UNIV+	008 VIEW	009 EZ	010 PON-CH																																																
21FL94	1	0	0	1	1	1	1	1	0	0																																																
DEF																																																										
ADJUSTMENT PROCEDURE	BUS OPTION FOR THIRD STAGE SERVICE DATA <table border="1"> <thead> <tr> <th>FUNCTION</th> <th>011 FAV-COL</th> <th>012 COMP</th> <th>013 AV</th> <th>014 AV2</th> <th>015 MTS</th> <th>016 TONE</th> <th>017 AUTO</th> <th>018 LAN</th> <th>019 SETUP</th> <th>020 AV-FR</th> </tr> </thead> <tbody> <tr> <td>21FL94</td> <td>1</td> <td>1</td> <td>1</td> <td>1</td> <td>1</td> <td>1</td> <td>1</td> <td>1</td> <td>1</td> <td>3</td> </tr> <tr> <td></td> <td></td> <td></td> <td></td> <td></td> <td></td> <td></td> <td></td> <td></td> <td></td> <td></td> </tr> <tr> <td></td> <td></td> <td></td> <td></td> <td></td> <td></td> <td></td> <td></td> <td></td> <td></td> <td></td> </tr> <tr> <td>DEF</td> <td></td> <td></td> <td></td> <td></td> <td></td> <td></td> <td></td> <td></td> <td></td> <td></td> </tr> </tbody> </table>			FUNCTION	011 FAV-COL	012 COMP	013 AV	014 AV2	015 MTS	016 TONE	017 AUTO	018 LAN	019 SETUP	020 AV-FR	21FL94	1	1	1	1	1	1	1	1	1	3																							DEF										
FUNCTION	011 FAV-COL	012 COMP	013 AV	014 AV2	015 MTS	016 TONE	017 AUTO	018 LAN	019 SETUP	020 AV-FR																																																
21FL94	1	1	1	1	1	1	1	1	1	3																																																
DEF																																																										
	BUS OPTION FOR THIRD STAGE SERVICE DATA <table border="1"> <thead> <tr> <th>FUNCTION</th> <th>021 AV3</th> <th>022 COMB</th> <th>023 A-IN</th> <th>024 CLOCK</th> <th>025 LED</th> <th>026 FLAT</th> <th>027 BASS</th> <th>028 DSE</th> <th>029 SRS</th> <th>030 WHITE</th> </tr> </thead> <tbody> <tr> <td>21FL94</td> <td>0</td> <td>0</td> <td>1</td> <td>1</td> <td>0</td> <td>1</td> <td>0</td> <td>0</td> <td>0</td> <td>0</td> </tr> <tr> <td></td> <td></td> <td></td> <td></td> <td></td> <td></td> <td></td> <td></td> <td></td> <td></td> <td></td> </tr> <tr> <td></td> <td></td> <td></td> <td></td> <td></td> <td></td> <td></td> <td></td> <td></td> <td></td> <td></td> </tr> <tr> <td>DEF</td> <td></td> <td></td> <td></td> <td></td> <td></td> <td></td> <td></td> <td></td> <td></td> <td></td> </tr> </tbody> </table>			FUNCTION	021 AV3	022 COMB	023 A-IN	024 CLOCK	025 LED	026 FLAT	027 BASS	028 DSE	029 SRS	030 WHITE	21FL94	0	0	1	1	0	1	0	0	0	0																							DEF										
FUNCTION	021 AV3	022 COMB	023 A-IN	024 CLOCK	025 LED	026 FLAT	027 BASS	028 DSE	029 SRS	030 WHITE																																																
21FL94	0	0	1	1	0	1	0	0	0	0																																																
DEF																																																										
HISTORY OF REVISION	SYMBOL	REVISED CONTENT,																																																								

ADJUSTMENT ITEM		H-POSITION	
ADJUSTMENT POSITION	V07	STEP RANGE	0-31
CONTROL	I ² C BUS CONTROL		
PRE-ADJUST REQUIREMENT	OPTION SET UP, BUS SET UP, CRT-PURITY		
CONTENT	US 4 CH LION HEAD (MONOSCOPE)		
INPUT CONDITION	AC 220V, US MAGNETIC FIELD		
OUTPUT	CONFIRMATION BY CRT SCREEN		
ADJUSTMENT PROCEDURE	<p>1. ADJUST THE V07 BUS DATA TO HAVE A BALANCE POSITION TO SPEC OF A=B.</p> <p>2. IF CANNOT MAKE IT TO A=B, ADJ FROM THE BEST POINT SO THAT B SLIDELY SMALLER THAN A</p> <div style="text-align: center;"> </div>		
HISTORY OF REVISION	SYMBOL	REVISED CONTENT,	

ADJUSTMENT ITEM		V-SIZE	
ADJUSTMENT POSITION	V09	STEP RANGE	0-63
CONTROL	I ² C CONTROL		
PRE-ADJUST REQUIREMENT	OPTION SET UP, BUS SET UP, CRT PURITY, V-PHASE, +B ADJUST		
CONTENT	US 4 CH LION HEAD		
INPUT CONDITION	AC 220V		
OUTPUT	CONFIRMATION BY CRT SCREEN		
ADJUSTMENT PROCEDURE	<p>ADJUST THE V09 BUS DATA UNTILL THE OVERSCAN BECOME AS SPECIFIED BELOW.</p> <p>CAUTION: - PLEASE AGING TV MORE THAN 10 MINUTES BEFORE ADJUSTMENT.</p>		
HISTORY OF REVISION	SYMBOL	REVISED CONTENT,	

ADJUSTMENT ITEM	V-PHASE	
ADJUSTMENT POSITION	V06	STEP RANGE 0-7
CONTROL	I ² C CONTROL	
PRE-ADJUST REQUIREMENT	OPTION SET UP, BUS SET UP, CRT-PURITY	
CONTENT	US 4 CH LION HEAD (MONOSCOPE PATTERN)	
INPUT CONDITION	220V, RF INPUT, ZERO MAGNETIC FIELD	
OUTPUT	CONFIRMATION ON CRT SCREEN	
ADJUSTMENT PROCEDURE	ADJUST V06 BUS DATA TO HAVE MOST ACCEPTABLE VERTICAL POSITION. THE MONOSCOPE PATTERN SHOULD BE BALANCE IN VERTICAL POSITION NOTE: THE DATA FOR V06 LIMIT AT <= 04, EVEN POSITION GOOD ENOUGH	
HISTORY OF REVISION	SYMBOL	REVISED CONTENT,

ADJUSTMENT ITEM	CLOSED CAPTION SET UP	
ADJUSTMENT POSITION	V18	STEP RANGE 0-255
CONTROL	I ² C CONTROL	
PRE-ADJUST REQUIREMENT	OPTION SET UP, BUS SET UP	
CONTENT	US 4 CH LION HEAD	
INPUT CONDITION	AC 220V	
OUTPUT	CONFIRMATION ON CRT DISPLAY.	
ADJUSTMENT PROCEDURE	1) BY SELECTING THE V18, BOX BLK TEXT WILL BE APPEARED. 2) ADJUST THE V18 BUS DATA TO HAVE A BALANCE POSITION TO SPEC OF A=B.	
HISTORY OF REVISION	SYMBOL	REVISED CONTENT,

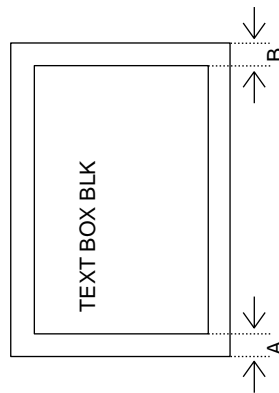

ADJUSTMENT ITEM		H-VCO	
ADJUSTMENT POSITION	V21	STEP RANGE	0-7
CONTROL	I ² C CONTROL		
PRE-ADJUST REQUIREMENT	OPTION SET UP, BUS SET UP		
CONTENT	NO SIGNAL (RASTER) CONDITION		
INPUT CONDITION	AC 220V		
OUTPUT	IC 801 PIN 11		
	(MANUAL ADJ) 1) GO TO SERVICE MODE, 2) GO TO SERVICE DATA V21, ADJ UNTIL FREQ AS BELOW (SELF ADJ) 1) GO TO SERVICE MODE, BY SELECTING THE SERVICE DATA V21 2) PRESS THE R/C TO OPERATE AUTO H-VCO, OSD APPEAR "OK" AT SCREEN 3) IF APPEAR "NG" PLS REPEAT STEP2		
ADJUSTMENT PROCEDURE	[CHECKING SPEC] FREQ = 15.735 ± 0.2 KHz		
HISTORY OF REVISION	SYMBOL	REVISED CONTENT,	

ADJUSTMENT ITEM		PIF-VCO	
ADJUSTMENT POSITION	V10	STEP RANGE	0-63
CONTROL	I ² C CONTROL		
PRE-ADJUST REQUIREMENT	OPTION SET UP, BUS SET UP		
CONTENT	NO SIGNAL (RASTER) CONDITION		
INPUT CONDITION	AC 220V		
OUTPUT	CONFIRMATION ON CRT DISPLAY (AUTO), IC801 PIN 2 VOLTAGE (MANUAL).		
	(AT SELF ADJUSTMENT MODE) 1) GO INTO SERVICE MODE, BY SELECTING THE SERVICE DATA V10 2) PRESS THE R/C FOR AUTO PIF-VCO KEY, OSD APPEAR "OK" AT SCREEN 3) IF APPEAR "NG" PLS REPEAT STEP2 (AT MANUAL ADJUSTMENT MODE) 1) GO INTO SERVICE MODE, BY SELECTING THE SERVICE DATA V10 2) ADJUST THE DATA UP/DOWN UNTIL IC801 PIN 2 VOLTAGE BECOME AS SPECIFIED BELOW		
ADJUSTMENT PROCEDURE	[CHECKING SPEC] 2.5 ± 0.5 V DC (CHECKING SPEC : 2.50 ± 1.5V)		
HISTORY OF REVISION	SYMBOL	REVISED CONTENT,	

ADJUSTMENT ITEM	RF-AGC	
ADJUSTMENT POSITION	V08	STEP RANGE 0-127
CONTROL	I ² C CONTROL	
PRE-ADJUST REQUIREMENT	OPTION SET UP, BUS SET UP	
CONTENT	US10CH HALF COLOR BAR	
INPUT CONDITION	RF INPUT FIELD STRENGTH 53dB_μV (FIX)	
OUTPUT	TUNER AGC TERMINAL (TP 201) OR CRT DISPLAY CONFIRMATION	
ADJUSTMENT PROCEDURE	<p>(AT SELF ADJUSTMENT MODE)</p> <ol style="list-style-type: none"> GO TO SERVICE MODE GO TO SERVICE DATA V08, PRESS R/C TO OPERATE AUTO-AGC KEY AND CONFIRM THE OK DISPLAY ON THE SCREEN. IF APPEAR NG PLS REPEAT STEP 2 AGAIN. <p>(AT MANUAL ADJUSTMENT MODE)</p> <ol style="list-style-type: none"> ADJUST THE V08 BUS DATA UNTIL AGC TERMINAL VOLTAGE BECOME MAXIMUM, THEN DROP 0.1V BELOW MAXIMUM VOLTAGE. CHANGE THE ANTENNA INPUT SIGNAL TO 63-67 dB_μV, AND MAKE SURE THERE IS NO NOISE CHANGE THE ANTENNA INPUT SIGNAL TO 90-95 dB_μV TO BE SURE THAT THERE IS NO CROSS MODULATION BEAT. 	
HISTORY OF REVISION	SYMBOL	REVISED CONTENT,

ADJUSTMENT ITEM	SCREEN	
ADJUSTMENT POSITION	V11, V12, V13	STEP RANGE 0-255
CONTROL	I ² C CONTROL	
PRE-ADJUST REQUIREMENT	OPTION SET UP, BUS SET UP	
CONTENT	WINDOW PATTERN OR US4CH LION HEAD	
INPUT CONDITION	220V	
OUTPUT	CONFIRMATION ON CRT DISPLAY	
ADJUSTMENT PROCEDURE	<ol style="list-style-type: none"> IN SERVICE MODE, SET V04&V11&V12&V13 TO 127; V14&V15 TO 64, GET IN Y-MUTE BY R/C AND SET V19 TO "1", PICTURE APPEAR IN CUT-OFF CONDITION ADJUST THE SCREEN SO THAT CUT-OFF LINE APPEAR IN LOW BRIGHT, THEN JUDGE THAT WHETHER THE CUT-OFF LINE APPEAR IN RED OR GREEN OR BLUE COLOR, IN THIS CONDITION V11=R-CUTOFF, V12=G-CUTOFF, V13=B-CUTOFF. FIX THE DATA OF THE COLOR APPEAR IN CUTOFF LINE AND USE R/C TO ADJUST THE OTHER TWO CUT-OFF DATA SO THAT CUT-OFF LINE COLOR BECOME WHITE. TURN THE SCREEN VR OF FBT SO THAT CUT-OFF LINE JUST DISAPPEAR AND USE R/C TO SET V19 TO "0", NEXT DISABLE THE Y-MUTE SO THAT PICTURE APPEAR IN NORMAL MODE. 	
HISTORY OF REVISION	SYMBOL	REVISED CONTENT,

ADJUSTMENT ITEM		WHITE BALANCE	
ADJUSTMENT POSITION	V14,V15,V11,V12,V13	STEP RANGE	0-127, 0-255
CONTROL	I ² C BUS CONTROL		
PRE-ADJUST REQUIREMENT	OPTION SET UP, BUS SET UP, SCREEN		
CONTENT	23CH 501RE WINDOW PATTERN		
INPUT CONDITION	220V		
OUTPUT	CRT SCREEN DISPLAY.		
ADJUSTMENT PROCEDURE	<p>1) WHITE (HIGH BEAM) FIRST LET THE GUN POINT AT BLACK POSITION (AS DRAWING ATTACH), ADJ V04 UNTIL BRIGHTNESS Y BECOME 5 cd/m², THEN LET THE GUN POINT AT WHITE POSITION (AS DRAWING ATTACH), ADJUST V01 UNTIL BRIGHTNESS Y BECOME 150 cd/m², ADJUST THE BUS DATA OF V14 (R DRIVE), V15(B DRIVE) UNTIL THE AXIS OF COLOR TEMPERATURE BECOME X=0.273, Y=0.280</p> <p>2) BLACK (LOW BEAM) LET THE GUN POINT AT BLACK POSITION, IF THE VALUE SHIFTED AWAY FROM THE DATA ADJUSTED IN STEP 1), ADJUST AGAIN THE TWO SERVICE DATA WHICH HAVE CHOSEN AT SCREEN ADJUST SO THAT TO OBTAIN THE SIMILAR AXIS AS ABOVE. *WARNING: DO NOT DISTURB THE MINI STEP GUN DATA DURING THIS ADJUSTMENT. **REPEAT STEP 1), 2) TO GET A REGULATED POSITION.</p>		
HISTORY OF REVISION	<p>[CHECKING CONFIRMATION] X=0.273, Y=0.280 (11,600°K + 1 MPCD)</p>		
SYMBOL	REVISED CONTENT,		

20-1

ADJUSTMENT ITEM		SUB-BRIGHT	
ADJUSTMENT POSITION	V04	STEP RANGE	0-255
CONTROL	I ² C CONTROL		
PRE-ADJUST REQUIREMENT	OPTION SET UP, BUS SET UP, SCREEN, WHITE BALANCE		
CONTENT	WINDOW PATTERN		
INPUT CONDITION	220V		
OUTPUT	CRT SCREEN DISPLAY.		
ADJUSTMENT PROCEDURE	<p>1) LET THE GUN POINT AT BLACK POSITION (AS ATTACH DRAWING), ADJUST V04 BUS DATA UNTIL BRIGHTNESS Y=0.5 cd/m², THEN STEP DOWN MORE 4 STEP</p>		
HISTORY OF REVISION	<p>[VOLTAGE CONFIRMATION] BRIGHTNESS Y=0.5 cd/m², THEN STEP DOWN MORE 4 STEP</p>		
SYMBOL	REVISED CONTENT,		

20-2

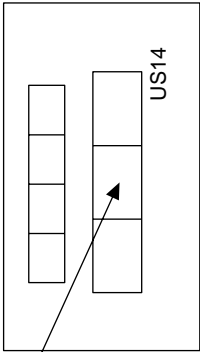
ADJUSTMENT ITEM	SUB-PICTURE	
ADJUSTMENT POSITION	V01	STEP RANGE 0-127
CONTROL	I ² C BUS CONTROL	
PRE-ADJUST REQUIREMENT	OPTION SET UP, BUS SET UP, SCREEN, WHITE BALANCE, SUB-BRIGHTNESS	
CONTENT	WINDOW PATTERN	
INPUT CONDITION	220V	
OUTPUT	CRT SCREEN DISPLAY.	
ADJUSTMENT PROCEDURE	<p>1) LET THE GUN POINT AT WHITE POSITION (AS ATTACH DRAWING), ADJUST V01 BUS DATA UNTIL BRIGHTNESS Y=150 cd/m². NOTE: ALLOWABLE DATA FOR V01 IS >= 90, EVEN Y CAN'T MATCH THE SPEC</p> 	
HISTORY OF REVISION	SYMBOL	REVISED CONTENT,

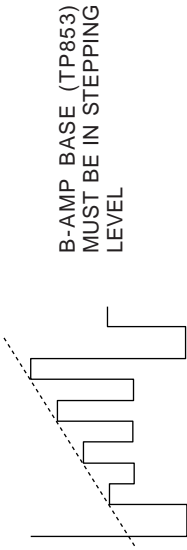
ADJUSTMENT ITEM	SUB-TINT	
ADJUSTMENT POSITION	V02	STEP RANGE 0-127
CONTROL	I ² C CONTROL	
PRE-ADJUST REQUIREMENT	OPTION SET UP, BUS SET UP, VCO ADJ, RF-AGC	
CONTENT	US 10 CH HALF COLOR BAR PATTERN	
INPUT CONDITION	220V	
OUTPUT	B-AMP TR BASE (TP853) CONFIRM WITH OSCILLOSCOPE	
ADJUSTMENT PROCEDURE	<p>1) GET IN Y-MUTE FUNCTION BY R/C. 2) ADJUST THE V02 BUS DATA TO GET A WAVEFORM AS BELOW. 3) DISABLE THE Y-MUTE **PLS TAKE NOTE THAT SERVICE MODE DATA F61 NEED TO SET +8</p> 	
HISTORY OF REVISION	SYMBOL	REVISED CONTENT,

SUB-COLOR	
ADJUSTMENT ITEM	
ADJUSTMENT POSITION	V03
CONTROL	STEP RANGE
PRE-ADJUST REQUIREMENT	0-127
CONTENT	i ² C BUS CONTROL
INPUT CONDITION	OPTION SET UP, BUS SET UP, VCO ADJ, RF-AGC, SUB-PICT, SUB-TNT
OUTPUT	US 10 CH HALF COLOR BAR PATTERN
	220V
	R-AMP TR BASE (TP851) CONFIRM WITH OSCILLOSCOPE
	1) SET THE V03 BUS DATA TO GET A WAVEFORM AS BELOW 2) THIS WAVEFORM SHOWS THAT THE 75% WHITE & RED PORTIONS OF COLOR BAR BEAT AT THE SAME LEVEL *PLEASE TAKE NOTE THAT SERVICE DATA F60 MUST SET TO +10
ADJUSTMENT PROCEDURE	
	[CHECKING CONFIRMATION]
HISTORY OF REVISION	SYMBOL REVISED CONTENT,

X-RAY PROTECTION OPERATING CONFIRMATION					
ADJUSTMENT ITEM					
ADJUSTMENT POSITION	STEP RANGE				
CONTROL	-				
PRE-ADJUST REQUIREMENT	AFTER ALL ADJUSTMENT FINISHED.				
CONTENT	US 4 CH LION HEAD (MONOSCOPE PATTERN)				
INPUT CONDITION	AC 220V, RF INPUT				
OUTPUT	CONFIRMATION BY THE CRT				
	SET THE USER CONTROL TO SHIPMENT POSITION.				
	[VOLTAGE CONFIRMATION] CHECK THE VOLTAGE OF P603 PIN 3 AS SPECIFIED BELOW.				
	[OPERATION CONFIRMATION] SUPPLY THE DC VOLTAGE TO P603 PIN 3 AND MAKE SURE THE PROJECTOR IS FUNCTIONED. HORIZONTAL OSCILATION STOP AND PICTURE DISAPPEAR.				
ADJUSTMENT PROCEDURE	[RECOVER INFORMATION] PULL OUT THE AC CORD.				
	[CAUTION] FROM THE RECOVER CONFIRMATION MENTIONED ABOVE, THE AC CODE MUST BE PULLED OUT AT LEAST 4 SECOND BEFORE PLUGGING IN AGAIN.(IN ORDER TO MAKE SURE THE μ-COM HAS BEEN RESET.)				
	[VOLTAGE CONFIRMATION]				
	<table border="1"> <tr> <td>TP VOLTAGE</td> <td>OPERATION VOLTAGE</td> </tr> <tr> <td>26± 1.1V DC</td> <td>27V</td> </tr> </table>	TP VOLTAGE	OPERATION VOLTAGE	26± 1.1V DC	27V
TP VOLTAGE	OPERATION VOLTAGE				
26± 1.1V DC	27V				
HISTORY OF REVISION	SYMBOL REVISED CONTENT,				

ADJUSTMENT ITEM	MS LEVEL ADJUSTMENT	
ADJUSTMENT POSITION	M01	STEP RANGE 0-15
CONTROL	I ² C BUS CONTROL	
PRE-ADJUST REQUIREMENT	OPTION SET UP, BUS SET UP, VCO ADJ, RF-AGC	
CONTENT	MONORAL SIGNAL (400HZ 100% MODULATION)	
INPUT CONDITION	AC 220V, RF INPUT	
OUTPUT	IC 3001 39 PIN	
ADJUSTMENT PROCEDURE	1) SET THE SOUND VOLUME CONTROL MORE THAN 1. 2) ADJUST BUS DATA OF M01 UNTIL THE VOLTAGE OF 39 PIN BE-COME AS SPECIFIED BELOW.	
HISTORY OF REVISION	SYMBOL	REVISED CONTENT, [CHECKING SPEC] 490 ± 10mVrms (CHECKING SPEC :490 ± 20mVrms)

ADJUSTMENT ITEM	HIGH VOLTAGE	
ADJUSTMENT POSITION	-	STEP RANGE -
CONTROL	-	
PRE-ADJUST REQUIREMENT	AFTER ALL ADJUSTMENT FINISHED.	
CONTENT	US 4 CH LION HEAD (MONOSCOPE PATTERN)	
INPUT CONDITION	AC 220V, RF INPUT	
OUTPUTΩ	CRT ANODE VOLTAGE	
ADJUSTMENT PROCEDURE	SET THE USER CONTROL TO SHIPMENT SETTING POSITION. PUSH ON Y-MUTE BY R/C CONFIRM THE VOLTAGE OF CRT ANODE BY HIGH VOLTAGE METER AND MAKE SURE THE READING IS AS BELOW.	
HISTORY OF REVISION	SYMBOL	REVISED CONTENT, [CAUTION POINT] USE ELECTROSTATIC HI-VOLTAGE METER AND FOLLOW THE UL/DHHS STANDARD TO MAKE CORRECTION AND CONTROL.

HIGH VOLTAGE
 BELOW 30kV

SEPARTION ADJUSTMENT		
ADJUSTMENT ITEM		
ADJUSTMENT POSITION	M04, M05	STEP RANGE 0-63
CONTROL	I ² C BUS CONTROL	
PRE-ADJUST REQUIREMENT	OPTION SET UP, BUS SET UP, VCO ADJ, RF-AGC, MS-LEVEL, MTS-VCO, FILTER	
CONTENT	STEREO SIGNAL SIGNAL 1.: MODULATION 30%, L-CH ONLY, NR-ON, 300HZ SIGNAL 2.: MODULATION 30%, L-CH ONLY, NR-ON, 3kHz	
INPUT CONDITION	RF INPUT	
OUTPUT	IC 3001 39 PIN	
ADJUSTMENT PROCEDURE	<p>1) INPUT SIGNAL 1, ADJUST BUS DATA OF M04 UNTIL THE OF 39 PIN BECOME MINIMUM LEVEL.</p> <p>2) INPUT SIGNAL 2, ADJUST BUS DATA OF M05 UNTIL THE AC VOLTAGE OF 39 PIN BECOME MINIMUM LEVEL.</p> <p>3) REPEAT STEP 1) AND 2).</p> <p>SET THE SOUND VOLUME TO MAXIMUM THEN MAKE SURE THE READING FROM THE SPEAKER TERMINAL MUST BE OVER THE SPEC AS SPECIFIED BELOW.</p>	
HISTORY OF REVISION	[CHECKING SPEC] OVER 25 dB (CHECKING SPEC : OVER 20 dB)	SYMBOL REVISED CONTENT,

WAVEFORMS

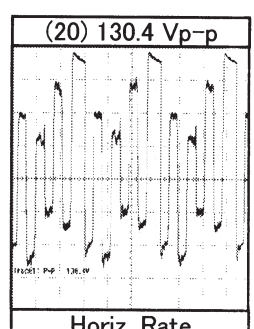
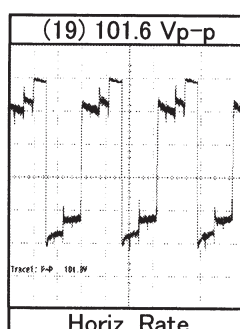
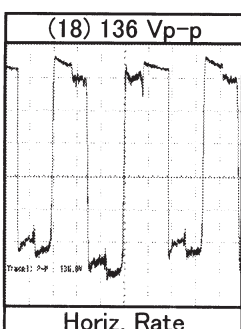
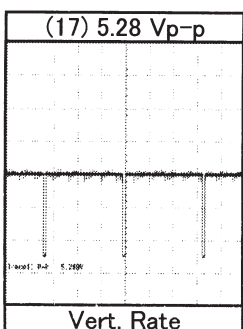
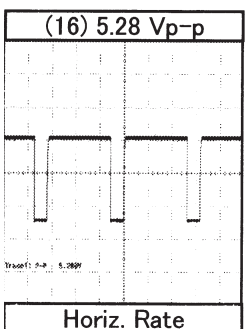
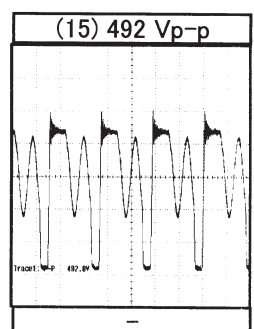
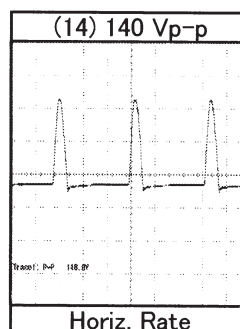
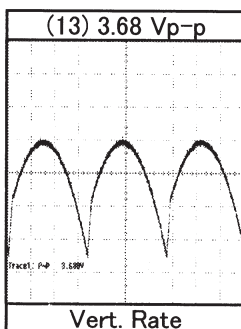
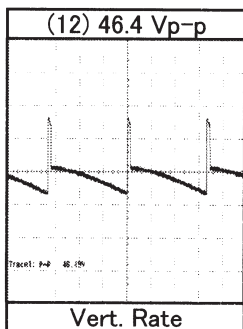
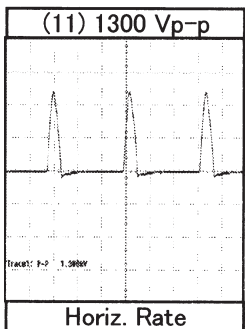
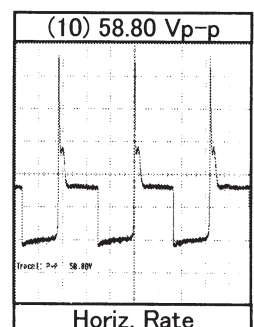
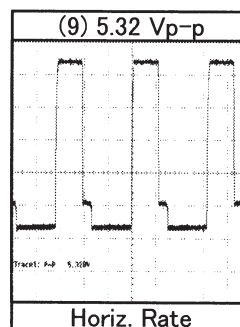
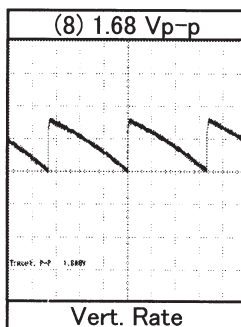
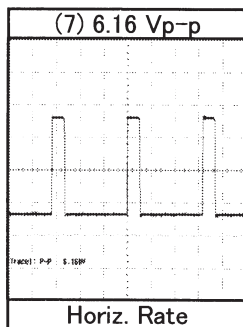
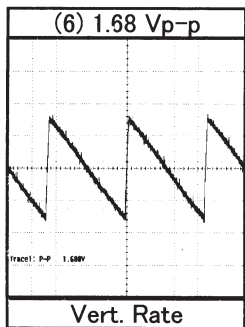
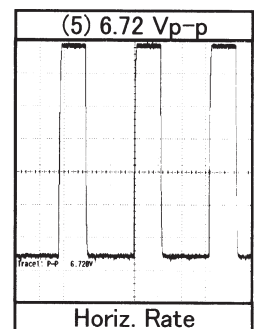
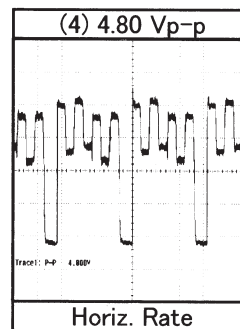
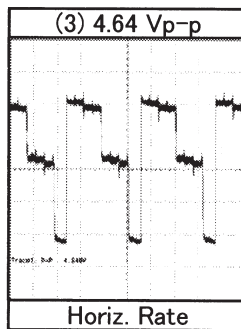
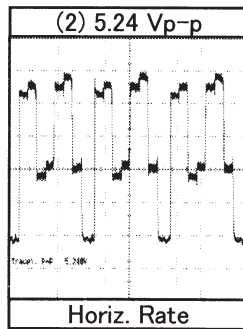
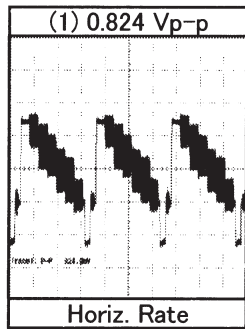

CHASSIS LAYOUT

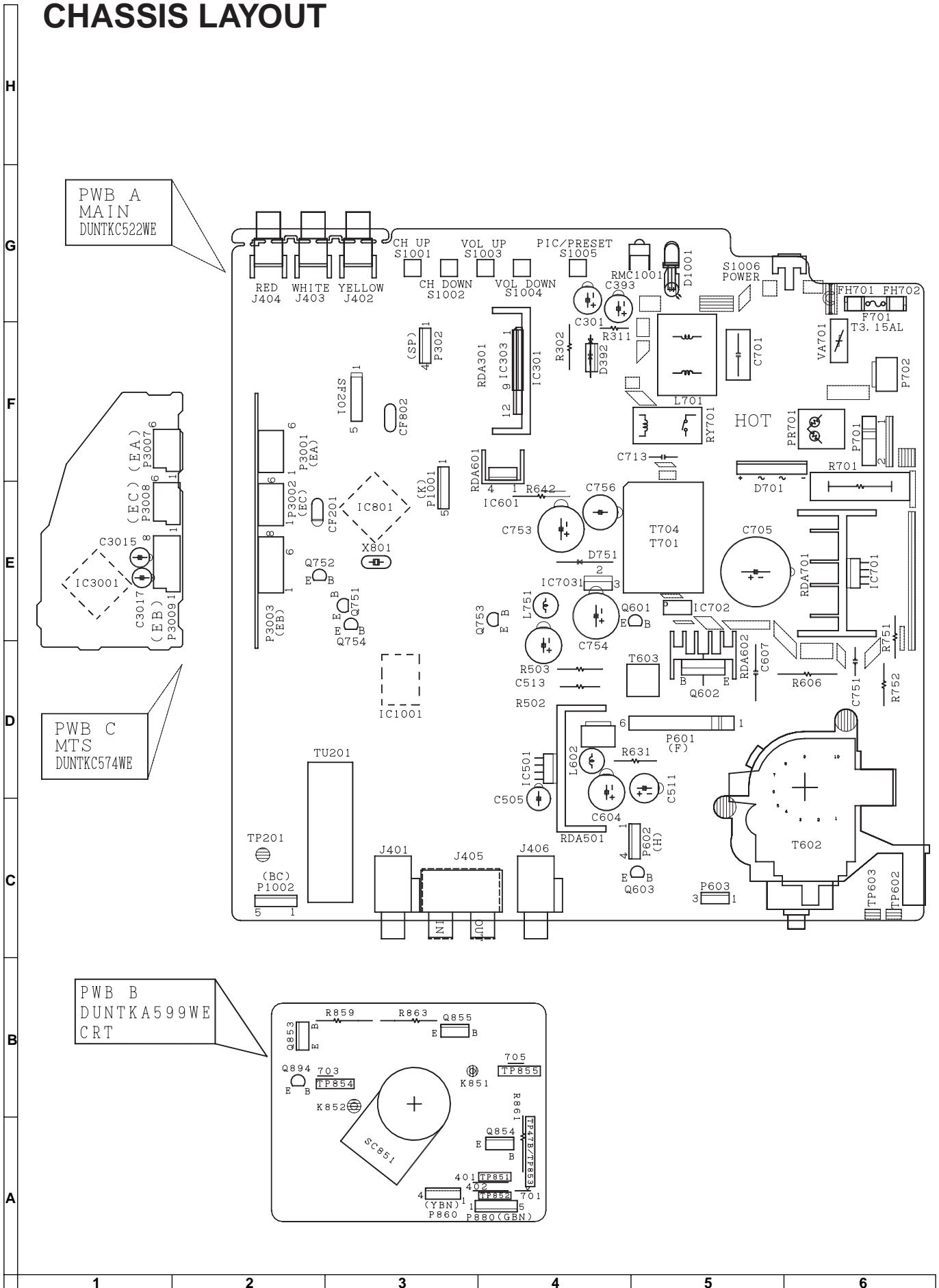

PWB A
MAIN
DUNTKC522WE

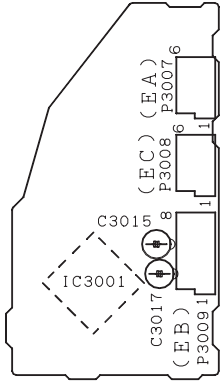

PWB C
MTS
DUNTKC574WE

PWB B
DUNTKA599WE
CRT

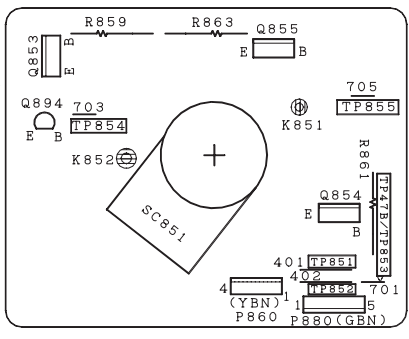

CRT BLOCK DIAGRAM

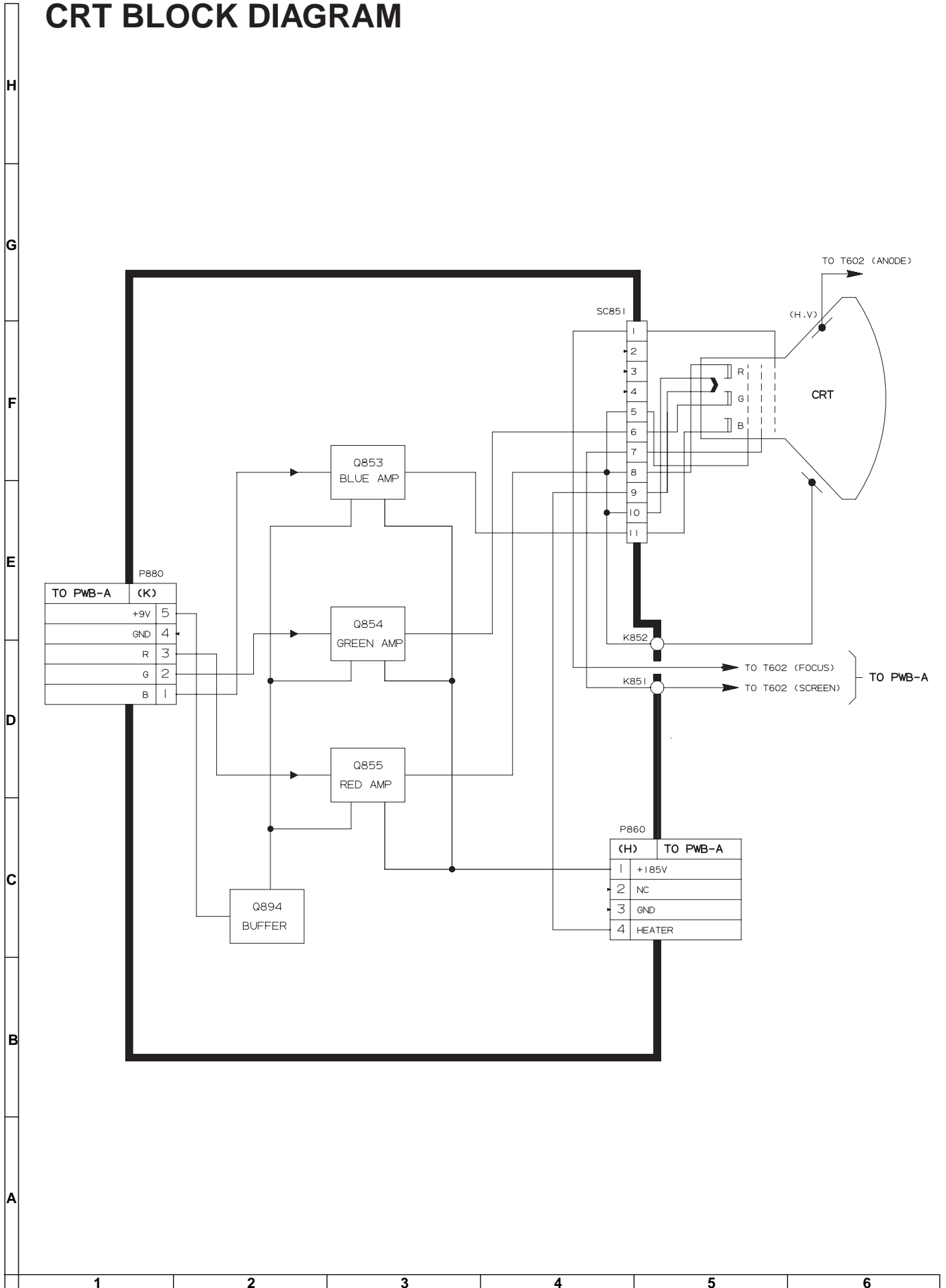

MAIN BLOCK DIAGRAM

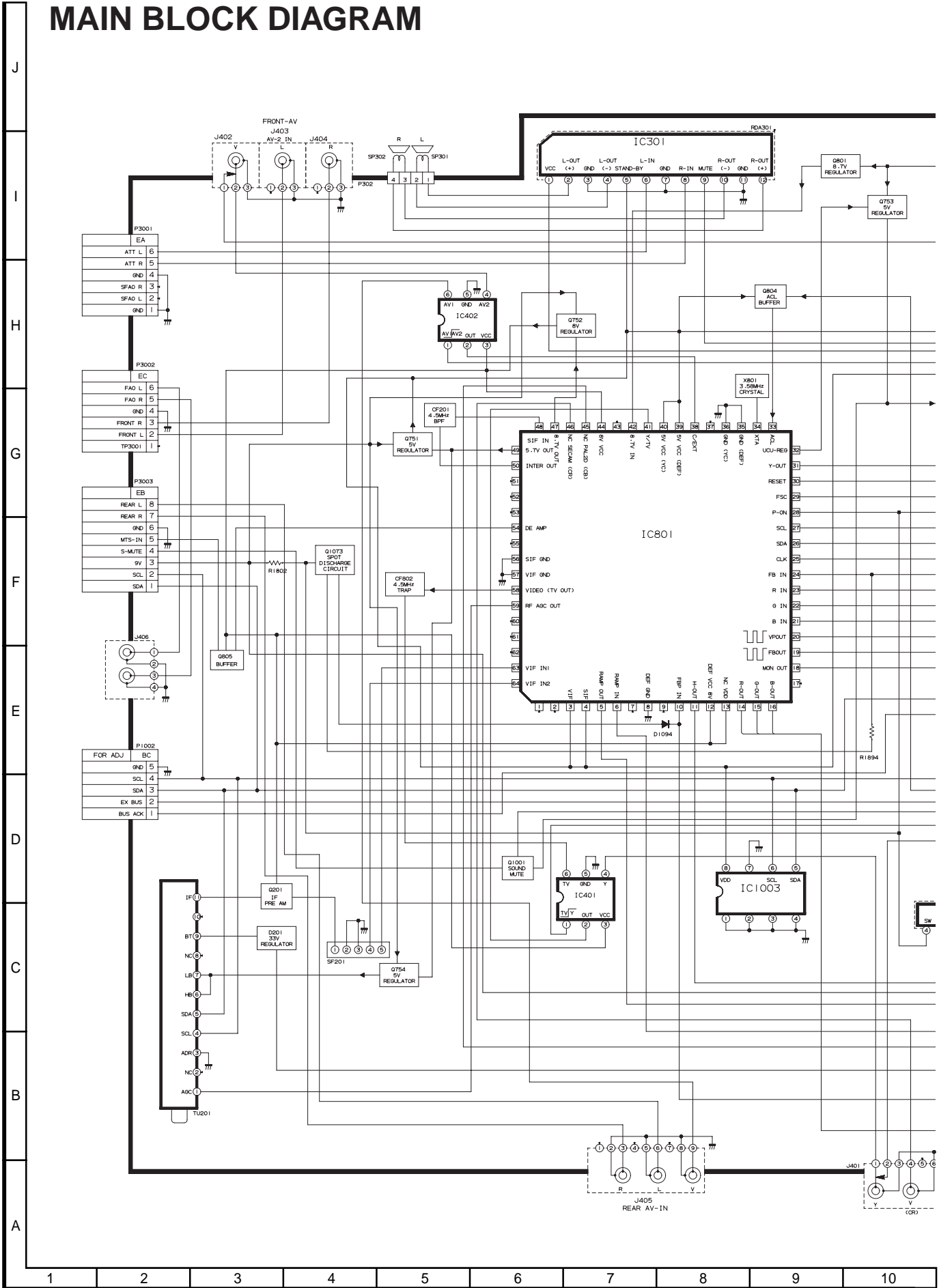

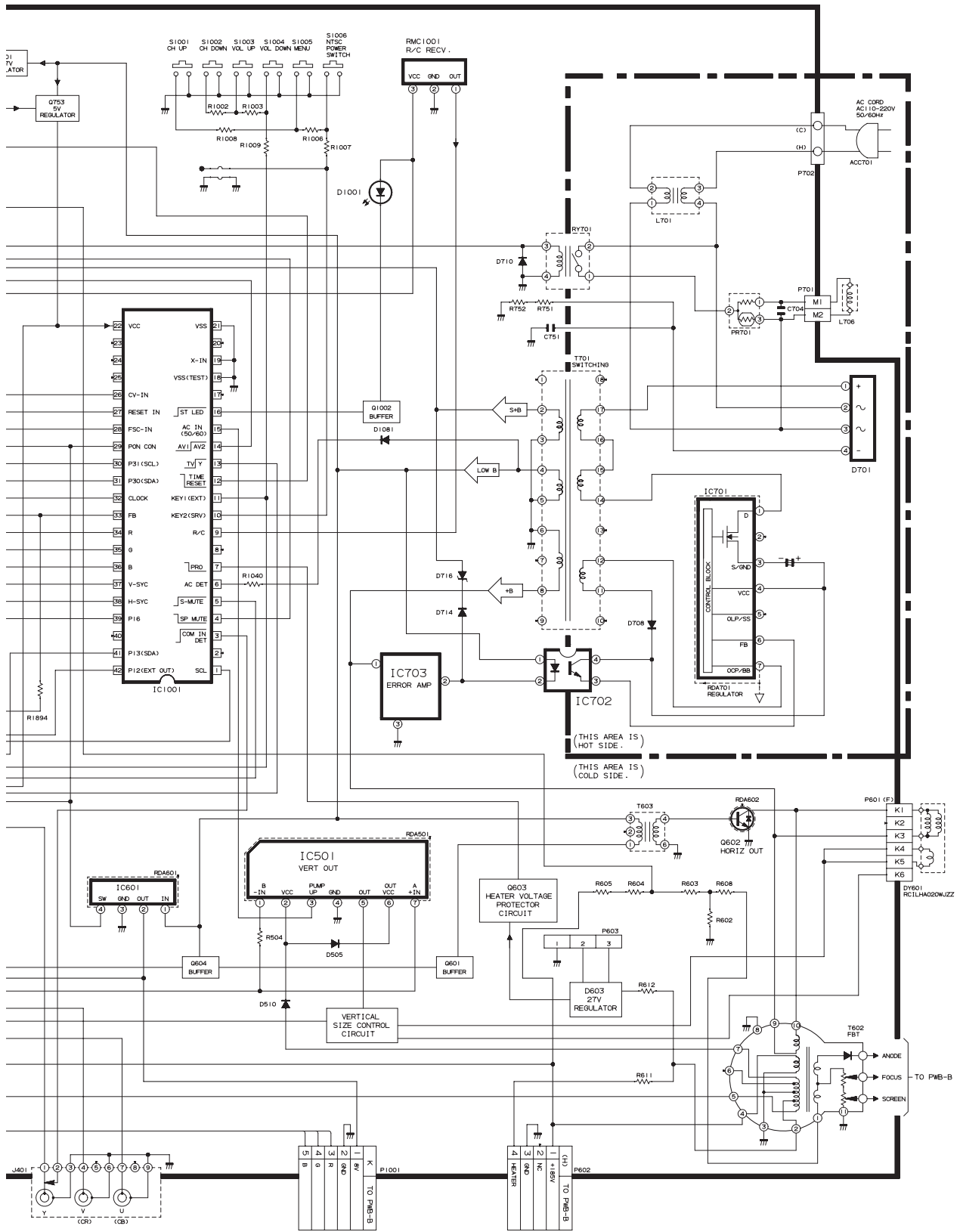

10	11	12	13	14	15	16	17	18	19
----	----	----	----	----	----	----	----	----	----

MTS BLOCK DIAGRAM

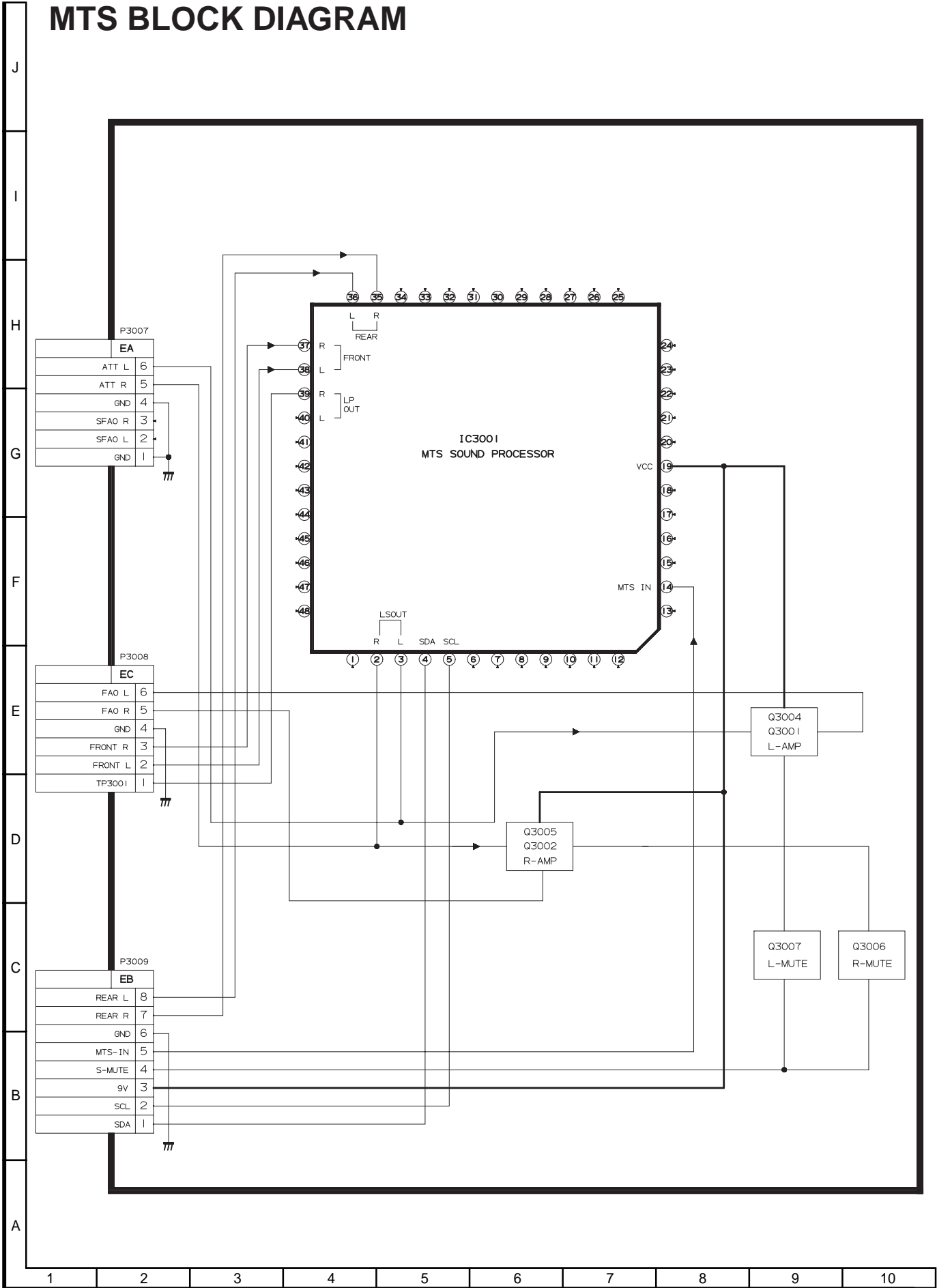

DESCRIPTION OF SCHEMATIC DIAGRAM

NOTES:

1. The unit of resistance "ohm" is omitted.
($K=k\Omega=1000\Omega$, $M=M\Omega$)
2. All resistors are 1/16 watt, unless otherwise noted.
3. All capacitors are μF , unless otherwise noted.
($P=pF=\mu\mu F$)
4. (G) indicates $\pm 2\%$ tolerance may be used.
5. $\overline{\text{H}}$ indicates line isolated ground.

VOLTAGE MEASUREMENT CONDITIONS:

1. All DC voltages are measured with DVM connected between points indicated and chassis ground, line voltage set at 120V AC and all controls set for normal picture unless otherwise indicated.
2. All voltages measured with 1000 μ V B & W or Color signal.

WAVEFORM MEASUREMENT CONDITIONS:

1. Photographs taken on a standard gated color bar signal, the tint setting adjusted for proper color. The wave shapes at the red, green and blue cathodes of the picture tube depend on the tint, color level and picture control.
2.  indicates waveform check points (See chart, waveforms are measured from point indicated to chassis ground.)

 AND SHADED () COMPONENTS
= SAFETY RELATED PARTS.
 MARK= X-RAY RELATED PARTS.

DRGANNES MARQUES  ET HACHRES ():
PIECES RELATIVES A LA SECURITE.
MARQUE  : PIECS RELATIVE AUX RAYONS X.

This circuit diagram is a standard one, printed circuits may be subject to change for product improvement without prior notice.

SCHEMATIC DIAGRAM: MAIN Unit

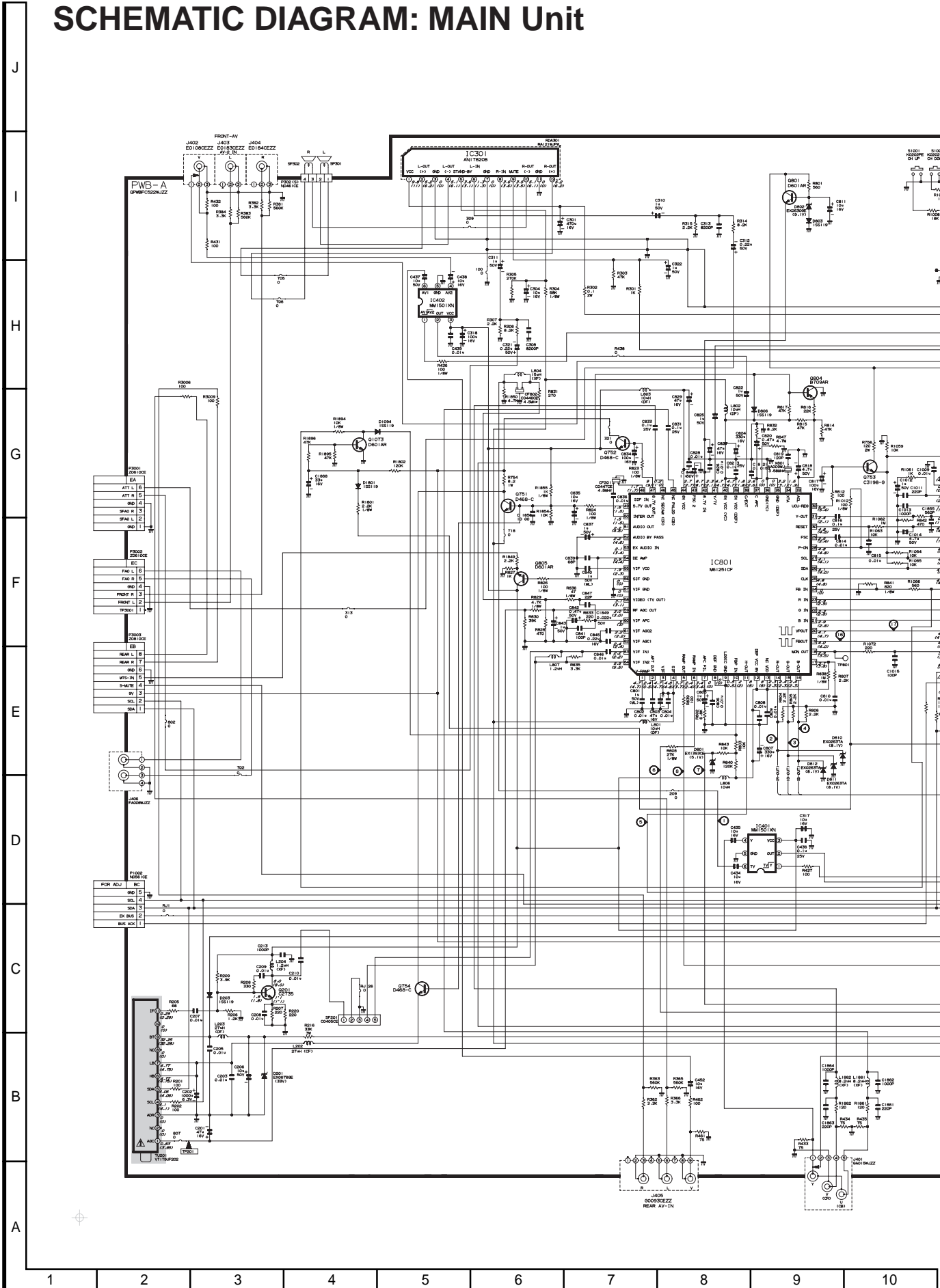



▲ AND SHADED: SAFETY RELATED PARTS.
 ▲ MARK: X-RAY RELATED PARTS.

NOTE: 1. THE UNIT OF RESISTANCE "OHM" IS OMITTED.
 IC# 1000 OHMS W/RES/20W.
 2. ALL RESISTORS ARE 1/4W WATT UNLESS OTHERWISE NOTED.
 3. UNIT OF ALL CAPACITORS ARE P WITH PREFIX SYMBOL.
 (u, n, p, etc.).

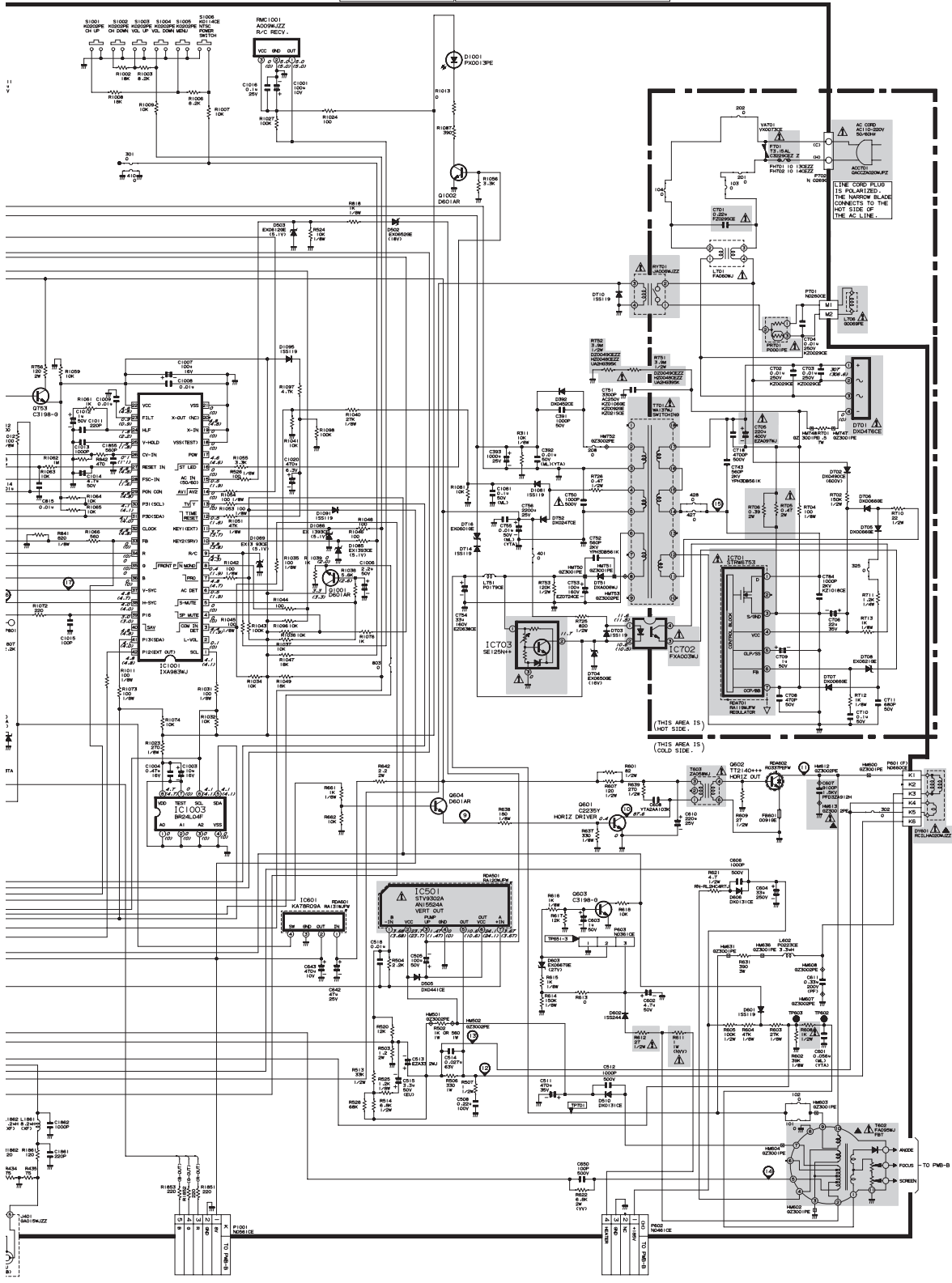

10	11	12	13	14	15	16	17	18	19
----	----	----	----	----	----	----	----	----	----

SCHEMATIC DIAGRAM: CRT Unit

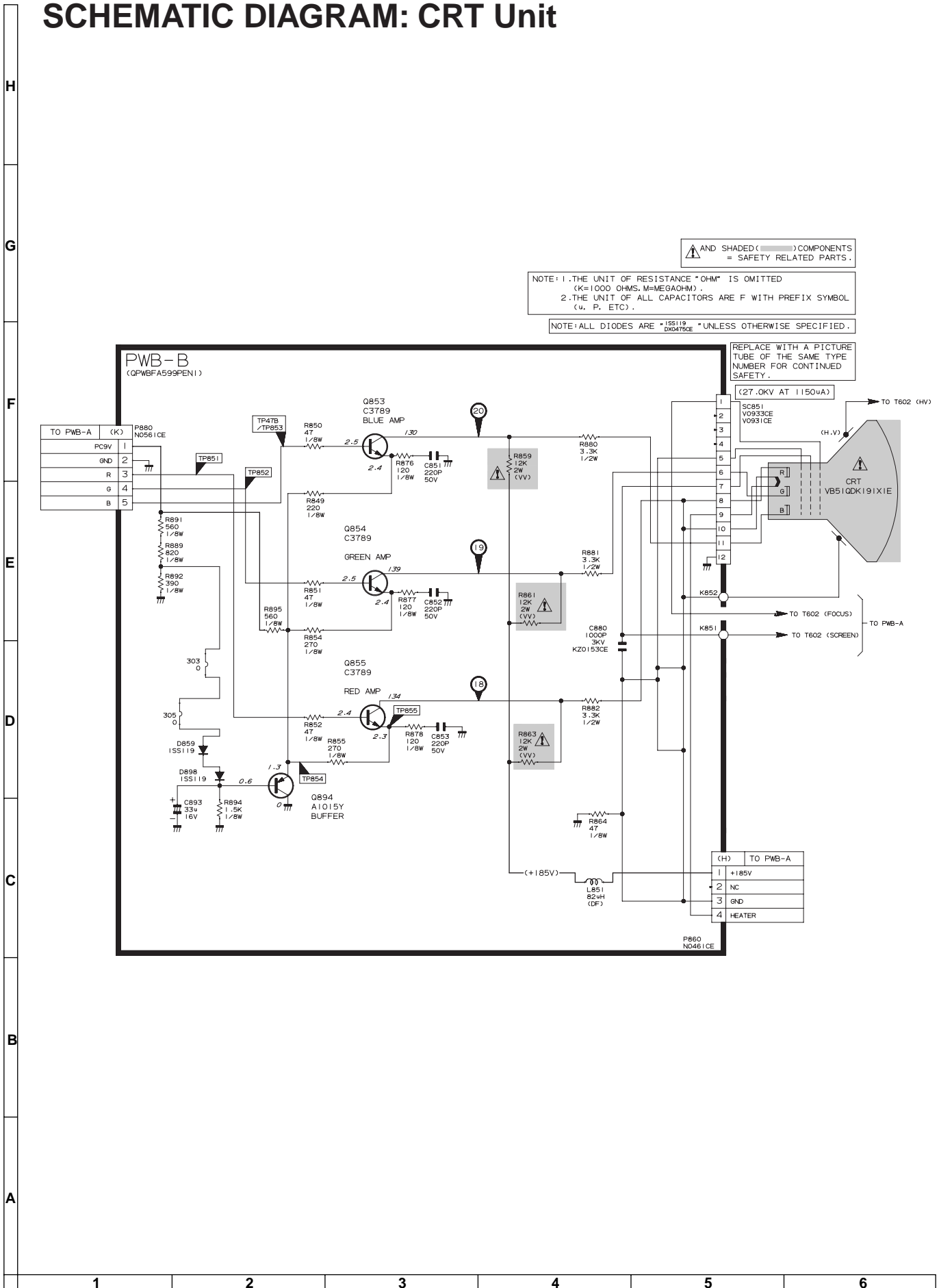

H
G
F
E
D
C
B
A

1 2 3 4 5 6

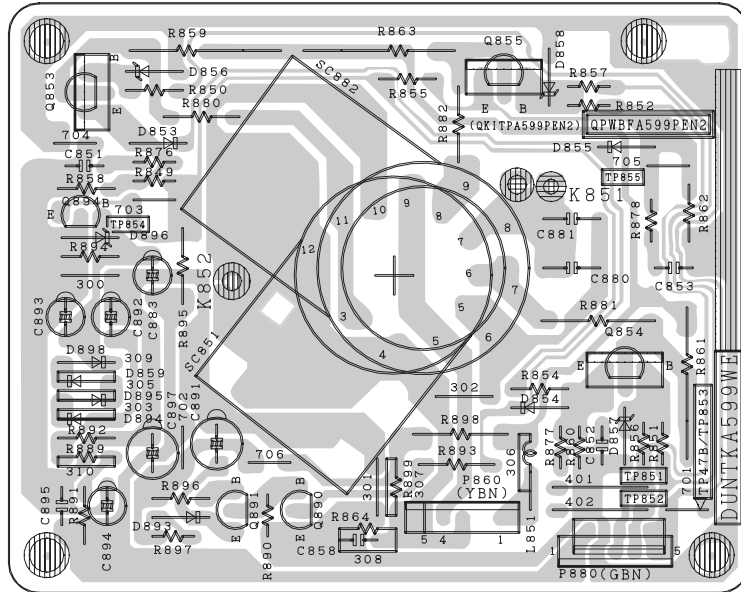

PWB-B: CRT Unit (Wiring Side)

REPLACEMENT PARTS LIST

PARTS REPLACEMENT

Replacement parts which have these special safety characteristics are identified in this manual; electrical components having such features are identified by "△" in the Replacement Parts Lists.

The use of a substitute replacement part which does not have the same safety characteristics as the factory recommended replacement parts shown in this service manual may create shock, fire or other hazards.

"HOW TO ORDER REPLACEMENT PARTS"

To have your order filled promptly and correctly, please furnish the following informations.

1. MODEL NUMBER
2. REF. NO.
3. PART NO.
4. DESCRIPTION

MARK ★ : SPARE PARTS-DELIVERY SECTION.

Ref. No.	Part No.	★	Description	Code
PICTURE TUBE				
△ L706	RCiLG0069PEZZ	X	Degaussing Coil	AH
	VB51QDK191X1E	X	Picture Tube	BV
	QEARCA012WJZZ	X	Grounding Strap	AC

PRINTED WIRING BOARD ASSEMBLIES (NOT REPLACEMENT ITEM)

PWB-A	DUNTKC522WEA0	-	MAIN Unit	—
PWB-B	DUNTKA599WED5	-	CRT Unit	—
PWB-C	DUNTKC574WEA0	-	MTS Unit	—

DUNTKC522WEA0 PWB-A MAIN UNIT

TUNER

NOTE: THE PARTS HERES SHOWN ARE SUPPLIED AS AN ASSEMBLY NOT INDEPENDENTLY.

△ TU201	VTUVT1T5UF202	X	VHF Tuner	AP
---------	---------------	---	-----------	----

INTEGRATED CIRCUITS

IC301	VHiAN17820B-1	X	AN17820B	AG
IC401	VHiMM1501XN-1Y	X	MM1501XN	AC
IC402	VHiMM1501XN-1Y	X	MM1501XN	AC
△ IC501	VHiSTV9302A-1	X	STV9302A	AD
IC601	VHiKA78R09AP1	X	KA78R09AP	AC
△ IC701	VHiSTRW6753-1	X	STRW6753	AG
△ IC702	RH-FXA003WJZZ	X	FXA003WJ	AB
△ IC703	VHiSE125N++F	X	SE125N++	AD
IC801	VHiM61251CF1EQ	X	M61251CF1	AN
IC1001	RH-iXA983WJZZ	X	IXA983WJ	AK
IC1003	VHiBR24L04F-1Y	X	BR24L04F	

TRANSISTORS

Q201	VS2SC2735//1EY	X	2SC2735	AB
Q601	VS2SC2235Y//1E+	X	2SC2235Y	
Q602	VSTT2140+++F	X	TT2140+++	AD
Q603	VS2SC3198-G-1+	X	2SC3198-G	AB

Ref. No.	Part No.	★	Description	Code
Q604	VS2SD601AR/-1Y	X	2SD601AR	AB
Q751	VS2SD468-C/-1+	X	2SD468-C	AB
Q752	VS2SD468-C/-1+	X	2SD468-C	AB
Q753	VS2SC3198-G-1+	X	2SC3198-G	AB
Q754	VS2SD468-C/-1+	X	2SD468-C	AB
Q801	VS2SD601AR/-1Y	X	2SD601AR	AB
Q804	VS2SB709AR/-1Y	X	2SB709AR	AB
Q805	VS2SD601AR/-1Y	X	2SD601AR	AB
Q1001	VS2SD601AR/-1Y	X	2SD601AR	AB
Q1002	VS2SD601AR/-1Y	X	2SD601AR	AB
Q1073	VS2SD601AR/-1Y	X	2SD601AR	AB

DIODES AND LED

D201	RH-EX0676GEZZY	X	Zener, EX0676GE	AB
D203	VHD1SS119//1Y	X	1SS119	AA
D392	RH-DX0452CEZZ	X	DX0452CE	
D502	RH-EX0652GEZZY	X	Zener, EX0652GE	AB
D503	RH-EX0612GEZZY	X	Zener, EX0612GE	AB
D505	RH-DX0441CEZZY	X	DX0441CE	AB
D510	RH-DX0131CEZZY	X	DX0131CE	AB
D601	VHD1SS119//1Y	X	1SS119	AA
D602	VHD1SS244//1Y	X	1SS244	AB
D603	RH-EX0667GEZZY	X	Zener, EX0667GE	
D606	RH-DX0131CEZZY	X	DX0131CE	AB
△ D701	RH-DX0476CEZZ	X	DX0476CE	AC
D702	RH-DX0490CEZZY	X	DX0490CE	AB
D703	VHD1SS119//1Y	X	1SS119	AA
D704	RH-EX0650GEZZY	X	Zener, EX0650GE	AB
D705	RH-DX0066GEZZY	X	DX0066GE	AB
D706	RH-DX0066GEZZY	X	DX0066GE	AB
D707	RH-DX0066GEZZY	X	DX0066GE	AB
D708	RH-EX0621GEZZY	X	Zener, EX0621GE	AB
D710	VHD1SS119//1Y	X	1SS119	AA
D714	VHD1SS119//1Y	X	1SS119	AA
D716	RH-EX0601GEZZY	X	Zener, EX0601GE	AB
D751	RH-DXA006WJZZ	X	DXA006WJ	AB
D752	RH-DX0247CEZZ	X	DX0247CE	
D801	RH-EX1393CEZZY	X	Zener, EX1393CE	AB
D802	RH-EX0630GEZZY	X	Zener, EX0630GE	AB
D803	VHD1SS119//1Y	X	1SS119	AA
D806	VHD1SS119//1Y	X	1SS119	AA
D810	RH-EX0263TAZZY	X	Zener, EX0263TA	AB
D811	RH-EX0263TAZZY	X	Zener, EX0263TA	AB
D812	RH-EX0263TAZZY	X	Zener, EX0263TA	AB
D1001	RH-PX0013PEZZ	X	PhotoDiode	AB
D1081	VHD1SS119//1Y	X	1SS119	AA
D1085	RH-EX1393CEZZY	X	Zener, EX1393CE	AB
D1086	RH-EX1393CEZZY	X	Zener, EX1393CE	AB
D1089	RH-EX1393CEZZY	X	Zener, EX1393CE	AB
D1091	VHD1SS119//1Y	X	1SS119	AA
D1094	VHD1SS119//1Y	X	1SS119	AA
D1095	VHD1SS119//1Y	X	1SS119	AA
D1801	VHD1SS119//1Y	X	1SS119	AA
VA701	RH-VX0073CEZZ	X	Varistor	AB

PACKAGED CIRCUITS

△ PR701	RMPTP0001PEZZ	X	Packaged Circuit	AE
△ R751	RR-DZ0049CEZZY	X	Resistor	AB
△ R752	RR-DZ0049CEZZY	X	Resistor	AB
X801	RCRSAA009WJZZ	X	Crystal, CRSAA009WJ	AC

FILTERS

CF201	RFiLC0447CEZZ	X	Filter, FiLC0447CE	AB
CF802	RFiLC0446CEZZ	X	Filter, FiLC0446CE	AB
SF201	RFiLC0405CEZZ	X	Filter, FiLC0405CE	AD

COILS

L202	VP-CF270K0000Y	X	Peaking, 27μH	AB
L203	VP-DF270K0000Y	X	Peaking, 27μH	AB
L204	VP-XF1R2K0000Y	X	Peaking, 1.2μH	AB
L602	RCiLP0223CEZZ	X	Coil, 3.3μH	AB
L701	RCiLFA060WJZZ	X	Coil, CiLFA060WJ	AD
L751	RCiLP0179CEZZ+	X	Coil, CiLP0179CE	AB
L801	VP-DF100K0000Y	X	Peaking, 10μH	AB

Ref. No.	Part No.	★	Description	Code	Ref. No.	Part No.	★	Description	Code
L802	VP-DF100K0000Y	X	Peaking, 10μH	AB	△ C705	RC-EZA097WJZZ	X	220 400V	AG
L803	VP-DF100K0000Y	X	Peaking, 10μH	AB	C706	VCEA0A1VW226M+X	22	35V Electrolytic	AB
L804	VP-XF150K0000Y	X	Peaking, 15μH	AB	C708	VCKYPA1HB471K+X	470p	50V Ceramic	AA
L806	VP-DF100K0000Y	X	Peaking, 10μH	AB	C709	VCEA9M1HW105M+X	1	50V Electrolytic	AA
L807	VP-XF1R2K0000Y	X	Peaking, 1.2μH	AB	C710	VCFYFA1HA104J+	X	0.1 50V	AB
L1861	VP-XF8R2K0000Y	X	Peaking, 8.2μH	AB	C711	VCKYPA1HB681K+X	X	680p 50V Ceramic	AA
L1862	VP-XF8R2K0000Y	X	Peaking, 8.2μH	AB	C718	VCKYPA2HB472K+X	X	4700p 500V Ceramic	AB
TRANSFORMERS									
△ T602	RTRNFA095WJZZ	X	Transformer	AR	C743	VCKYPH3DB561K	X	560p 2000V Ceramic	AB
△ T603	RTRNZA058WJZZ	X	Transformer	AB	C750	VCKYPA2HB102K+X	X	1000p 500V Ceramic	AB
△ T701	RTRNWA137WJZZ	X	Transformer		C751	RC-KZ0106GEZZ	X	3300p 250V Ceramic	AB
CAPACITORS									
C201	VCEA0A1CW476M+X	47	16V Electrolytic	AB	C752	VCKYPH3DB561K	X	560p 2KV Ceramic	AB
C202	VCEA0A0JW108M+X	1000	6.3V Electrolytic	AB	C753	RC-EZ0724CEZZ	X	100 160V Electrolytic	AC
C203	VCKYCY1HF103ZY	X	0.01 50V Ceramic	AA	C754	RC-EZ0638CEZZ	X	33 160V Electrolytic	AC
C205	VCKYCY1HF103ZY	X	0.01 50V Ceramic	AA	C755	VCQYTA1HM103J+	X	0.01 50V Mylar	AB
C206	VCEA0A1HW106M+X	10	50V Electrolytic	AB	C756	VCEA0A1EW228M+X	X	2200 25V Electrolytic	
C207	VCKYCY1HF103ZY	X	0.01 50V Ceramic	AA	C784	RC-KZ0341CEZZ	X	1000p 25V	
C208	VCKYCY1HF103ZY	X	0.01 50V Ceramic	AA	C801	VCFYFA1HA105J+	X	1 50V Mylar	AB
C209	VCKYCY1HF103ZY	X	0.01 50V Ceramic	AA	C802	VCKYCY1HF103ZY	X	0.01 50V Ceramic	AA
C210	VCKYCY1HF103ZY	X	0.01 50V Ceramic	AA	C803	VCEA9M1CW476M+X	47	16V Electrolytic	AA
C213	VCKYCY1HB102KY	X	1000p 50V Ceramic	AA	C804	VCKYCY1HF103ZY	X	0.01 50V Ceramic	AA
C301	VCEA0A1CW477M+X	470	16V Electrolytic	AB	C805	VCEA0A1HW105M+X	1	50V Electrolytic	AB
C304	VCEA0A1CW106M+X	10	16V Electrolytic	AA	C806	VCKYCY1HF103ZY	X	0.01 50V Ceramic	AA
C308	VCKYCY1HB822KY	X	8200p 50V Ceramic	AA	C807	VCEA0A1CW337M+X	330	16V Electrolytic	AB
C310	VCEA0A1HW105M+X	1	50V Electrolytic	AB	C808	VCKYCY1HF103ZY	X	0.01 50V Ceramic	AA
C311	VCEA0A1HW105M+X	1	50V Electrolytic	AB	C809	VCKYCY1HF103ZY	X	0.01 50V Ceramic	AA
C312	VCEA0A1HW224M+X	0.22	50V Electrolytic	AB	C810	VCKYCY1HF103ZY	X	0.01 50V Ceramic	AA
C313	VCKYCY1HB822KY	X	8200p 50V Ceramic	AA	C811	VCEA9M1CW106M+X	10	16V Electrolytic	AA
C317	VCE9GA1CW106M+X	10	16V Electrolytic, (N.P)	AB	C814	VCKYCY1HF103ZY	X	0.01 50V Ceramic	AA
C318	VCEA0A1CW107M+X	100	16V Electrolytic	AB	C815	VCKYCY1HF103ZY	X	0.01 50V Ceramic	AA
C321	VCEA0A1HW224M+X	0.22	50V Electrolytic	AB	C816	VCKYCY1EF104ZY	X	0.1 25V Ceramic	AA
C322	VCEA0A1HW105M+X	1	50V Electrolytic	AB	C817	VCEA9M1CW107M+X	100	16V Electrolytic	AB
C391	VCKYPA1HB102K+X	X	1000p 50V Ceramic	AA	C818	VCEA9M1HW475M+X	4.7	50V Electrolytic	
C392	VCQYTA1HM103J+	X	0.01 50V Mylar	AB	C819	VCCCCY1HH121JY	X	120p 50V Ceramic	AA
C393	VCEA0A1EW108M+X	1000	25V Electrolytic	AB	C820	VCEA9M1HW474M+X	0.47	50V Electrolytic	AA
C434	VCE9GA1CW106M+X	10	16V Electrolytic, (N.P)	AB	C821	VCKYCY1HF153ZY	X	0.015 50V Ceramic	AA
C435	VCE9GA1CW106M+X	10	16V Electrolytic, (N.P)	AB	C822	VCE9GA1HW105M+X	1	50V Electrolytic, (N.P)	AB
C436	VCKYCY1EF104ZY	X	0.1 25V Ceramic	AA	C823	VCKYCY1EF104ZY	X	0.1 25V Ceramic	AA
C437	VCE9GA1HW106M+X	10	50V Electrolytic, (N.P)	AB	C824	VCEA0A1CW337M+X	330	16V Electrolytic	AB
C438	VCEA0A1CW106M+X	10	16V Electrolytic	AA	C825	VCE9GA1HW105M+X	1	50V Electrolytic, (N.P)	AB
C439	VCKYCY1HF103ZY	X	0.01 50V Ceramic	AA	C826	VCKYCY1HF103ZY	X	0.01 50V Ceramic	AA
C452	VCE9GA1CW106M+X	10	16V Electrolytic, (N.P)	AB	C827	VCEA0A1CW476M+X	47	16V Electrolytic	AB
C505	VCEA0A1HW107M+X	100	50V Electrolytic	AB	C828	VCKYCY1HF103ZY	X	0.01 50V Ceramic	AA
C508	VCFYAA2A224J+	X	0.22 100V	AC	C829	VCEA9M1CW476M+X	47	16V Electrolytic	AA
C511	VCEA0A1VW477M+X	470	35V Electrolytic	AB	C831	VCKYCY1EF104ZY	X	0.1 25V Ceramic	AA
C512	VCKYPA2HB102K+X	X	1000p 500V Ceramic	AB	C833	VCKYCY1EF104ZY	X	0.1 25V Ceramic	AA
C513	RC-EZA332WJZZ+	X	Capacitor	AB	C834	VCEA0A1CW107M+X	100	16V Electrolytic	AB
C514	VCFYSA1JB273J+	X	0.027 63V	AB	C835	VCEA0A1CW106M+X	10	16V Electrolytic	AA
C515	VCEACA1HC335J+	X	3.3 50V Electrolytic	AB	C836	VCKYCY1HF103ZY	X	0.01 50V Ceramic	AA
C518	VCKYCY1HF103ZY	X	0.01 50V Ceramic	AA	C837	VCEA9M1HW105M+X	1	50V Electrolytic	AA
C601	VCQYTA1HM563J+	X	0.056 50V Mylar	AA	C839	VCCCCY1HH680JY	X	68p 50V Ceramic	AA
C602	VCEA0A1HW475M+X	4.7	50V Electrolytic	AB	C840	VCFYFA1HA105J+	X	1 50V	AB
C603	VCEA0A1HW105M+X	1	50V Electrolytic	AB	C841	VCCCCY1HH101JY	X	100p 50V Ceramic	AA
C604	VCEA0A2EW336M+X	33	250V Electrolytic	AB	C842	VCEA9M1HW474M+X	0.47	50V Electrolytic	AA
C606	VCKYPA2HB102K+X	X	1000p 500V Ceramic	AB	C843	VCEA0A1HW105M+X	1	50V Electrolytic	AB
△ C607	VCFPFD3ZA912H	X	9100p 1800V Metallized Polypro Film		C845	VCKYCY1CF224ZY	X	0.22 16V Ceramic	AA
C608	VCQYTA2AA103K+X	X	0.01 100V Mylar		C846	VCKYCY1HF103ZY	X	0.01 50V Ceramic	AA
C610	VCEA0A1EW227M+X	220	25V Electrolytic	AB	C847	VCCCCY1HH220JY	X	22p 50V Ceramic	AA
C611	VCFPVC2DB334J	X	0.33 200V Metallized Polypro Film	AB	C848	VCEA9M1HW105M+X	1	50V Electrolytic	AA
C642	VCEA0A1EW476M+X	47	25V Electrolytic	AB	C1001	VCEA0A1AW107M+X	100	10V Electrolytic	AA
C643	VCEA0A1AW477M+X	470	10V Electrolytic	AB	C1003	VCEA0A1CW106M+X	10	16V Electrolytic	AA
C650	VCKYPA2HB101K+X	X	100p 500V Ceramic	AB	C1004	VCKYCY1CF474ZY	X	0.47 16V Ceramic	AB
△ C701	RC-FZ029SCEZZ	X	Capacitor	AB	C1006	VCEA0A1HW225M+X	2.2	50V Electrolytic	AB
C702	RC-KZ0029CEZZ+	X	0.01 250V Ceramic	AB	C1007	VCEA0A1CW107M+X	100	16V Electrolytic	AB
C703	RC-KZ0029CEZZ+	X	0.01 250V Ceramic	AB	C1008	VCKYCY1HF103ZY	X	0.01 50V Ceramic	AA
C704	RC-KZ0029CEZZ	X	0.01 250V Ceramic	AB	C1009	VCKYCY1HF103ZY	X	0.01 50V Ceramic	AA
					C1011	VCKYCY1HB221KY	X	220p 50V Ceramic	AA
					C1012	VCEA0A1HW105M+X	1	50V Electrolytic	AB
					C1013	VCKYCY1HB102KY	X	1000p 50V Ceramic	AA
					C1014	VCE9GA1HW475M+X	4.7	50V Electrolytic, (N.P)	AB
					C1015	VCCCCY1HH101JY	X	100p 50V Ceramic	AA
					C1016	VCKYCY1EF104ZY	X	0.1 25V Ceramic	AA
					C1020	VCEA0A0JW477M+X	470	6.3V Electrolytic	AB
					C1081	VCQYTA1HM104J+	X	0.1 50V Mylar	AB

Ref. No.	Part No.	★	Description	Code	Ref. No.	Part No.	★	Description	Code
C1849	VCFYFA1HA223J+	X	0.022 50V	AA	R528	VRS-CY1JF683JY	X	68k 1/16W Metal Oxide	AA
C1855	VCKYCY1HB561KY X		560p 50V Ceramic	AA	R601	VRD-RM2HD820JY	X	82 1/2W Carbon	
C1856	VCKYCY1HB102KY X		1000p 50V Ceramic	AA	R602	VRD-RA2BE393JY	X	39k 1/8W Carbon	AA
C1861	VCCCCY1HH221JY X		220p 50V Ceramic	AA	R603	VRD-RA2BE273JY	X	27k 1/8W Carbon	AA
C1862	VCKYCY1HB102KY X		1000p 50V Ceramic	AA	R604	VRD-RA2BE473JY	X	47k 1/8W Carbon	AA
C1863	VCCCCY1HH221JY X		220p 50V Ceramic	AA	R605	VRD-RM2HD104JY	X	100k 1/2W Carbon	AA
C1864	VCKYCY1HB102KY X		1000p 50V Ceramic	AA	R607	VRD-RM2HD121JY	X	120 1/2W Carbon	
C1868	VCEA9M1CW336M+X	33	16V Electrolytic		△ R608	VRD-RM2HD102JY	X	1k 1/2W Carbon	AA
RESISTORS					R609	VRD-RM2HD270JY	X	27 1/2W Carbon	AA
RJ1	VRS-CY1JF000JY	X	0 1/16W Metal Oxide	AA	△ R611	VRN-RL3AB1R0J+	X	1 1W Metal Film	AB
RJ3	VRS-CY1JF000JY	X	0 1/16W Metal Oxide	AA	△ R612	VRD-RM2HD270JY	X	27 1/2W Carbon	AA
RJ5	VRS-CY1JF000JY	X	0 1/16W Metal Oxide	AA	R613	VRS-CY1JF000JY	X	0 1/16W Metal Oxide	AA
RJ9	VRS-CY1JF000JY	X	0 1/16W Metal Oxide	AA	R614	VRD-RA2BE154JY	X	150k 1/8W Carbon	AA
RJ10	VRS-CY1JF000JY	X	0 1/16W Metal Oxide	AA	R615	VRD-RA2BE102JY	X	1k 1/8W Carbon	AA
RJ12	VRS-CY1JF000JY	X	0 1/16W Metal Oxide	AA	R616	VRD-RA2BE102JY	X	1k 1/8W Carbon	AA
RJ13	VRS-CY1JF000JY	X	0 1/16W Metal Oxide	AA	R617	VRS-CY1JF123JY	X	12k 1/16W Metal Oxide	AA
RJ14	VRS-CY1JF000JY	X	0 1/16W Metal Oxide	AA	R618	VRS-CY1JF103JY	X	10k 1/16W Metal Oxide	AA
RJ17	VRS-CY1JF000JY	X	0 1/16W Metal Oxide	AA	R621	VRN-RL2HC4R7J+	X	4.7 1/2W Metal Film	AB
RJ18	VRS-CY1JF000JY	X	0 1/16W Metal Oxide	AA	R622	VRS-VV3DB682J	X	6.8k 2W Metal Oxide	AA
RJ19	VRS-CY1JF000JY	X	0 1/16W Metal Oxide	AA	R631	VRS-KT3LB391J	X	390 3W Metal Oxide	AB
RJ20	VRS-CY1JF000JY	X	0 1/16W Metal Oxide	AA	R637	VRD-RA2BE331JY	X	330 1/8W Carbon	AA
RJ22	VRS-CY1JF000JY	X	0 1/16W Metal Oxide	AA	R638	VRD-RA2BE181JY	X	180 1/8W Carbon	AA
RJ25	VRS-CY1JF000JY	X	0 1/16W Metal Oxide	AA	R639	VRD-RM2HD271JY	X	270 1/2W Carbon	
RJ26	VRS-CY1JF000JY	X	0 1/16W Metal Oxide	AA	R642	VRN-RL3DB2R2J+	X	2.2 2W Metal Film	
RJ29	VRS-CY1JF000JY	X	0 1/16W Metal Oxide	AA	R661	VRD-RA2BE102JY	X	1k 1/8W Carbon	AA
RJ30	VRS-CY1JF000JY	X	0 1/16W Metal Oxide	AA	R662	VRS-CY1JF103JY	X	10k 1/16W Metal Oxide	AA
RJ101	VRS-CY1JF000JY	X	0 1/16W Metal Oxide	AA	R701	VRW-KQ3NC1R5K	X	1.5 7W Cement	AB
R201	VRS-CY1JF101JY	X	100 1/16W Metal Oxide	AA	R702	VRD-RM2HD154JY	X	150k 1/2W Carbon	AA
R202	VRS-CY1JF101JY	X	100 1/16W Metal Oxide	AA	R704	VRD-RA2BE101JY	X	100 1/8W Carbon	AA
R205	VRS-CY1JF680JY	X	68 1/16W Metal Oxide	AA	△ R705	VRN-RL3DBR47J+	X	0.47 2W Metal Film	
R206	VRS-CY1JF122JY	X	1.2k 1/16W Metal Oxide	AA	△ R706	VRN-RL3DBR39J+	X	0.39 2W Metal Film	
R207	VRS-CY1JF221JY	X	220 1/16W Metal Oxide	AA	R710	VRD-RM2HD220JY	X	22 1/2W Carbon	AA
R208	VRS-CY1JF331JY	X	330 1/16W Metal Oxide	AA	R711	VRD-RA2EE122JY	X	1.2k 1/4W Carbon	AA
R209	VRS-CY1JF392JY	X	3.9k 1/16W Metal Oxide	AA	R712	VRD-RA2BE102JY	X	1k 1/8W Carbon	AA
R216	VRS-RG3LB333J+	X	33k 3W Metal Oxide	AB	R713	VRD-RA2BE102JY	X	1k 1/8W Carbon	AA
R220	VRS-CY1JF221JY	X	220 1/16W Metal Oxide	AA	R725	VRD-RM2HD821JY	X	820 1/2W Carbon	AA
R301	VRS-CY1JF102JY	X	1k 1/16W Metal Oxide	AA	R726	VRN-RL2HCR47J+	X	0.47 1/2W Metal Film	AB
R302	VRN-RL3DBR10J+	X	0.1 2W Metal Film		R753	VRD-RM2HD124JY	X	120k 1/2W Carbon	AA
R303	VRS-CY1JF473JY	X	47k 1/16W Metal Oxide	AA	R754	VRN-RL3AB8R2J+	X	8.2 1W Metal Film	AB
R304	VRD-RA2BE683JY	X	68k 1/8W Carbon	AA	R756	VRS-RG3DB121J+	X	120 2W Metal Oxide	AB
R305	VRS-CY1JF274JY	X	270k 1/16W Metal Oxide	AA	R801	VRS-CY1JF561JY	X	560 1/16W Metal Oxide	AA
R307	VRS-CY1JF222JY	X	2.2k 1/16W Metal Oxide	AA	R802	VRS-CY1JF682JY	X	6.8k 1/16W Metal Oxide	AA
R308	VRS-CY1JF222JY	X	8.2k 1/16W Metal Oxide	AA	R803	VRS-CY1JF103JY	X	10k 1/16W Metal Oxide	AA
R311	VRD-RA2BE103JY	X	10k 1/8W Carbon	AA	R804	VRS-CY1JF222JY	X	2.2k 1/16W Metal Oxide	AA
R314	VRS-CY1JF822JY	X	8.2k 1/16W Metal Oxide	AA	R805	VRS-CY1JF222JY	X	2.2k 1/16W Metal Oxide	AA
R315	VRS-CY1JF222JY	X	2.2k 1/16W Metal Oxide	AA	R806	VRS-CY1JF222JY	X	2.2k 1/16W Metal Oxide	AA
R362	VRS-CY1JF332JY	X	3.3k 1/16W Metal Oxide	AA	R807	VRS-CY1JF222JY	X	2.2k 1/16W Metal Oxide	AA
R363	VRS-CY1JF564JY	X	560k 1/16W Metal Oxide	AA	R808	VRD-RA2BE273JY	X	27k 1/8W Carbon	AA
R365	VRS-CY1JF564JY	X	560k 1/16W Metal Oxide	AA	R812	VRS-CY1JF101JY	X	100 1/16W Metal Oxide	AA
R366	VRS-CY1JF332JY	X	3.3k 1/16W Metal Oxide	AA	R814	VRS-CY1JF473JY	X	47k 1/16W Metal Oxide	AA
R381	VRS-CY1JF564JY	X	560k 1/16W Metal Oxide	AA	R815	VRS-CY1JF473JY	X	47k 1/16W Metal Oxide	AA
R382	VRS-CY1JF332JY	X	3.3k 1/16W Metal Oxide	AA	R816	VRS-CY1JF223JY	X	22k 1/16W Metal Oxide	AA
R383	VRS-CY1JF564JY	X	560k 1/16W Metal Oxide	AA	R817	VRS-CY1JF473JY	X	47k 1/16W Metal Oxide	AA
R384	VRS-CY1JF332JY	X	3.3k 1/16W Metal Oxide	AA	R818	VRD-RS2BE102JY	X	1K 1/8W Carbon	AA
R431	VRS-CY1JF101JY	X	100 1/16W Metal Oxide	AA	R823	VRD-RA2BE101JY	X	100 1/8W Carbon	AA
R432	VRS-CY1JF750JY	X	75 1/16W Metal Oxide	AA	R824	VRD-RA2BE101JY	X	100 1/8W Carbon	AA
R433	VRS-CY1JF750JY	X	75 1/16W Metal Oxide	AA	R826	VRD-RA2BE101JY	X	100 1/8W Carbon	AA
R434	VRS-CY1JF750JY	X	75 1/16W Metal Oxide	AA	R827	VRS-CY1JF102JY	X	1k 1/16W Metal Oxide	AA
R435	VRS-CY1JF750JY	X	75 1/16W Metal Oxide	AA	R828	VRS-CY1JF471JY	X	470 1/16W Metal Oxide	AA
R436	VRD-RA2BE101JY	X	100 1/8W Carbon	AA	R829	VRD-RA2BE472JY	X	4.7k 1/8W Carbon	AA
R437	VRS-CY1JF101JY	X	100 1/16W Metal Oxide	AA	R830	VRS-CY1JF393JY	X	39k 1/16W Metal Oxide	AA
R438	VRS-CY1JF000JY	X	0 1/16W Metal Oxide	AA	R831	VRS-CY1JF271JY	X	270 1/16W Metal Oxide	AA
R461	VRS-CY1JF750JY	X	75 1/16W Metal Oxide	AA	R832	VRS-CY1JF822JY	X	8.2k 1/16W Metal Oxide	AA
R462	VRS-CY1JF101JY	X	100 1/16W Metal Oxide	AA	R833	VRS-CY1JF221JY	X	220 1/16W Metal Oxide	AA
R502	VRS-RG3AB102J+	X	1k 1W Metal Oxide	AB	R835	VRS-CY1JF332JY	X	3.3k 1/16W Metal Oxide	AA
R503	VRN-RL3DB1R2J+	X	1.2 2W Metal Film	AB	R836	VRD-RA2BE470JY	X	47 1/8W Carbon	AA
R504	VRS-CY1JF222JY	X	2.2k 1/16W Metal Oxide	AA	R838	VRD-RA2BE105JY	X	1M 1/8W Carbon	AA
R506	VRS-RG3AB331J+	X	330 1W Metal Oxide	AB	R839	VRS-CY1JF101JY	X	100 1/16W Metal Oxide	AA
R507	VRD-RM2HD1R0JY	X	1 1/2W Carbon	AA	R840	VRS-CY1JF124JY	X	120k 1/16W Metal Oxide	AA
R513	VRD-RM2HD333JY	X	33k 1/2W Carbon	AA	R841	VRD-RA2BE821JY	X	820 1/8W Carbon	AA
R514	VRD-RM2HD682JY	X	6.8k 1/2W Carbon	AA	R842	VRS-CY1JF471JY	X	470 1/16W Metal Oxide	AA
R520	VRS-CY1JF123JY	X	12k 1/16W Metal Oxide	AA	R843	VRS-CY1JF103JY	X	10k 1/16W Metal Oxide	AA
R524	VRD-RA2BE103JY	X	10k 1/8W Carbon	AA	R847	VRS-CY1JF475JY	X	4.7M 1/16W Metal Oxide	AA
R525	VRD-RA2BE122JY	X	1.2k 1/8W Carbon	AA	R1002	VRS-CY1JF183JY	X	18k 1/16W Metal Oxide	AA
R526	VRD-RA2BE101JY	X	100 1/8W Carbon	AA	R1003	VRS-CY1JF822JY	X	8.2k 1/16W Metal Oxide	AA
					R1006	VRS-CY1JF822JY	X	8.2k 1/16W Metal Oxide	AA

Ref. No.	Part No.	*	Description	Code	Ref. No.	Part No.	*	Description	Code
DUNTKC574WEA0 PWB-C MTS UNIT									
PWB-C MTS UNIT INTEGRATED CIRCUIT									
IC3001	VHICXA2194Q-1Y	X	CXA2194Q	AP	R3016	VRS-CY1JF102JY	X	1k 1/16W Metal Oxide	AA
TRANSISTORS					R3018	VRS-CY1JF102JY	X	1k 1/16W Metal Oxide	AA
Q3001	VS2SD601AR/-1Y	X	2SD601AR	AB	R3019	VRS-CY1JF102JY	X	1k 1/16W Metal Oxide	AA
Q3002	VS2SD601AR/-1Y	X	2SD601AR	AB	R3021	VRS-CY1JF102JY	X	1k 1/16W Metal Oxide	AA
Q3004	VS2SD601AR/-1Y	X	2SD601AR	AB	R3025	VRS-CY1JF272JY	X	2.7k 1/16W Metal Oxide	AA
Q3005	VS2SD601AR/-1Y	X	2SD601AR	AB	R3026	VRS-CY1JF331JY	X	330 1/16W Metal Oxide	AA
Q3006	VS2SD601AR/-1Y	X	2SD601AR	AB	R3027	VRS-CY1JF392JY	X	3.9k 1/16W Metal Oxide	AA
Q3007	VS2SD601AR/-1Y	X	2SD601AR	AB	R3028	VRS-CY1JF683JY	X	68k 1/16W Metal Oxide	AA
CAPACITORS					R3029	VRS-CY1JF392JY	X	3.9k 1/16W Metal Oxide	AA
C3001	VCE9GA1HW475M+X	4.7	50V Electrolytic, (N.P)	AB	R3030	VRS-CY1JF683JY	X	68k 1/16W Metal Oxide	AA
C3002	VCKYCY1HB562KY	X	5600p 50V Ceramic	AA	R3031	VRS-CY1JF182JY	X	1.8k 1/16W Metal Oxide	AA
C3003	VCQYTA1HM123K+X	0.012	50V Mylar	AB	R3032	VRS-CY1JF223JY	X	22k 1/16W Metal Oxide	AA
C3004	VCEA0A1HW105M+X	1	50V Electrolytic	AB	R3033	VRS-CY1JF102JY	X	1k 1/16W Metal Oxide	AA
C3005	VCEA0A1HW475M+X	4.7	50V Electrolytic	AB	R3034	VRS-CY1JF182JY	X	1.8k 1/16W Metal Oxide	AA
C3006	VCEA0A1CW106M+X	10	16V Electrolytic	AA	R3035	VRS-CY1JF223JY	X	22k 1/16W Metal Oxide	AA
C3007	VCEA0A1HW475M+X	4.7	50V Electrolytic	AB	R3036	VRS-CY1JF102JY	X	1k 1/16W Metal Oxide	AA
C3008	VCKYCY1HF103ZY	X	0.01 50V Ceramic	AA	R3082	VRS-CY1JF103JY	X	10k 1/16W Metal Oxide	AA
C3009	VCEA0A1CW227M+X	220	16V Electrolytic	AB	R3083	VRS-CY1JF103JY	X	10k 1/16W Metal Oxide	AA
C3010	VCE9GA1HW475M+X	4.7	50V Electrolytic, (N.P)	AB	R3084	VRS-CY1JF103JY	X	10k 1/16W Metal Oxide	AA
C3011	VCEA0A1HW475M+X	4.7	50V Electrolytic	AB	R3085	VRS-CY1JF103JY	X	10k 1/16W Metal Oxide	AA
C3012	VCE9GA1HW475M+X	4.7	50V Electrolytic, (N.P)	AB	MISCELLANEOUS PARTS				
C3013	VCKYCY1HB272KY	X	2700p 50V Ceramic	AA	P3007	QPLGZ0610CEZZ	X	Plug, 6Pin	AB
C3014	VCQYTA1HM473K+X	0.047	50V Mylar	AB	P3008	QPLGZ0610CEZZ	X	Plug, 6Pin	AB
C3015	VCEACA1HC335K+X	3.3	50V Electrolytic	AB	P3009	QPLGZ0810CEZZ	X	Plug, 8Pin	AB
C3016	VCE9GA1HW475M+X	4.7	50V Electrolytic, (N.P)	AB					
C3017	VCEACA1CC106K+X	10	16V Electrolytic	AB					
C3018	VCEA0A1HW105M+X	1	50V Electrolytic	AB					
C3019	VCEA0A1CW106M+X	10	16V Electrolytic	AA					
C3020	VCEA0A1CW106M+X	10	16V Electrolytic	AA					
C3021	VCEA0A1CW106M+X	10	16V Electrolytic	AA					
C3022	VCEA0A1CW106M+X	10	16V Electrolytic	AA					
C3023	VCKYCY1HF103ZY	X	0.01 50V Ceramic	AA					
C3024	VCKYCY1HF103ZY	X	0.01 50V Ceramic	AA					
C3025	VCKYCY1HF473ZY	X	0.047 50V Ceramic	AB					
C3026	VCKYCY1HF473ZY	X	0.047 50V Ceramic	AB					
C3030	VCQYTA1HM682K+X	6800p	50V Mylar	AA					
C3031	VCKYCY1HF682ZY	X	6800p 50V Ceramic	AA					
C3034	VCEA0A1HW224M+X	0.22	50V Electrolytic	AB					
C3037	VCEA0A1HW335M+X	3.3	50V Electrolytic	AA					
C3038	VCEA0A1HW335M+X	3.3	50V Electrolytic	AA					
C3039	VCEA0A1HW224M+X	0.22	50V Electrolytic	AB					
C3042	VCKYCY1HB681KY	X	680p 50V Ceramic	AA					
C3043	VCKYCY1HB681KY	X	680p 50V Ceramic	AA					
C3044	VCEA0A1EW476M+X	47	25V Electrolytic	AB					
C3045	VCEA0A1HW335M+X	3.3	50V Electrolytic	AA					
C3046	VCEA0A1HW335M+X	3.3	50V Electrolytic	AA					
C3047	VCEA0A1HW335M+X	3.3	50V Electrolytic	AA					
C3048	VCEA0A1HW335M+X	3.3	50V Electrolytic	AA					
RESISTORS									
R3001	VRS-CY1JF221JY	X	220 1/16W Metal Oxide	AA					
R3002	VRS-CY1JF221JY	X	220 1/16W Metal Oxide	AA					
R3003	VRS-CY1JF105JY	X	1M 1/16W Metal Oxide	AA					
R3004	VRS-CY1JF104JY	X	100k 1/16W Metal Oxide	AA					
R3005	VRS-CY1JF623JY	X	62k 1/16W Metal Oxide	AA					
R3006	VRS-CY1JF101JY	X	100 1/16W Metal Oxide	AA					
R3007	VRS-CY1JF332JY	X	3.3k 1/16W Metal Oxide	AA					
R3008	VRS-CY1JF302JY	X	3k 1/16W Metal Oxide	AA					
R3009	VRS-CY1JF101JY	X	100 1/16W Metal Oxide	AA					
R3010	VRS-CY1JF392JY	X	3.9k 1/16W Metal Oxide	AA					
R3011	VRS-CY1JF102JY	X	1k 1/16W Metal Oxide	AA					
R3012	VRS-CY1JF102JY	X	1k 1/16W Metal Oxide	AA					
R3013	VRS-CY1JF102JY	X	1k 1/16W Metal Oxide	AA					
R3014	VRS-CY1JF102JY	X	1k 1/16W Metal Oxide	AA					

Ref. No. Part No. ★ Description Code

MISCELLANEOUS PARTS

△ ACC701	QACCZA020WJPZ	X	AC Cord	AC
SP301	VSP1205PB09WA	X	Speaker	AK
	LHLDK0014PEZZ	X	AC Cord Holder	AB
	LHLDZA096WJZZ	X	Holder	AB
	LHLDZA107WJZZ	X	Holder	AB
	TCAUH3045GJZZ	X	Caution Card	AB
	QCNW-A871WJZZ	X	Connecting Cord	AB
	QCNW-A872WJZZ	X	Connecting Cord	AC
	QCNW-A873WJZZ	X	Connecting Cord	AC
	QPLGA0017CEZZ	X	Plug	AC

SUPPLIED ACCESSORIES

ACCESSORIES

RRMCGA108WJSA	X	Infrared R-C	AT
TiNS-B246WJZZ	X	Operation Manual	

**PACKING PARTS
(NOT REPLACEMENT ITEM)**

SPAKCB318WJZZ	-	Packing Case	—
SPAKPA055WJZZ	-	Wrapping Paper	—
SPAKXA145WJZZ	-	Buffer Material	—
SSAKA0101GJZZ	-	Polyethylene Bag	—
TLABM0005GJZZ	-	Model Label	—
TLABZA713WJZZ	-	Label	—

CABINET PARTS

1	CCABAA596WEH0	X	Front Cabinet Ass'y	—
1-1	Not Avairable	-	Front Cabinet	AD
1-2	HBDGB3155CESA	X	SHARP Badge	
1-3	HDECQA403WJSA	X	LED, R/C Cover	
1-4	JBTN-A070WJKD	X	Power Button	
1-5	MSPRC0005PEFW	X	Power Button Spring	AA
1-6	GDORFA015WJKD	X	Door	
1-7	MSPRPA012WJFW	X	Door Spring	AB
1-8	HiNDPA194WJSA	X	Indication Plate	AC
1-9	GBFL-A007WJZZ	X	Speaker Baffer	AC
2	GCABBA088WJKA	X	Rear Cabinet	AX

Ref. No. Part No. ★ Description Code

CABINET PARTS LOCATION

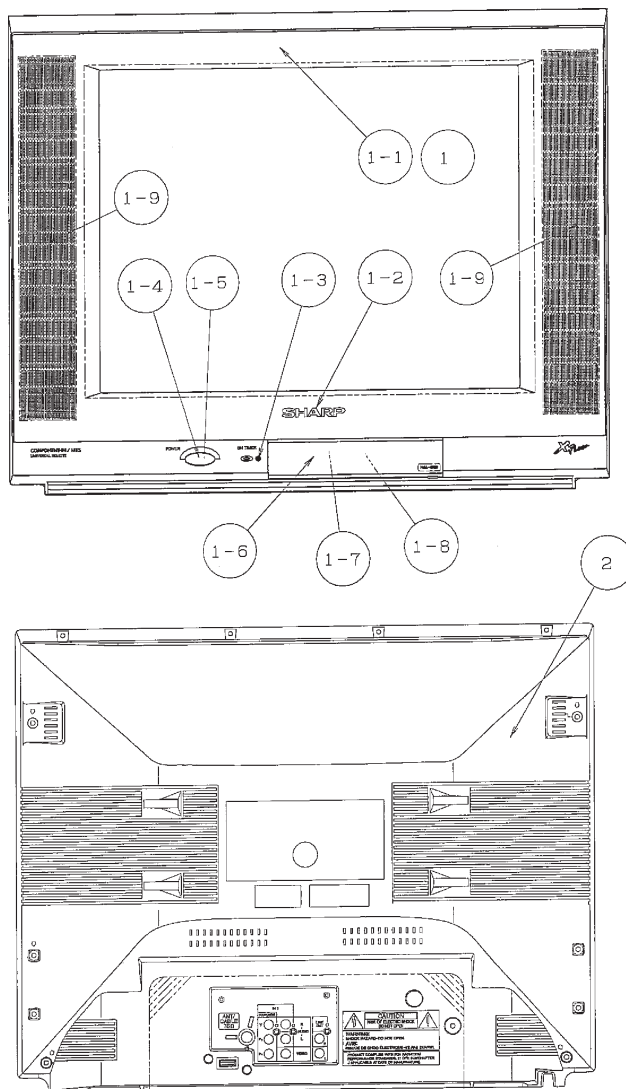

PACKING OF THE SET

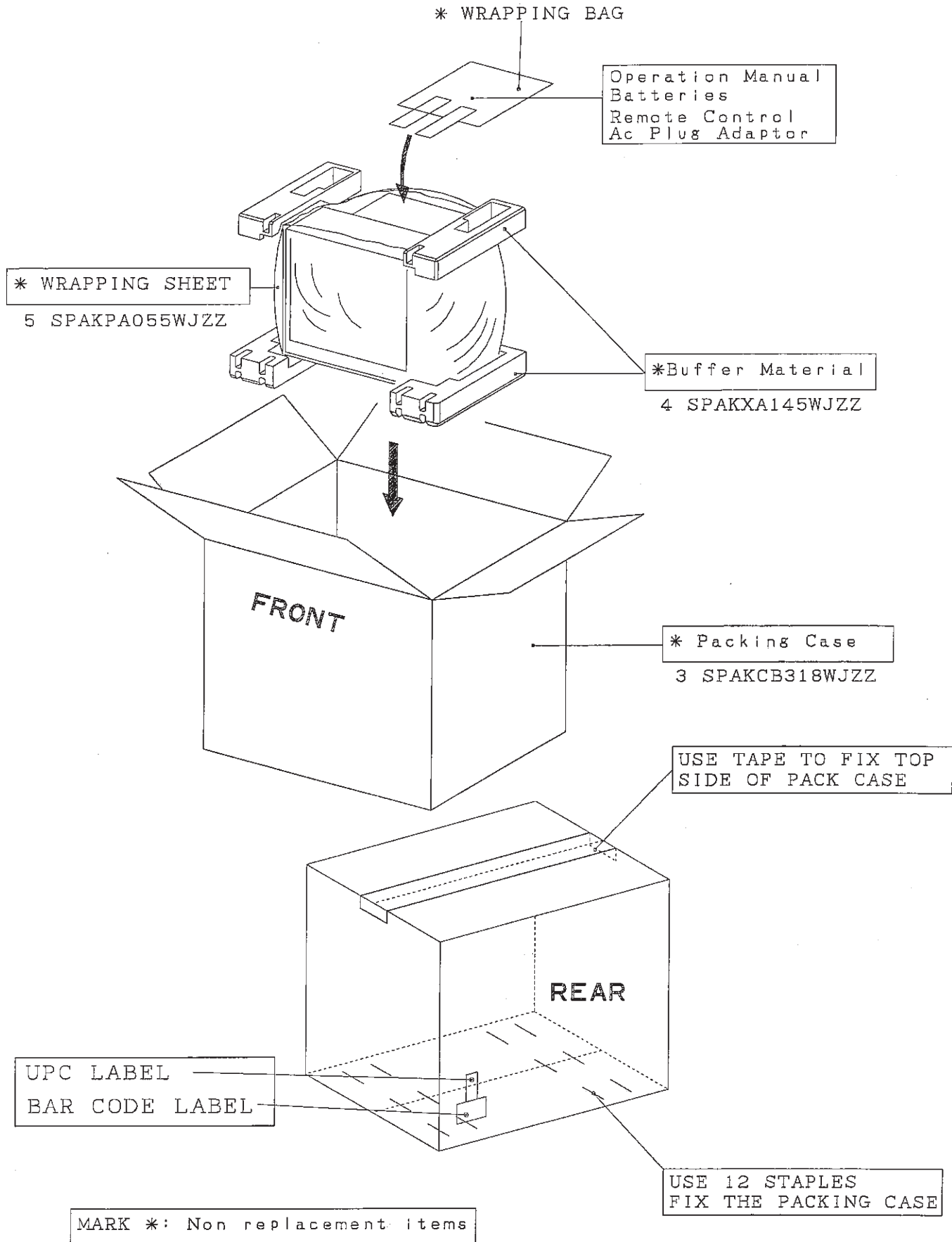

SHARP

COPYRIGHT © 2004 BY SHARP CORPORATION

ALL RIGHTS RESERVED.

No part of this publication may be reproduced, stored in a retrieval system, or transmitted in any form or by any means, electronic, mechanical, photocopying, recording, or otherwise, without prior written permission of the publisher.

TQ1756-S
Jun 2004 Printed in Japan
In Japan gedruckt

Design and Production Information	
Design	: SEM
Production	: SEMEX

MY.DS

SHARP CORPORATION
AV Systems Group
Quality & Reliability Control Center
Yaita, Tochigi 329-2193, Japan