

SERVICE MANUAL

BA - 3 CHASSIS

<u>MODEL</u>	<u>COMMANDER</u>	<u>DEST.</u>	<u>CHASSIS NO.</u>	<u>MODEL</u>	<u>COMMANDER</u>	<u>DEST.</u>	<u>CHASSIS NO.</u>
KV-20M20	RM-Y116	CND	SCC-J93B-A	KV-21R20	RM-Y116	E	SCC-J94B-A
KV-20M20	RM-Y116	US	SCC-J84B-A	KV-21RS20	RM-Y116	E	SCC-J94C-A
KV-20S20	RM-Y116	CND	SCC-J93C-A	KV-21RD1	RM-Y116	MEX	SCC-J95C-A
KV-20S20	RM-Y116	US	SCC-J84F-A	KV-21PM1	RM-Y116	MEX	SCC-J95D-A
KV-20S21	RM-Y116	US	SCC-J84G-A	KV-21SD1	RM-Y116	MEX	SCC-J95E-A
KV-20S30	RM-Y116	CND	SCC-J93D-A	KV-21PS1	RM-Y116	MEX	SCC-J95F-A
KV-20S30	RM-Y116	US	SCC-J84C-A				

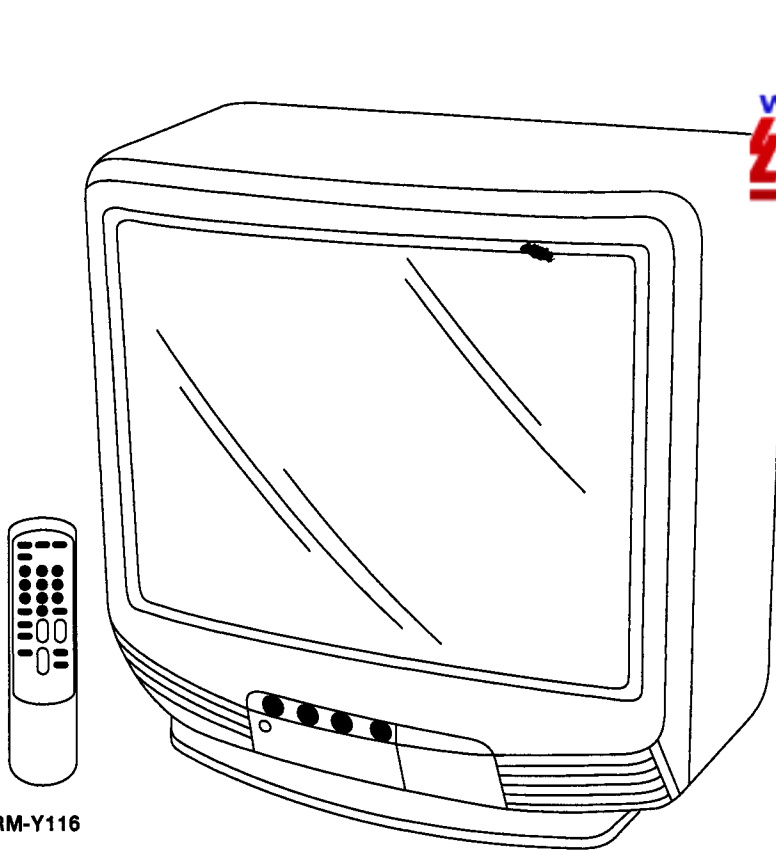

RM-Y116

KV-20M20



TRINITRON® COLOR TV
SONY®

※ Please file according to model size.

SPECIFICATIONS

For all models

Television system	American TV standards
Channel coverage	VHF: 2-13 UHF: 14-69 CATV: 1-125
Picture tube	Trinitron® tube 20-inch picture measured diagonally 21-inch picture measured diagonally
Antenna	75Ω external antenna terminal for VHF / UHF, F-Terminal
Speaker size	Full range 3 1/2 x 2 inches (90 x 50 mm)
Power requirements	120V AC, 60Hz
Dimensions (W/H/D)	20 1/2 x 18 3/4 x 18 1/2 inches (522 x 477 x 471.7 mm)
Supplied accessories	Remote Commander RM-Y116 (1) with 2 AA size (R6) battery Dipole antenna (1) Antenna connector (1)

■ KV-20M20/21R20/21RD1/21PM1

Input	VIDEO (phono jacks): 1V _{p-p} , 75Ω unbalanced negative sync Audio (phono jacks): 500 mV _{rms} (100% modulation) Impedance: 47Ω A/V input (Rear)
Output	Earphone jack
Speaker output	1 speaker 2W(8Ω)
Power consumption	90W when in use 6W in standby
Weight	46 lbs 13 Oz (21.3 Kg)

Design and specifications are subject to change without notice.
SONY CORPORATION Printed in U.S.A.

■ KV-20S21/20S20/21RS20/21SD1/21PS1/20S30

Input	VIDEO (phono jacks): 1V _{p-p} , 75Ω unbalanced negative sync Audio (phono jacks): 500 mV _{rms} (100% modulation) Impedance: 47Ω A/V input (Rear) Front A/V input (KV-20S30 only)
Output	Headphone jack Audio Out (KV-20S30 only) More than 800 mV _{rms} at the maximum volume setting (Variable) More than 800 mV _{rms} (Fix) Impedance: 5KΩ
Speaker Output	2 speaker (2W x 2) 8Ω
Power consumption	90W when in use 7W in standby
Weight	47 lbs.(21.4 Kg)

SAFETY CHECK-OUT (US model only)

After correcting the original service problem, perform the following safety checks before releasing the set to the customer:

1. Check the area of your repair for unsoldered or poorly-soldered connections. Check the entire board surface for solder splashes and bridges.
2. Check the interboard wiring to ensure that no wires are "pinched" or contact high-wattage resistors.
3. Check that all control knobs, shields, covers, ground straps, and mounting hardware have been replaced. Be absolutely certain that you have replaced all the insulators.
4. Look for unauthorized replacement parts, particularly transistors, that were installed during a previous repair. Point them out to the customer and recommend their replacement.
5. Look for parts which, through functioning, show obvious signs of deterioration. Point them out to the customer and recommend their replacement.
6. Check the line cords for cracks and abrasion. Recommend the replacement of any such line cord to the customer.
7. Check the condition of the monopole antenna (if any). Make sure the end is not broken off, and has the plastic cap on it. Point out the danger of impalement on a broken antenna to the customer, and recommend the antenna's replacement.
8. Check the B+ and HV to see they are at the values specified. Make sure your instruments are accurate; be suspicious of your HV meter if sets always have low HV.
9. Check the antenna terminals, metal trim, "metallized" knobs, screws, and all other exposed metal parts for AC leakage. Check leakage as described below.

LEAKAGE TEST

The AC leakage from any exposed metal part to earth ground and from all exposed metal parts to any exposed metal part having a return to chassis, must not exceed 0.5mA (500 microamperes). Leakage current can be measured by any one of three methods.

1. A commercial leakage tester, such as the Simpson 229 or RCA WT-540A. Follow the manufacturers' instructions to use these instruments.
2. A battery-operated AC milliampmeter. The Data Precision 245 digital multimeter is suitable for this job.
3. Measuring the voltage drop across a resistor by means of a VOM or battery-operated AC voltmeter. The "limit" indication is 0.75V, so analog meters must have an accurate low-voltage scale. The Simpson 250 and Sanwa SH-63Trd are examples of a passive VOM that is suitable. Nearly all battery operated digital multimeters that have a 2V AC range are suitable. (See Fig. A)

HOW TO FIND A GOOD EARTH GROUND

A cold-water pipe is guaranteed earth ground; the cover-plate retaining screw on most AC outlet boxes is also at earth ground. If the retaining screw is to be used as your earth-ground, verify that it is at ground by measuring the resistance between it and a cold-water pipe with an ohmmeter. The reading should be zero ohms. If a cold-water pipe is not accessible, connect a 60-100 watts trouble light (not a neon lamp) between the hot side of the receptacle and the retaining screw. Try both slots, if necessary, to locate the hot side of the line, the lamp should light at normal brilliance if the screw is at ground potential. (See Fig. B)

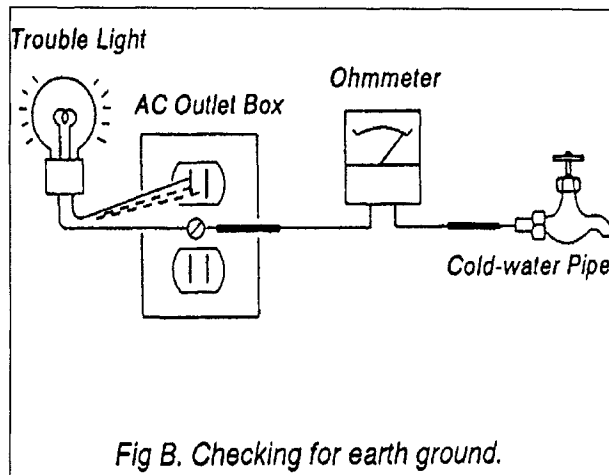
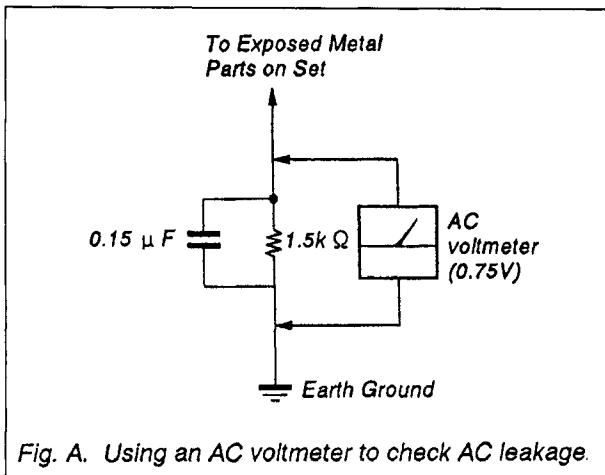

TABLE OF CONTENTS

<u>Section</u>	<u>Title</u>	<u>Page</u>	<u>Section</u>	<u>Title</u>	<u>Page</u>
1. GENERAL			4. SAFETY RELATED ADJUSTMENT		17
	Connecting the TV	.5	5. CIRCUIT ADJUSTMENTS		
	Using the Remote Control	.6	5-1. Electrical Adjustment by Remote Commander		.19
	Setting Up Channels	.6	5-2. A Board Adjustments		.21
	Watching the TV	.7	6. DIAGRAMS		
	Using the Video Menu	.8	6-1. Block Diagrams		.23
	Additional Features	.9	6-2. Circuit Boards Location		.27
	Selecting Stereo or Bilingual Programs (MTS)		6-3. Printed Wiring Boards and Schematic Diagrams		.28
	Selection Caption Vision		• A Board		.28
	Customizing the Channel Number Buttons		• C Board		.36
	Listening with Headphones		6-4. Semiconductors		.36
2. DISASSEMBLY			7. EXPLODED VIEWS		
2-1. Rear Cover Removal		.11	7-1. Chassis		.37
2-2. A Board Removal		.11	8. ELECTRICAL PARTS LIST		.38
2-3. Service Position		.11			
2-4. Picture Tube Removal		.12			
3. SET-UP ADJUSTMENTS					
3-1. Beam Landing		.13			
3-2. Convergence		.14			
3-3. Focus		.16			
3-4. Screen (G2)		.16			
3-5. Method of Setting the Service Adjustment Mode		.16			
3-6. White Balance Adjustment		.16			

(CAUTION)

SHORT CIRCUIT THE ANODE OF THE PICTURE TUBE AND THE ANODE CAP TO THE METAL CHASSIS, CRT SHIELD, OR CARBON PAINTED ON THE CRT, AFTER REMOVING THE ANODE.

WARNING!!

AN ISOLATION TRANSFORMER SHOULD BE USED DURING ANY SERVICE TO AVOID POSSIBLE SHOCK HAZARD, BECAUSE OF LIVE CHASSIS.
THE CHASSIS OF THIS RECEIVER IS DIRECTLY CONNECTED TO THE AC POWER LINE.

SAFETY-RELATED COMPONENT WARNING!!

COMPONENTS IDENTIFIED BY SHADING AND MARK Δ ON THE SCHEMATIC DIAGRAMS, EXPLODED VIEWS, AND IN THE PARTS LIST ARE CRITICAL TO SAFE OPERATION. REPLACE THESE COMPONENTS WITH SONY PARTS WHOSE PART NUMBERS APPEAR AS SHOWN IN THIS MANUAL OR IN SUPPLEMENTS PUBLISHED BY SONY. CIRCUIT ADJUSTMENTS THAT ARE CRITICAL TO SAFE OPERATION ARE IDENTIFIED IN THIS MANUAL. FOLLOW THESE PROCEDURES WHENEVER CRITICAL COMPONENTS ARE REPLACED OR IMPROPER OPERATION IS SUSPECTED.

SECTION 1 GENERAL

The operating instructions mentioned here are partial abstracts from the Operating Instruction Manual. The page numbers of the Operating Instructions remain as in the manual.

Step 1: Connecting the TV

You can use an indoor antenna, outdoor antenna, or cable system with your TV. Outdoor antennas or cable TV systems usually provide the best picture quality.

Connecting an Indoor, Outdoor or Cable Antenna

Connect your antenna or cable to the TV's VHF/UHF antenna terminal.

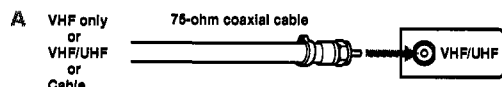

If you cannot connect your antenna or cable directly to the TV antenna terminal, follow one of the diagrams below.

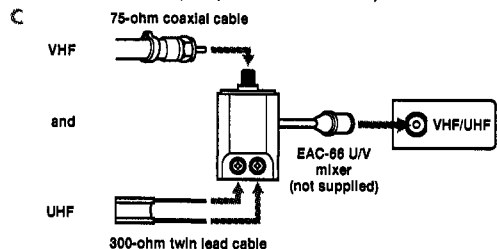
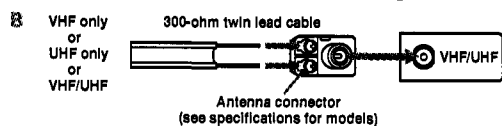

Connecting to a Cable TV System Through a Cable Box

If your cable system requires use of a cable box, make the connection as shown below.

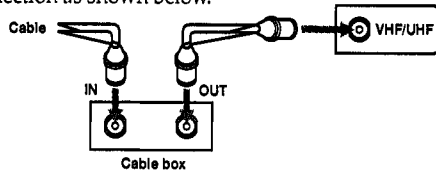

Connecting a VCR

See your VCR instructions to set up the VCR. After connecting the VCR to the TV, you will be able to do the following:

- Watch video tapes
- Record one TV program while viewing another

Check the model number of your TV and select the appropriate connection diagram.

Notes

- If your cable system requires use of a Cable Box, install it between the VCR and the TV.
- For a monaural VCR, connect the audio output of the VCR to AUDIO L (MONO) on the TV.
- Connect your S-Video cable (KV-20V60 only) to the S-Video input on the TV. S-Video will override your standard video input, providing the most stable picture.

3

Warnings and Cautions • Connecting the TV • Connecting an Antenna • Connecting a Cable Box • Connecting a VCR

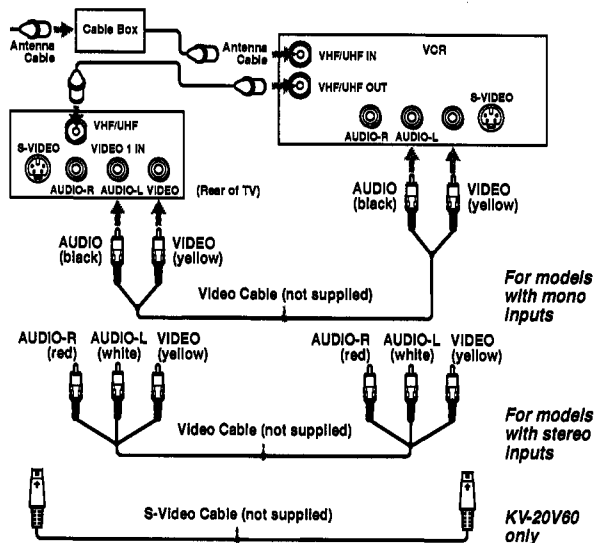

Connecting a Camcorder

KV-13M30, 13M31, 20S30, 21RS30C only

Use this connection to view a video tape from a camcorder.

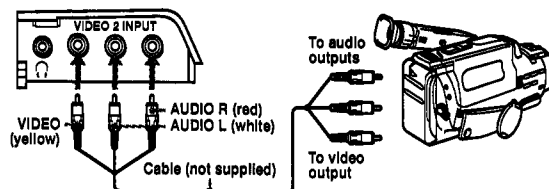

Notes

- For a monaural camcorder, connect the audio output of the camcorder to AUDIO L (MONO) on the TV.
- If you are connecting your camcorder to a monaural TV (KV-13M30, 13M31 only), plug the audio connector into the AUDIO input on the TV.
- You can also connect a camcorder to inputs on the rear of the TV.

Connecting an Audio System

KV-20S30, 21RS30C only

To listen to TV audio through a separate stereo system, connect the TV as shown below. See page 11 to switch to the external speakers.

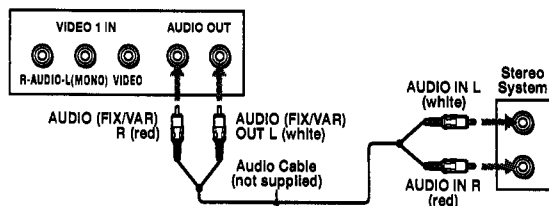

4

Step 2: Using the Remote Control

Instructions in this manual are based on using the remote control. You can also use the controls on the TV.

The menu illustrations are from KV-20M20. When features found on other models are discussed, the manual lists the models covered by that specific set of menus.

Note

- The menu disappears 90 seconds after you press a button, or immediately after you press MENU.

Inserting Batteries

Insert two size AA (R6) batteries (supplied) by matching the + and - on the batteries to the + and - inside the battery compartment. With normal use, the batteries should last for approximately six months.

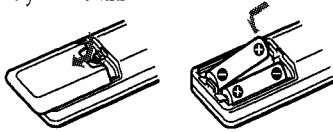

Notes

- Remove the batteries to avoid possible damage from battery leakage if you will not be using the remote control for an extended period of time.
- Handle the remote control with care. Avoid dropping it, getting it wet, or placing it in direct sunlight, near a heater, or where the humidity is high.

Changing the Menu Language

Except Canadian models

If you want to view the menus in Spanish, you can change the menu language.

- Press MENU. The Main menu appears.



- Press Δ+ or ∇- to move the cursor (▶) to ENGLISH and press RETURN.

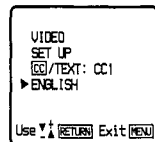
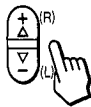

ENGLISH will turn red.

- Press Δ+ or ∇- to select ESPAÑOL and press RETURN.

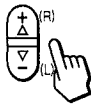

ESPAÑOL will turn green.

- Press MENU to return to the TV program.

Note

- Some parts of the Spanish menus will appear in English.

5

Step 3: Setting up Your Channels

Setting Cable TV On or Off

If you have connected the TV to a cable TV system, set CABLE to ON. If not, set CABLE to OFF.

- Press MENU.
- Move the cursor to SET UP and press RETURN.
- Move the cursor to CABLE and press RETURN.



- Press Δ+ or ∇- to select ON or OFF.
- Press RETURN.
- Press MENU to return to the TV program.

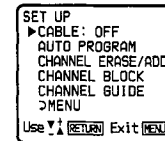

Note

- If the screen is black, the TV is set to a video input and you cannot select CABLE. Press TV/VIDEO until a channel number appears, then follow steps 1-6.

Auto Programming Your Channels

TV channels can be preset easily. First, you can store all the receivable channels automatically. Later, you can erase unwanted channels or add additional channels.

Notes

- If the TV is set to VIDEO, you cannot run AUTO PROGRAM. Press TV/VIDEO on the remote control until a channel number appears.
- It is usually best to preset channels during the day when the greater number of channels are broadcasting.

- Press MENU. The Main menu appears.

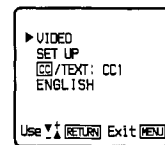

- Press Δ+ or ∇- on the remote control to move the cursor (▶) to SET UP. Press RETURN.

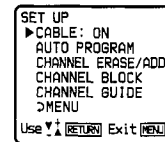
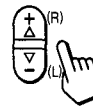

The SET UP menu appears.

- Press Δ+ or ∇- to move the cursor to AUTO PROGRAM and press RETURN.

AUTO PROGRAM appears on the screen and the TV starts scanning and presetting channels.

When all of the receivable channels are stored, AUTO PROGRAM disappears.

Note

- AUTO PROGRAM will tune in all of the channels in your area, including some with weak or scrambled signals. They will appear fuzzy on the screen. You can erase them using CHANNEL ERASE/ADD.

6

Erasing or Adding Channels

After you run AUTO PROGRAM, you can erase unnecessary channels or add new ones.

- 1 Press **MENU**.
- 2 Press **Δ+** or **∇-** to select **SET UP** and press **RETURN**.
- 3 Press **Δ+** or **∇-** to select **CHANNEL ERASE/ADD** and press **RETURN**.

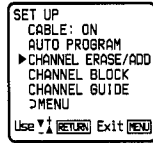
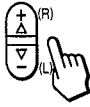

- 4 To erase or add an unwanted channel:

- (1) Press **CH +/-** or **0-9** to select the channel you want to erase or add.
- (2) Press **Δ+** or **∇-** to select **ERASE** or **ADD**.
- (3) Press **RETURN**.

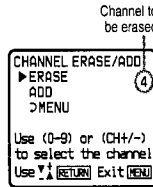

If you are erasing a channel, the “-” symbol appears next to the channel number. If you are adding a channel, the “+” symbol appears next to the channel number.

- 5 To erase or add other channels, repeat step 4.
- 6 Press **MENU** to return to the TV program.

- Note**
- If you erase or add a VHF or UHF channel, the cable TV channel with the same number is also erased or added.

Watching the TV

Press **POWER** to turn the TV on.

- Note**
- If **VIDEO** appears on the screen, press **TV/VIDEO** so that a channel number appears.

Selecting a Channel Directly

Press **0-9** to select a channel.

The channel will change after 2 seconds, or you can press **ENTER** for immediate selection.

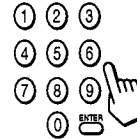

Scanning Through Channels

Press **CH +/-** until the channel you want appears.



Jumping Quickly Between Two Channels

Press **JUMP**.

The TV switches from the current channel to the previous channel that you watched.



Pressing **JUMP** again switches back to the first channel.

- Note**
- You can only jump to channels you have selected with the 0-9 keys, or back to the last channel you scanned.

Adjusting the Volume

Press **VOL +/-** to adjust the volume.

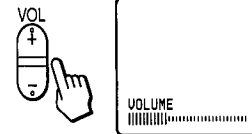

Muting the Sound

Press **MUTING**.

MUTING appears on the screen.

To restore the sound, press **MUTING** again, or press **VOL +**.



Using the VIDEO Menu

Adjusting the Video Settings

You can adjust the picture, hue, color, brightness, and sharpness of any TV image.

- 1 Press MENU.
- 2 Move the cursor (▶) to VIDEO and press RETURN.

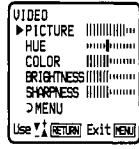

- 3 Press Δ+ or ∇- to select the feature that you want to adjust and press RETURN.

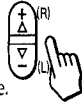

See the Adjustable Items chart for a list of the adjustments you can make.

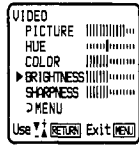

- 4 Press Δ+ or ∇- to adjust the setting of the selected feature and press RETURN.

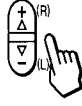

The new setting appears in the VIDEO menu.



- 5 To adjust other video settings, repeat steps 3 and 4.
- 6 Press MENU to return to the TV program.

ADJUSTABLE ITEMS

Item	Press Δ+ (R) to	Press ∇- (L) to
PICTURE	Increase the contrast	Decrease the contrast
HUE	Increase the green tones	Decrease the green tones
COLOR	Increase color intensity	Decrease color intensity
BRIGHTNESS	Brighten the picture	Darken the picture
SHARPNESS	Sharpen the picture	Soften the picture

Restoring the Factory Video Settings

- 1 To restore the factory video settings, press RESET while the VIDEO menu is displayed.
All the settings except PICTURE are restored to factory settings.

Displaying On-Screen Information

Use the DISPLAY key to check the TV's Display settings.

- 1 Press DISPLAY. 
- The channel number will be displayed. The TV will also display the MTS mode if SAP, MAIN, or MONO are selected (except KV-13M20, 13M30, 20M20). The MTS mode display disappears after 4 seconds.

- 2 Press DISPLAY again.
- XDS ON will appear on the screen. If XDS (Extended Data Service) is broadcasting, information will then appear on the screen (except KV-13M20, 14PM1, 14R20, 14R20C, 14RD1)



- 3 Press DISPLAY again.
- CC1 ON (if selected) will appear on the screen for a few seconds. Captions will then appear at the top or bottom of the screen.
- 4 To turn off Caption Vision or XDS display, press DISPLAY again until DISPLAY OFF appears.

Note
• See page 13 for more information about Caption Vision.



Watching Video Tapes

- 1 Press TV/VIDEO until the correct video input appears. 

- 2 Press PLAY on your VCR to view the video tape.

Setting the Sleep Timer

Sleep Timer allows the TV to stay on for a length of time and then shut off automatically.

- 1 Press SLEEP until the time you want appears.  
- Each time you press SLEEP, the display moves between 30, 60, 90, and OFF.
- In a few seconds, the SLEEP message disappears.
- TV WILL BE OFF SOON appears one minute before the TV shuts off.

- 2 To cancel the Sleep Timer, press SLEEP again until SLEEP OFF appears, or turn off the TV.

Watching the TV • Selecting a Channel • Scanning • Jumping • Volume • Muting • On-Screen Information • Watching Video Tapes • Sleep Timer

Additional Features

Selecting Stereo or Bilingual Programs (MTS)

KV-20S20, 20S21, 20S30, 20V60, 21PS1, 21RS20, 21RS20C, 21RS30C, 21SD1 only. Menus shown are for KV-20S20.

The Multichannel TV Sound (MTS) feature allows you to enjoy stereo sound (MAIN), Second Audio Programs (SAP), or monaural sound (MONO) when available.

- 1 Press MENU.
- 2 Move the cursor to AUDIO and press RETURN.
- 3 Move the cursor to MTS and press RETURN.
- 4 Press Δ + or ∇ - to select MAIN, SAP, or MONO.
- 5 Press MENU to return to the TV program.

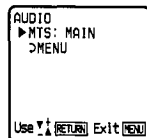
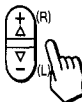

Choose	To
MAIN	Listen to stereo sound.
SAP	Listen to bilingual and other programs.
MONO	Reduce noise during poor stereo broadcasts.

Note

- The sound of non-SAP programs will be muted when SAP is selected. If there is no SAP audio, you may hear unrelated audio in English.

Setting the Speaker Switch (SPEAKER)

KV-20S30, 20V60, 21RS30C only.

You may switch off the TV speakers when you want to listen to the TV sound through a separate stereo system.

- 1 Press MENU.
- 2 Move the cursor to AUDIO and press RETURN.
- 3 Move the cursor to SPEAKER and press RETURN.
- 4 Press Δ + or ∇ - to select ON or OFF.
- 5 Press MENU to return to the TV program.



Choose	To
ON	Listen to the sound from the TV.
OFF	Turn off the TV speaker and listen to the TV's sound through external audio system speakers.

Changing Audio Out Speaker Volume

KV-20S30, 20V60, 21RS30C only.

You can control the volume of the TV program when you play the TV sound through a separate stereo system.

- 1 Press MENU.
- 2 Move the cursor to AUDIO and press RETURN.
- 3 Move the cursor to SPEAKER and press RETURN.
- 4 Press Δ + or ∇ - to set SPEAKER to OFF. Press RETURN.

- 5 Move the cursor to FIXED or VARIABLE and press RETURN. Your selection will turn yellow.
- 6 Press MENU to return to the TV program.



Choose	To
FIXED	Adjust the volume with your stereo.
VARIABLE	Adjust the volume through the TV.

Note

- Set the volume on your stereo low when switching from VAR to FIXED to avoid overloading your speakers.

Turning on Surround Sound

KV-20V60 only

Use this feature to listen to TV audio in Surround Sound mode.

- 1 Press MENU.
- 2 Move the cursor (\blacktriangleright) to AUDIO and press RETURN.
- 3 Move the cursor to SURROUND and press RETURN.
- 4 Press Δ + or ∇ - to set Surround ON or OFF.
- 5 Press MENU to return to the TV program.



Adjusting Treble, Bass, and Balance

KV-20V60 only

- 1 Press MENU.
- 2 Move the cursor (\blacktriangleright) to AUDIO and press RETURN.
- 3 Move the cursor to TREBLE, BASS, or BALANCE and press RETURN.

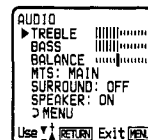

Choose	To
TREBLE	Increase or decrease high pitch sounds.
BASS	Increase or decrease low pitch sounds.
BALANCE	Change the balance between speakers.

- 4 Press Δ + or ∇ - to increase or decrease the setting.
- 5 Press RETURN to make other audio adjustments.
- 6 Press MENU to return to the TV program.

Restoring the Factory Audio Settings

- 1 To restore the factory audio settings, press RESET while the AUDIO menu is displayed.

Blocking Out a Channel (CHANNEL BLOCK)

This feature allows you to prevent children from watching selected channels.

- 1 Press MENU.
- 2 Move the cursor to SET UP and press RETURN.
- 3 Move the cursor to CHANNEL BLOCK and press RETURN.

- 4 Move the cursor to 1 or 2 and press RETURN.

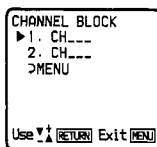

- 5 Press Δ+ or ∇- to select the channel that you want to block. Press RETURN.

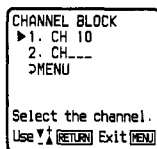

- 6 Repeat steps 4 and 5 to enter the second channel that you want to block.
- 7 Press MENU to return to the TV program.

If you switch to the blocked channel, BLOCKED appears. The screen is black and the sound is muted.

To cancel a CHANNEL BLOCK setting

- Follow steps 1–4 above.
- Press RESET.

Selecting a Caption Vision Option

Caption Vision options include CC1, 2, 3, and 4, or TEXT1, 2, 3, and 4. CC1, 2, 3, and 4 show a caption or printed version of the dialog or sound effects of a program. CC1 will be the setting for most programs. TEXT1, 2, 3, and 4 show text information on half of the screen. This text is not usually related to the program.

- Press MENU.
- Press Δ+ or ∇- to select [CC/TEXT: CC1] and press RETURN.

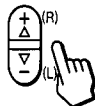

- Press Δ+ or ∇- to select the caption type (CC1, 2, 3, 4, or TEXT1, 2, 3, or 4) and press RETURN.
- Press MENU to return to the TV program.
- To view Caption Vision, press DISPLAY several times until CC1, 2, 3, 4, or TEXT1, 2, 3, 4 ON is displayed if broadcasting. The caption will appear in a few seconds.
- To turn off Caption Vision, press DISPLAY until DISPLAY OFF appears.

Notes

- Captions disappear for a few seconds when you press the MUTING button.
- Captions may appear with a white box or other errors if you have poor reception of the channel.

Customizing the Channel Number Buttons (CHANNEL GUIDE)

You can assign up to 12 of your favorite channels to Channel Guide locations and switch to them with the Channel Guide.

- Press MENU.
- Press Δ+ or ∇- to select SET UP and press RETURN.
- Press Δ+ or ∇- to select CHANNEL GUIDE and press RETURN.

- 4 Press RETURN again to move the cursor to the number pad.

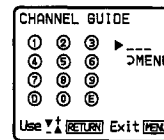

- 5 Press Δ+ or ∇- to select a number on the Channel Guide (the button number will turn red) and press RETURN.

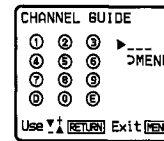

The ___ turns red.

Buttons 0–9, DISPLAY (D) and ENTER (E) are available for Channel Guide access.

- 6 Press Δ+ or ∇- to select the channel that you want to assign to that button, and press RETURN.

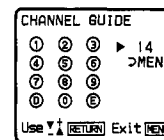

The TV will switch to that channel.

- Repeat steps 5–7 to set other channels.
- Press MENU to return to the current TV program.

To remove a CHANNEL GUIDE setting

- Repeat steps 1–6 to select the channel that you want to remove.
- Press RESET.

Using the Channel Guide

- Press CH GUIDE.

The Channel Guide shows button numbers and the channels assigned to them.

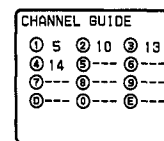

- Press 0–9, DISPLAY or ENTER on the remote control to switch to the channel you want to view.
- To cancel the CHANNEL GUIDE display without selecting a channel, press CH GUIDE again.

Listening with Headphones or an Earphone

Plug the headphones or earphone into the jack on the front of the TV. Using headphones will turn off the sound to the TV speakers. KV-13M20 is shown below.

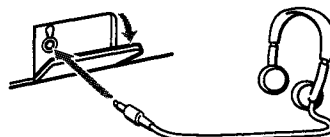

Notes

- To prevent hearing damage due to sudden or prolonged excessive volume, do not set the volume too high while listening.
- If your TV is monaural, the monaural sound will be heard from both headphones.

SECTION 2 DISASSEMBLY

2-1. REAR COVER REMOVAL

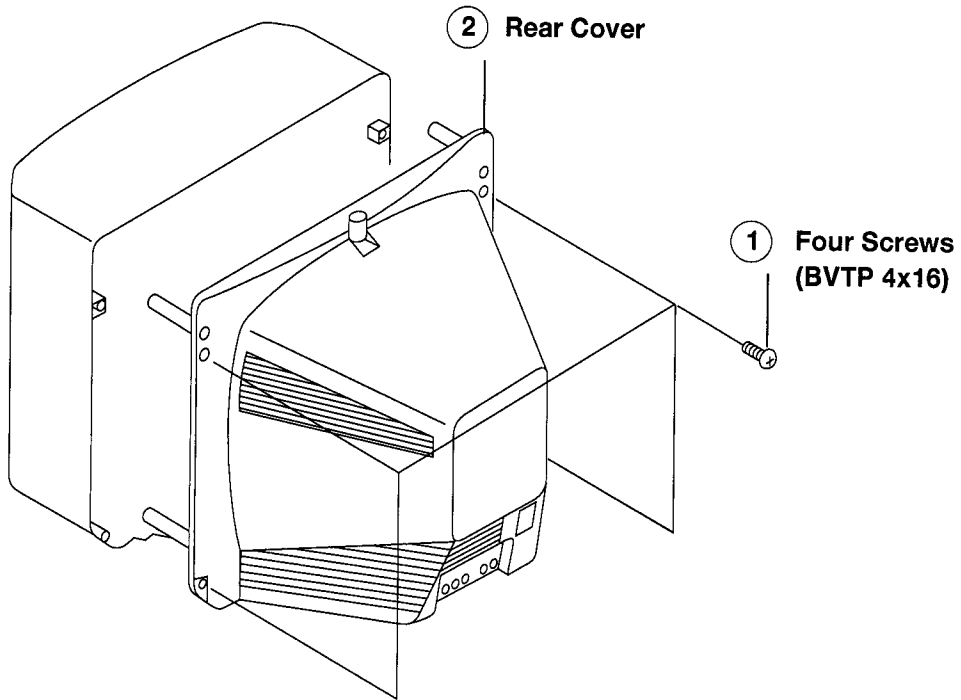

2-2. A BOARD REMOVAL

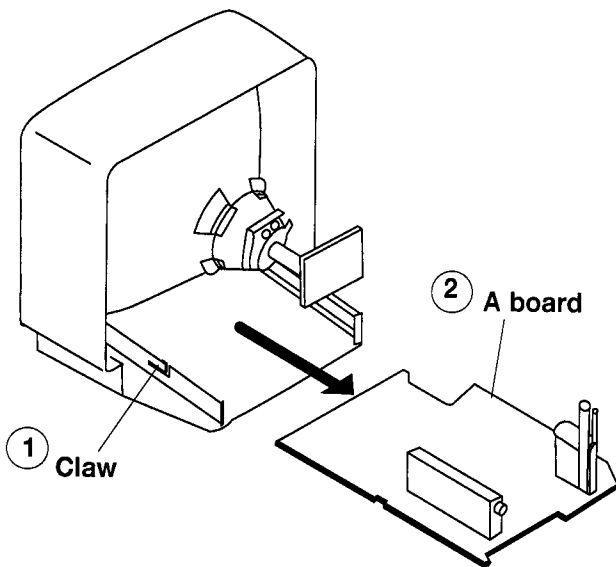

2-3. SERVICE POSITION

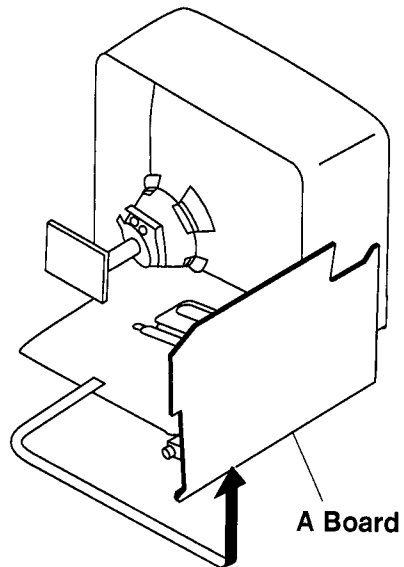

WARNING Before removing anode cap:

H.V. remains in the CRT even after the power is disconnected.

To avoid electrical shock before attempting to remove the anode cap, discharge CRT: Short between anode and CRT coating earth ground strap.

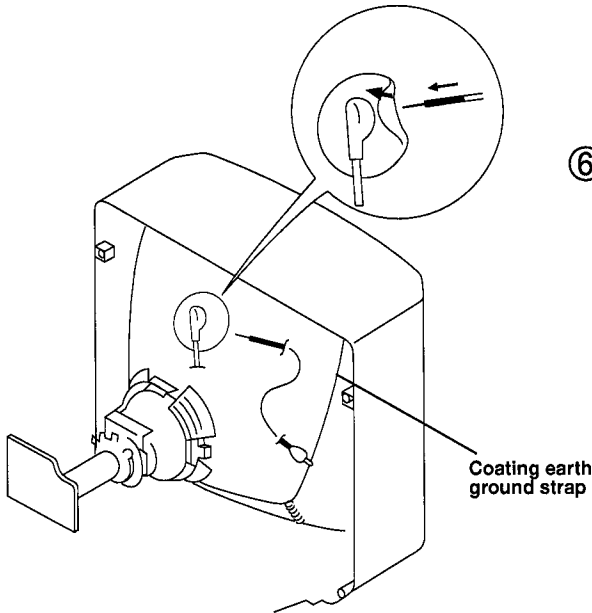

2-4. PICTURE TUBE REMOVAL

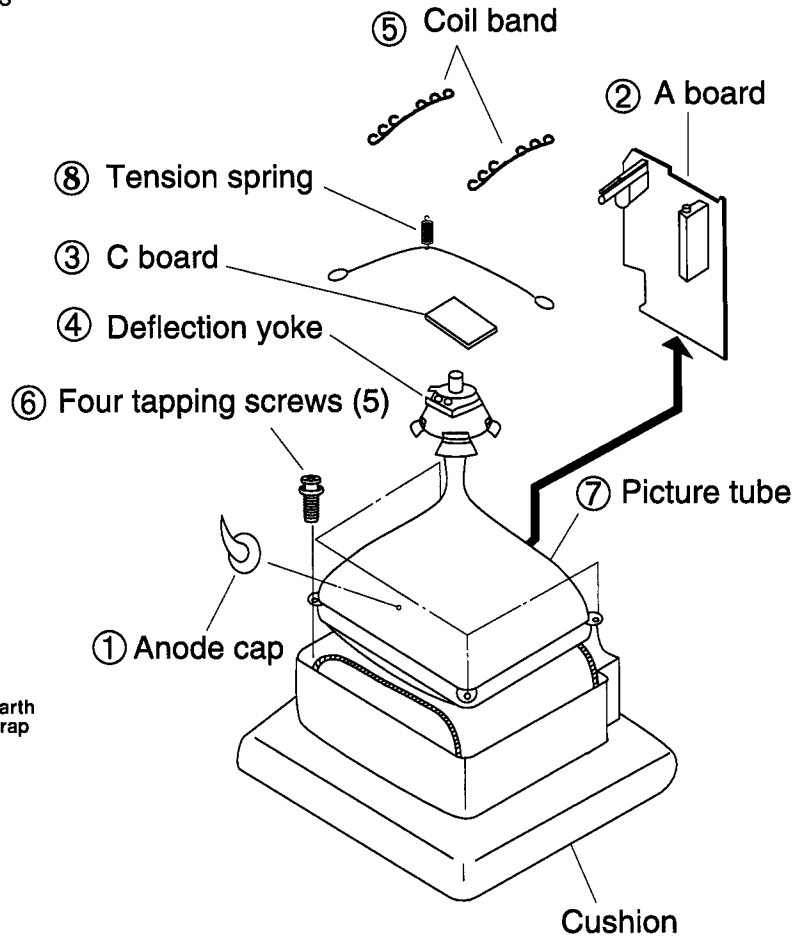

• REMOVAL OF ANODE-CAP

NOTE: Short circuit the anode of the picture tube and the anode cap to the metal chassis, CRT shield or carbon painted on the CRT after removing the anode.

• REMOVING PROCEDURES

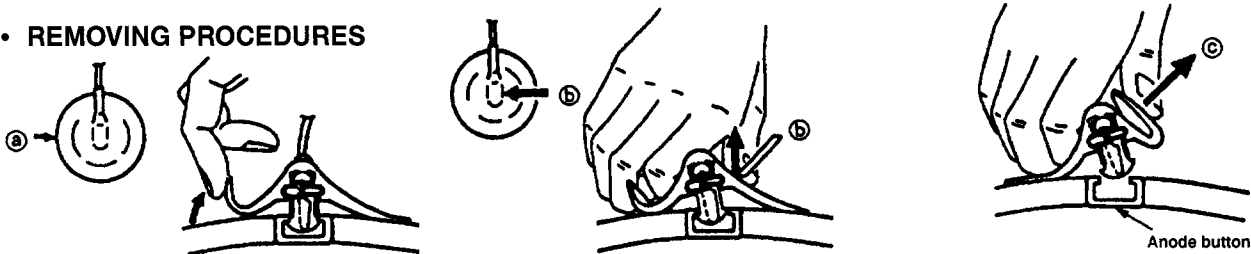

① Turn up one side of the rubber cap in the direction indicated by the arrow ①.

② Using a thumb pull up the rubber cap firmly in the direction indicated by the arrow ②.

③ When one side of the rubber cap is separated from the anode button, the anode-cap can be removed by turning up the rubber cap and pulling up it in the direction of the arrow ③.

• HOW TO HANDLE AN ANODE-CAP

- ① Don't damage the surface of anode-caps with sharp shaped material!
- ② Don't press the rubber so as not to damage the inside of anode-caps. A material fitting called a shatter-hook terminal is built into the rubber cap.
- ③ Don't turn over the foot of rubber cap. The shatter-hook terminal will stick out or damage the rubber cap.

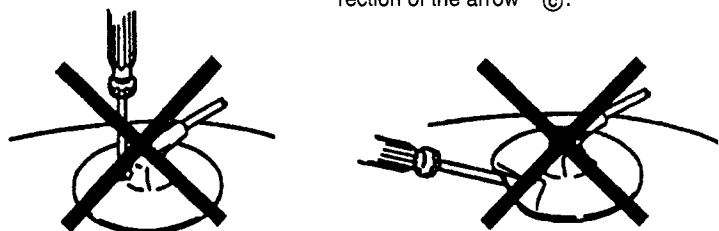

SECTION 3 SET-UP ADJUSTMENTS

- The following adjustments should be made when a complete realignment is required or a new picture tube is installed.
- These adjustments should be performed with rated power supply voltage unless otherwise noted.

The controls and switch should be set as follows unless otherwise noted:

PICTURE control normal

BRIGHTNESS control normal

Perform the adjustments in order as follows:

1. Beam Landing
2. Convergence
3. Focus
4. Screen (G2) and White Balance

Note: Test Equipment Required

1. Color bar Pattern Generator
2. Degausser
3. DC Power Supply
4. Digital multimeter

.....
Preparation:

- Feed in the white pattern signal.
- Before starting, degauss the entire screen.

3-1. BEAM LANDING

1. Input a raster signal with the pattern generator.
2. Loosen the deflection yoke mounting screw, and set the purity control to the center as shown in Fig.2.
3. Turn the raster signal of the pattern generator to green.
4. Move the deflection yoke backward, and adjust with the purity control so that green is in the center and red and blue are at the sides evenly. (Fig.3)
5. Move the deflection yoke forward, and adjust so that the entire screen becomes green. (Fig.1)
6. Switch over the raster signal to red and blue and confirm the condition.
7. When the position of the deflection yoke is determined, tighten it with the deflection yoke mounting screw.
8. When landing at the corner is not right, adjust by using the disk magnets. (Fig.4)

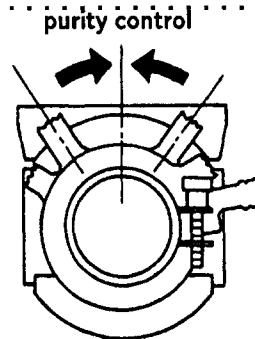

Fig. 2

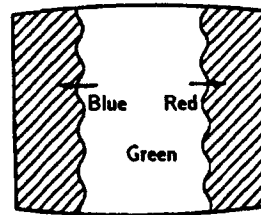

Fig. 3

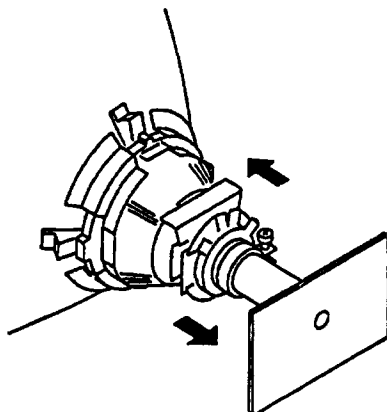

Fig. 1

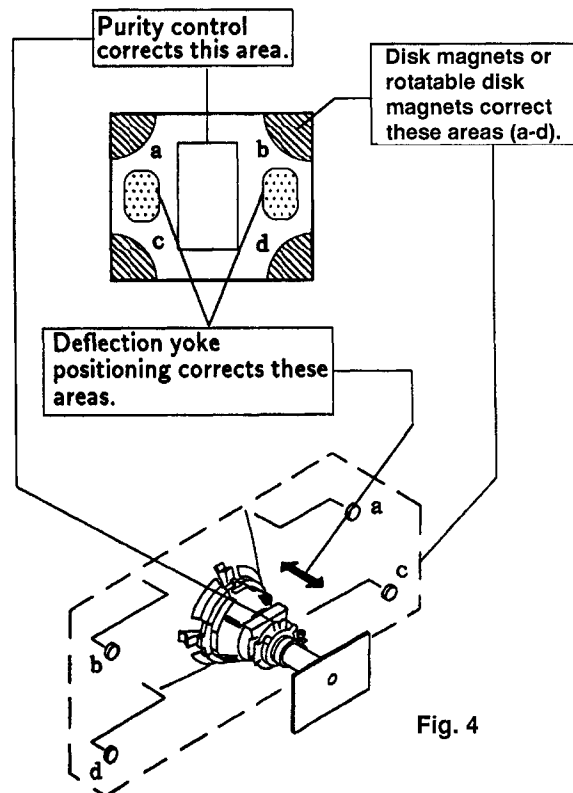

Fig. 4

3-2. CONVERGENCE

Preparation:

- Before starting, perform FOCUS, V.LIN and V. SIZE adjustments.
 - Set BRIGHTNESS control to minimum.
 - Feed in dot pattern.
- (1) Vertical Static Convergence

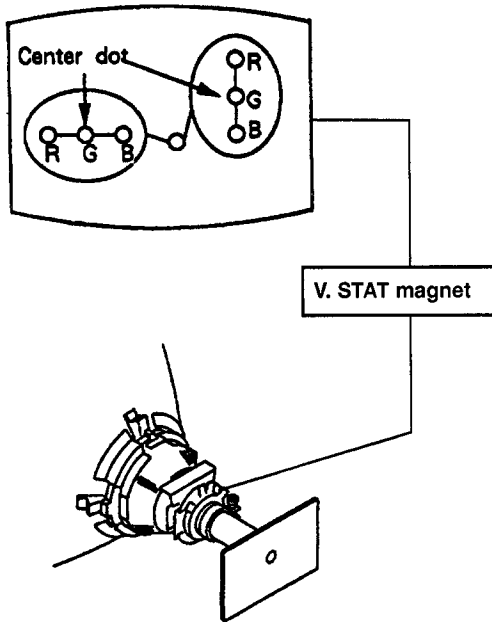
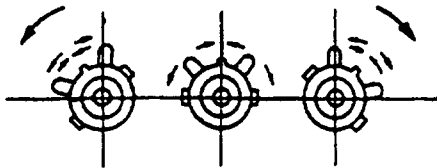
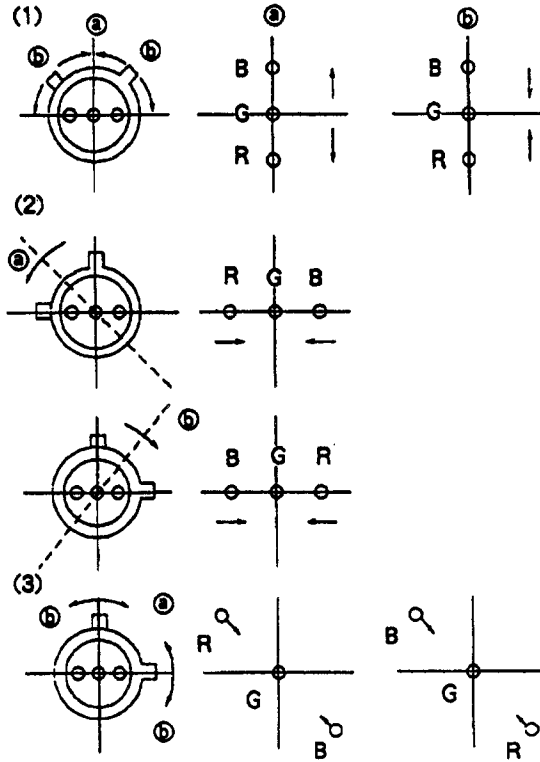

Fig. 5

1. Adjust V. STAT magnet to converge red, green and blue dots in the center of the screen. (Vertical movement)
- Tilt the V. STAT magnet and adjust static convergence to open or close the V. STAT magnet.



2. When the V. STAT magnet is moved in the direction of arrow (a) and (b), red, green, and blue dots move as shown below.



If the blue dot does not converge with red and green dots, perform the following steps:

Move BMC magnet (a) to correct insufficient H.static convergence.

Rotate BMC magnet (b) to correct insufficient V.static convergence.

In either case, repeat Beam Landing Adjustment.

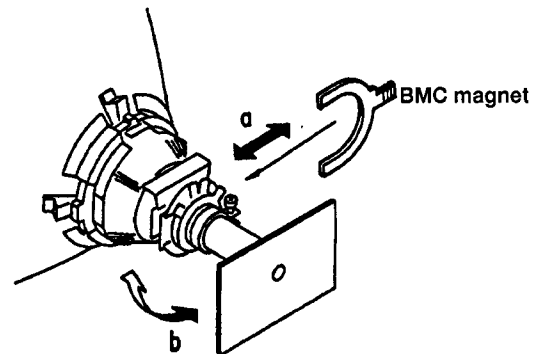

Fig. 6

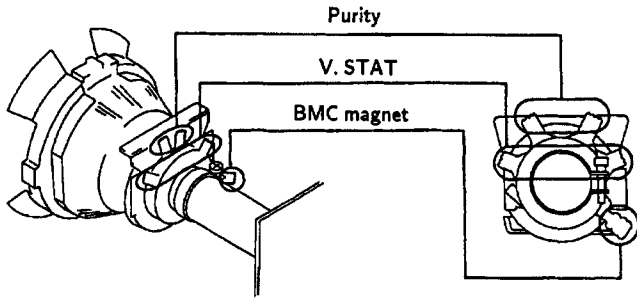

Fig. 7

(2) Dynamic Convergence Adjustment

Preparation:

- Before starting to perform Horizontal and Vertical static convergence Adjustment.
1. Slightly loosen deflection yoke screw.
 2. Remove deflection yoke spacers.
 3. Move the deflection yoke for best convergence as shown below.
 4. Tighten the deflection yoke screw.
 5. Install the deflection yoke spacers.

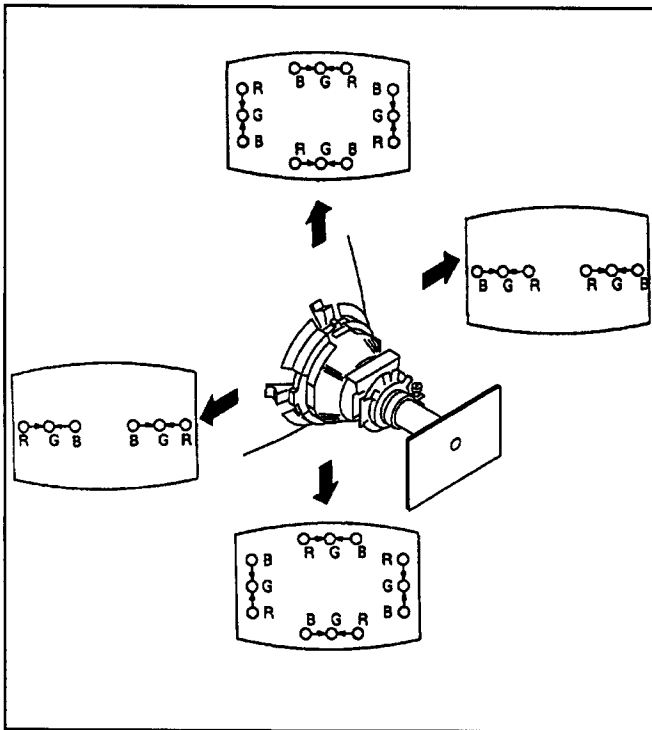

Fig. 8

(3) Screen-corner Convergence

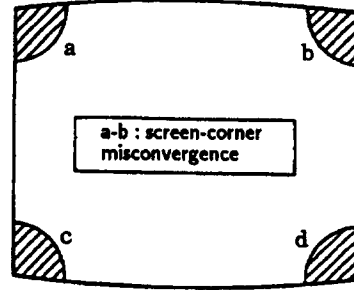
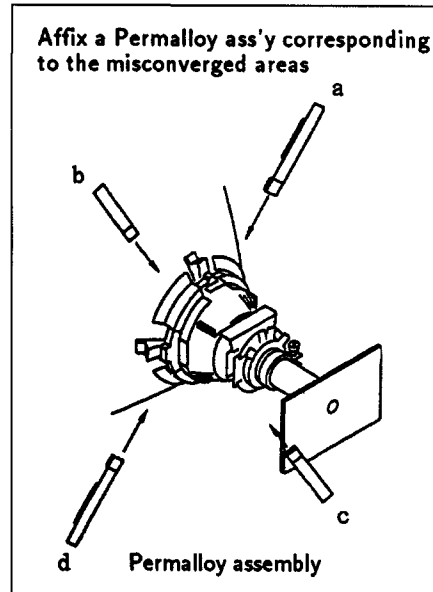

Fig. 9



3-3. FOCUS

Adjust FOCUS control for best picture.

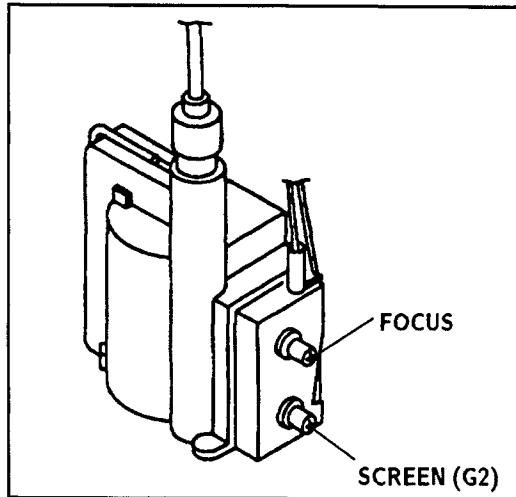

Fig. 10

3-4. SCREEN (G2)

1. Input a dots pattern.
2. Set the PIC, BRT controls at minimum and COLOR control at normal.
3. Adjust S BRT, G CUT, B CUT in service mode so that voltages on the red, green, and blue cathodes are 170V dc with an oscilloscope as shown in Fig. 11.
4. Observe the screen and adjust SCREEN (G2)VR to obtain the faintly visible background of dot signal.

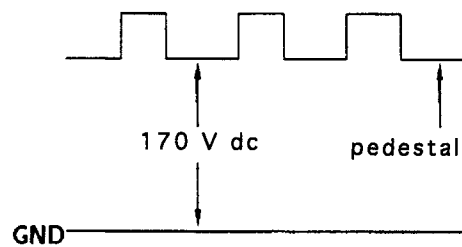

Fig. 11

3-5. METHOD OF SETTING THE SERVICE ADJUSTMENT MODE

SERVICE MODE PROCEDURE

1. Standby mode. (Power off)
2. **DISPLAY** → **5** → **VOL(+)** → **POWER** on the Remote Commander. (Press each button within a second.)

SERVICE ADJUSTMENT MODE IN

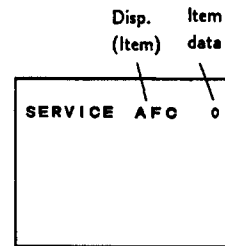

3. The CRT displays the item being adjusted.
4. Press **1** or **4** on the Remote Commander to select the item.
5. Press **3** or **6** on the Remote Commander to change the data.
6. Press **MUTING** then **ENTER** to write into memory.

SERVICE ADJUSTMENT MODE MEMORY

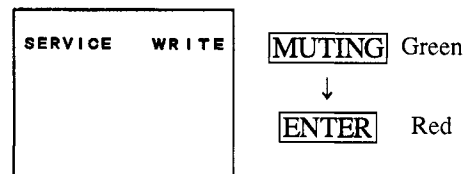

7. Turn set off and on to exit.

3-6. WHITE BALANCE ADJUSTMENTS

1. Input an entire white signal.
2. Set to service adjustment mode.
3. Set the PICTURE and BRIGHT to minimum.
4. Adjust with SBRT if necessary.
5. Select G CUT and B CUT with **1** and **4**.
6. Adjust with **3** and **6** for the best white balance.
7. Set the PICTURE and BRIGHT to maximum.
8. Select GDRV and BDRV with **1** and **4**.
9. Adjust with **3** and **6** for the best white balance.
10. Write into the memory by pressing **MUTING** then **ENTER**.

SECTION 4 SAFETY RELATED ADJUSTMENTS

A BOARD

☒ R525 CONFIRMATION METHOD (HV HOLD-DOWN CONFIRMATION) AND READJUSTMENTS

The following adjustments should always be performed when replacing the following components (marked with ☒ on the schematic diagram).

IC301, IC502, IC601, D505, D506, D507, D510, DY, C503, C511, C513, C528, R511, R519, R520, R523, R525, R527, R559, R560, R617, R618, T504 (FBT)

1. Preparation before confirmation

- 1) Turn the POWER switch ON. Input an entirely white signal and set the PICTURE and BRIGHT controls to maximum.
- 2) Confirm that the voltage at TP85 is more than 90VDC when the set is operating normally with 120.0 ± 2.0 VAC supply.

2. Hold-down operation confirmation

- 1) Connect the current meter between Pin 11 of the FBT (T504) and the PCB land where Pin 11 would normally attach.
- 2) Input a white signal and adjust the ABL current to be $1440 \pm 100\mu\text{A}$ using the PICTURE and the BRIGHT controls.
- 3) Confirm the voltage of A board TP-91 is 113.2 ± 0.5 VDC
- 4) Connect the Digital Voltmeter and DC power supply via 1SS119 to TP-85.
- 5) Increase the DC power voltage gradually until the picture blanks out.
- 6) Read the digital voltmeter indication.
- 7) Turn DC power source off immediately.

STANDARD

Less than or equal to 127.0 VDC

- 8) Input a dot signal and adjust the ABL current to be $95+100/-95\mu\text{A}$ using the PICTURE and the BRIGHT controls.
- 9) Confirm the voltage of A board TP-91 is 116.7 ± 0.5 VDC
- 10) Repeat steps from (4) to (7).

STANDARD

Less than or equal to 127.0 VDC

3. Hold-down readjustment

If the current setting indicated in step 2-2 cannot be met, readjustment should be performed by altering the resistance value of R525 (a component marked with ☒).

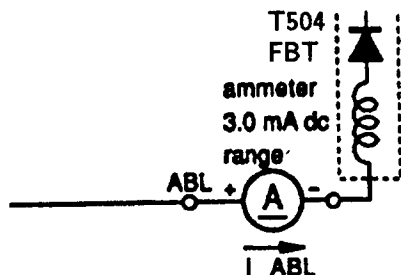

B+ VOLTAGE CONFIRMATION AND ADJUSTMENT

The following adjustments should always be performed when replacing the following components. (marked with ☒ on the schematic diagram).

IC001, IC601, R030, R617, R618, R629, R630, R651, R652, R654, R655, R656

- 1) Supply 130 ± 2.0 V AC to the set with a variable auto transformer.
- 2) Input a dot signal.
- 3) Set the PICTURE control and the BRIGHT control to minimum condition.
- 4) Set to service adjustment mode.
- 5) Select PADJ with **[1]** and **[4]**.
- 6) Adjust with **[6]** to the 0 level.
- 7) Confirm the voltage of A BOARD TP-91 is less than 123.0V DC.
- 8) If step 7) is not satisfied, replace the components, repeat the above steps.
- 9) Supply 120.0 ± 2.0 VAC to the set with a variable auto transformer.
- 10) Adjust with **[3]** and **[6]** for the 116.7 ± 0.5 V DC.
- 11) Write into the memory by pressing **[MUTING]** then **[ENTER]**.

DIGITAL MULTIMETER

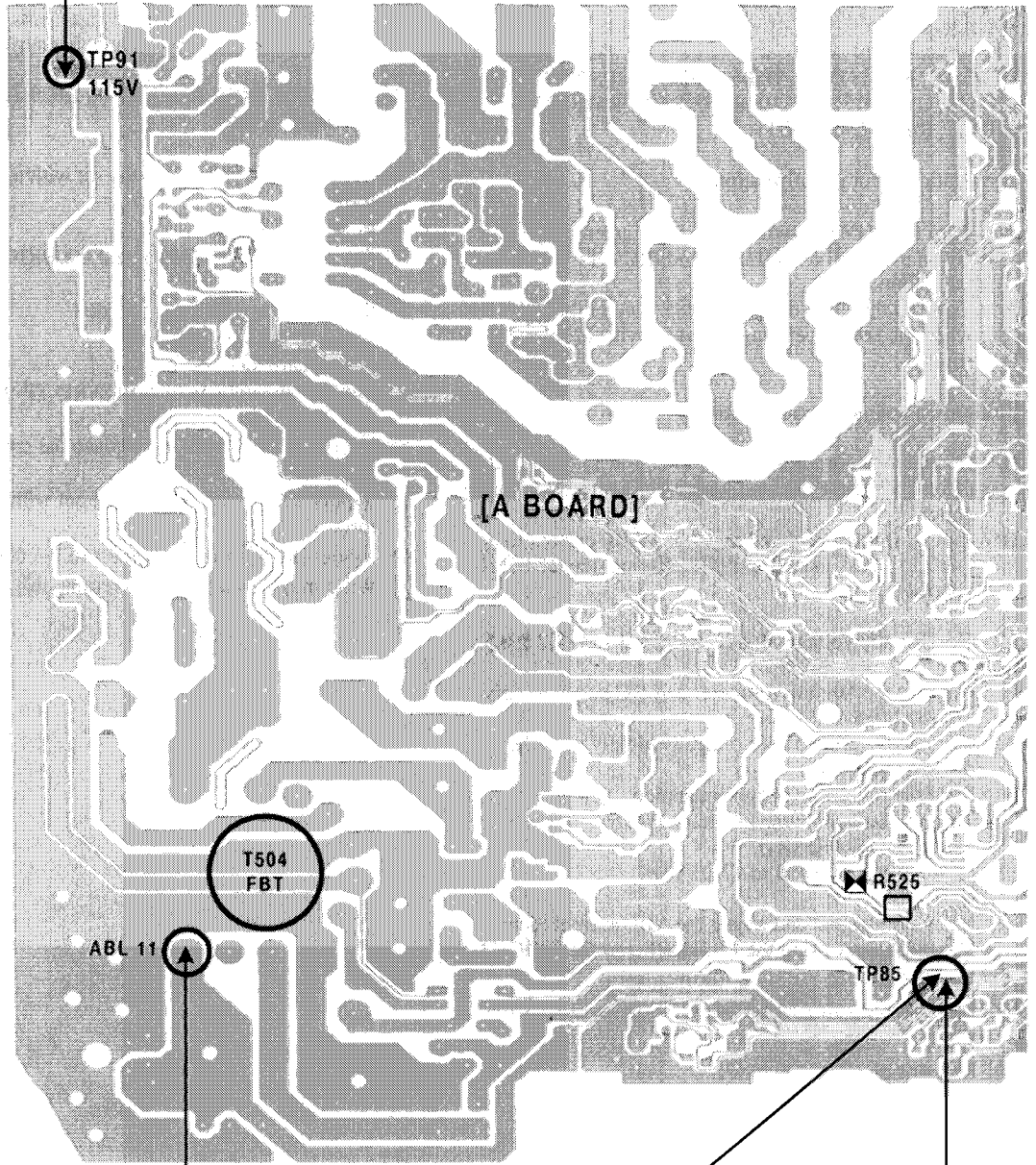
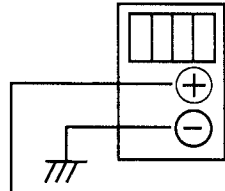

AMMETER
3mA dc range

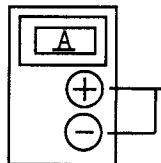

POWER SUPPLY

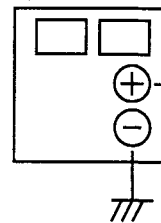

1SS119

DIGITAL MULTIMETER

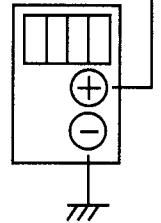

SECTION 5 CIRCUIT ADJUSTMENTS

5-1. ELECTRICAL ADJUSTMENT BY REMOTE COMMANDER

Use Remote Commander (RM-Y116) to perform circuit adjustments on this model.

NOTE : Test Equipment Required.

1. Pattern Generator
2. Frequency Counter
3. Digital Multimeter
4. Audio OSC

1. METHOD OF SETTING THE SERVICE ADJUSTMENT MODE

SERVICE MODE PROCEDURE

1. Standby mode. (Power off)
2. **DISPLAY** → **5** → **VOL (+)** → **POWER** on the Remote Commander. (Press each button within a second.)

SERVICE ADJUSTMENT MODE IN

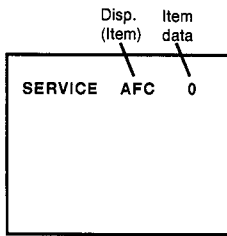

3. The CRT displays the item being adjusted.
4. Press **1** or **4** on the Remote Commander to select the item.
5. Press **3** or **6** on the Remote Commander to change the data.
6. Press **MUTING** then **ENTER** to write into memory.

SERVICE ADJUSTMENT MODE MEMORY

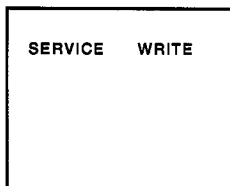

MUTING Green
↓
ENTER Red

7. Press **8** then **ENTER** on the Remote Commander to initialize.

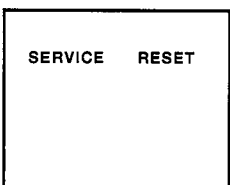

Carry out step 7) when adjusting IDs 0 to 4 and when replacing and adjusting IC003.

Factory original setting

8. Turn set off and on to exit.

2. MEMORY WRITE CONFIRMATION METHOD

1. After adjustment, pull out the plug from the AC outlet, then replace the plug in the AC outlet again.
2. Turn the power switch ON and set to service mode.
3. Call the adjusted items again to confirm they were adjusted.

3. ADJUST BUTTONS AND INDICATOR

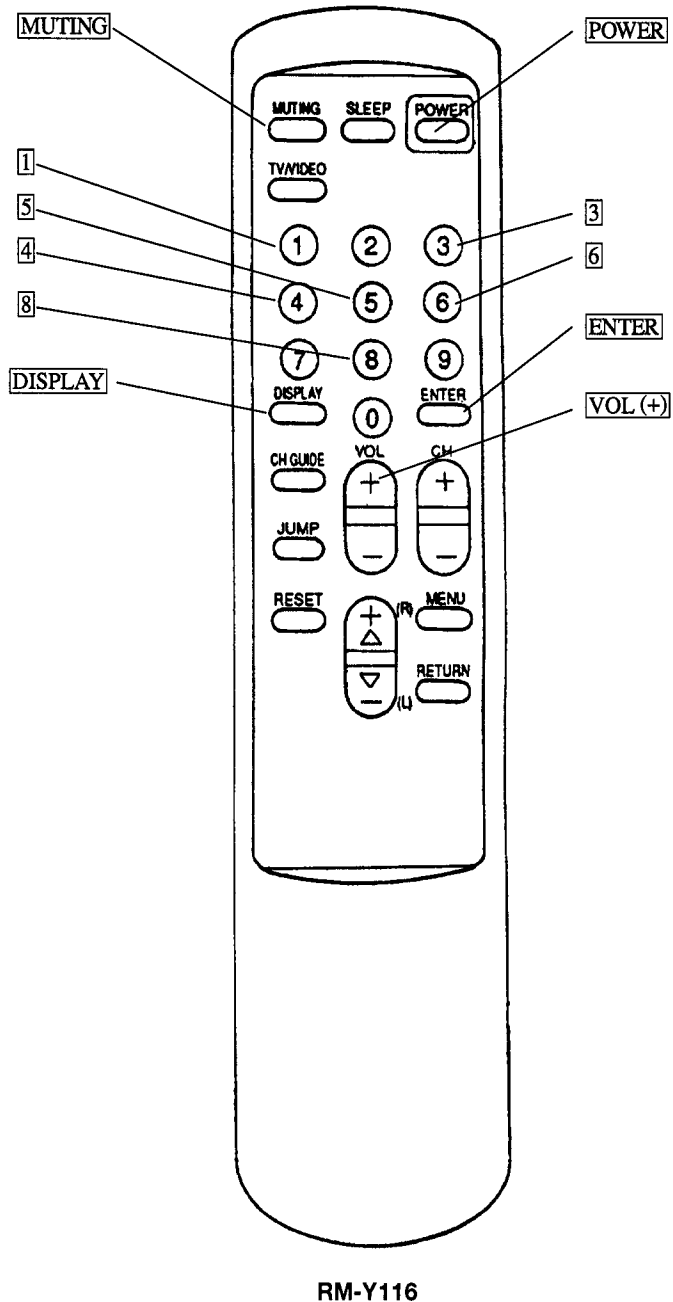

RM-Y116

4. AN ITEM OF ADJUSTMENTS

No.	Disp.	Item	Data range	Avg. data
1	SYS	Color System	0~3	1
2	AFC	AFC Loop Gain	0~3	*1
3	VPOS	V. Position	0~31	15
4	VSIZ	V. Size	0~63	20
5	VLIN	V. Linearity	0~15	6
6	VSCO	S. Correction	0~15	7
7	HPOS	H. Position	0~15	11
8	GDRV	Green-Drive	0~31	17
9	BDRV	Blue-Drive	0~31	14
10	GCUT	Green-Cutoff	0~15	7
11	BCUT	Blue Cut Off	0~15	7
12	TOT	Chroma TOT-Filter	0, 1	*1
13	NR	Noise Reduction	0, 1	*0
14	SCON	Sub-Contrast	0~15	6
15	SHUE	Sub-Hue	0~15	8
16	SCOL	Sub-Color	0~15	8
17	SBRT	Sub-Brightness	0~63	34
18	SSHP	Sub-Sharpness	0~15	11
19	RON	Red-Off	0, 1	*1
20	GON	Green-Off	0, 1	*1
21	BON	Blue-Off	0, 1	*1
22	PREL	Pre-Over Shoot	0~7	4
23	AXIS	Axis SW	0, 1	1
24	DCOL	Dynamic-Color	0, 1	*0
25	REF	Reference-Position	0~3	2
26	ABLM	ABL Mode	0~3	2
27	CROM	Chroma Trap SW	0, 1	1
28	OSDL	OSD Level	0, 1	0
29	Y-DC	DC Transmission	0~7	5
30	GAMM	Gamma	0~7	0
31	VEXT	V Sync Extend	0, 1	1
32	VZOM	HV Comp	0~7	4
33	CDMD	V Countdown	0, 1	0
34	RGBL	RGB Limit	0~3	0
35	YDLY	Y Delay	0~3	0
36	SBAL	Left-Volume	0~15	7
37	SBAS	Sub-Bass	0~15	7
38	STRE	Sub-Treble	0~15	7
39	PHOR	Horizontal Size	0~63	8
40	PE-W	E-W Correction	0~63	23
41	PCOR	E-W Corner	0~15	7
42	PTRP	Trap Correction	0~63	16
43	HCMP	H Compensation	0~15	6
44	DISP	Display Position	0~63	8
45	PADJ	B+ Adjustment	0~63	34
46	ID-0	ID-0	0~256	by Model
47	ID-1	ID-1	0~256	by Model
48	ID-2	ID-2	0~256	by Model
49	ID-3	ID-3	0~256	by Model
50	ID-4	ID-4	0~256	by Model

* : Set-up value

Note: No.1 through 50 show adjustment order.

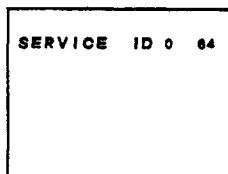

Note: IC001 on circuit board A inputs a V. sync signal to pin ⑤ and is always in operation. If a V. sync signal is input to pin ⑤ there will be a waiting period of 2-4 seconds, and the power is shut off. When entering the service mode, the above function is cancelled and operation is possible.

Adjust the function values as shown below when IC003 on A board is replaced.

KV-20M20 (CND)

No.	Disp.	Data
46	ID-0	9
47	ID-1	1
48	ID-2	0
49	ID-3	0
50	ID-4	23

KV-20M20 (US)

No.	Disp.	Data
46	ID-0	25
47	ID-1	1
48	ID-2	0
49	ID-3	0
50	ID-4	23

KV-20S20 (CND)

No.	Disp.	Data
46	ID-0	9
47	ID-1	1
48	ID-2	3
49	ID-3	1
50	ID-4	23

KV-20S20/20S21 (US)

No.	Disp.	Data
46	ID-0	25
47	ID-1	1
48	ID-2	3
49	ID-3	1
50	ID-42	23

KV-21RS20(E)/21SD1/21PS1(MEX)

No.	Disp.	Data
46	ID-0	25
47	ID-1	1
48	ID-2	3
49	ID-3	3
50	ID-42	23

KV-20S30 (CND)

No.	Disp.	Data
46	ID-0	9
47	ID-1	3
48	ID-2	11
49	ID-3	1
50	ID-4	23

KV-20S30 (US)

No.	Disp.	Data
46	ID-0	25
47	ID-1	3
48	ID-2	11
49	ID-3	1
50	ID-4	23

KV-21R20(E)/21RD1/21PM1(MEX)

No.	Disp.	Data
46	ID-0	25
47	ID-1	1
48	ID-2	0
49	ID-3	2
50	ID-4	23

5-2. A BOARD ADJUSTMENTS

RF AGC ADJUSTMENT (IF BLOCK VR)

1. Input a color-bar signal.
2. Adjust AGC VR of TU101 so that snow, noise, and cross-modulation disappear from the picture.
3. Verify picture quality on each channel.

H. FREQUENCY ADJUSTMENT

1. Input a monoscope signal.
2. Set to Service adjustment Mode.
3. Connect a frequency counter to base of Q550 (TP-86 H. DRIVE)
4. Select the item of AFC, set to 3 level (free run).
5. Check H. frequency for the 15734 ± 60 Hz.
6. Select the item of AFC again, adjust the level "0".
7. Write into the memory by pressing **MUTING** then **ENTER**.

V. FREQUENCY ADJUSTMENT

1. Select video 1 with no signal input.
2. Set the conditions with standard setting.
3. Connect a capacitor (10 μ F) across pin ④ of IC301 (V. SYNC) and ground.
4. Connect the frequency counter across CN501 VDY (+) connector and ground.
5. Check V. frequency for the 59 ± 0.5 Hz.
6. Disconnect a capacitor from IC301.

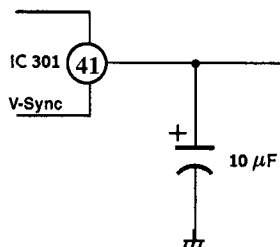

CHROMA TRAP ADJUSTMENT (CROM)

1. Input a red signal.
2. Set to Service adjustment Mode.
3. Connect an oscilloscope CN703 Pin ① (R OUT) of C board ground.
4. Select CROM with **1** and **4**.
5. Adjust with **3** and **6** for the 0 level.

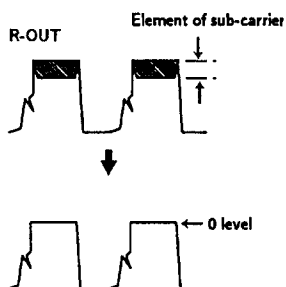

6. Write into the memory by pressing **MUTING** then **ENTER**.

SUB CONTRAST ADJUSTMENT (SCON)

1. Input a color-bar signal.
2. Select the red color.
3. Set to Service adjustment Mode.
4. Set the conditions as follows.

PICTURE MAX
 COLOR MIN
 BRIGHT CENTER

R ON ON (1)
 G ON OFF (0)
 B ON OFF (0)

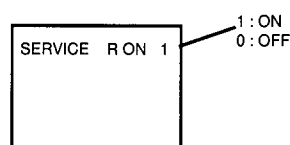

5. Connect an oscilloscope to CN703 Pin ① (R OUT) of C board and ground.
6. Select SCON with **1** and **4**.
7. Adjust with **3** and **6** for the 1.6 ± 0.05 Vp-p.

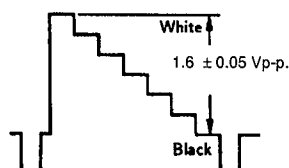

8. Write the memory by pressing **MUTING** then **ENTER**.
9. Return the following back to normal after adjustment.

PICTURE MAX
 COLOR CENTER
 BRIGHT CENTER

R ON ON (1)
 G ON ON (1)
 B ON ON (1)

DISPLAY POSITION ADJUSTMENT (DISP)

1. Input a color-bar signal.
2. Set to Service adjustment Mode.
3. Select DISP with **1** and **4**.
4. Adjust with **3** and **6** for the bar center.
5. Write the memory by pressing **MUTING** then **ENTER**.
6. Check if the text is displayed on the screen.

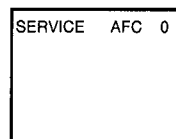

SUB BRIGHT ADJUSTMENT (SBRT)

1. Input a cross-hatch signal.
2. Set to service adjustment mode.
3. Set the PICTURE and BRIGHT to minimum.
4. Select SBRT with **1** and **4**.
5. Adjust with **3** and **6** to obtain a faintly visible cross-hatch.
6. Write into the memory by pressing **MUTING** then **ENTER**.

SUB HUE, SUB COLOR ADJUSTMENT (SHUE, SCOL)

1. Input a color-bar signal.
2. Set to Service adjustment Mode.
3. Connect an oscilloscope to CN703 Pin **3** (B OUT) of C board.
4. Select SHUE and SCOL with **1** and **4**.
5. Adjust with **3** and **6** for the $V1 = V4$ (SCOL) and $V2 = V3$ (SHUE).

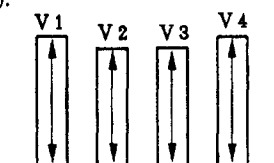

6. After Sub-Color/Hue adjustment, increase 2 steps on (SCOL).
7. Write into the memory by pressing **MUTING** then **ENTER**.

V. SIZE ADJUSTMENT (VSIZ)

1. Input a cross-hatch signal.
2. Set to Service adjustment Mode.
3. Select VSIZ with **1** and **4**.
4. Adjust with **3** and **6** for the best vertical size.
5. Write into the memory by pressing **MUTING** then **ENTER**.

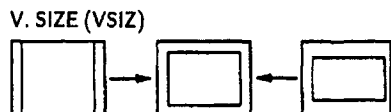

V. CENTER ADJUSTMENT (VPOS)

1. Input a cross-hatch signal.
2. Set to Service adjustment Mode.
3. Select VPOS with **1** and **4**.
4. Adjust with **3** and **6** for the best vertical center.
5. Write into the memory by pressing **MUTING** then **ENTER**.

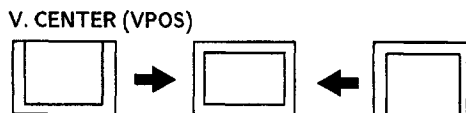

H. CENTER ADJUSTMENT (HPOS)

3. Select HPOS with **1** and **4**.
4. Adjust with **3** and **6** for the best horizontal center.
5. Write into the memory by pressing **MUTING** then **ENTER**.

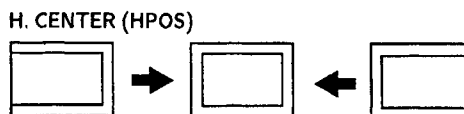

V LINEARITY (VLIN) AND V CORRECTION (VSCO) ADJUSTMENTS.

1. Input a cross-hatch signal.
2. Set to Service adjustment Mode.
3. Select VLIN and VSCO with **1** and **4**.
4. Adjust with **3** and **6** for the best picture.
5. Write the memory by Pressing **MUTING** then **ENTER**.

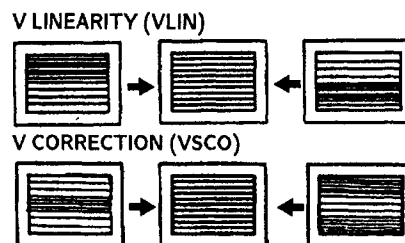

Note : Perform this adjustment after checking H. FREQUENCY.

1. Input a cross-hatch signal.
2. Set the Service adjustment Mode.

6-1. BLOCK DIAGRAMS

SECTION 6
DIAGRAMS

KV-20M20/21R20/21RD1/21PM1/20S20
KV-20S21/21RS20/21SD1/21PS1/20S30
RM-Y116

KV-20M20/21R20/21RD1/21PM1/20S20
KV-20S21/21RS20/21SD1/21PS1/20S30
RM-Y116

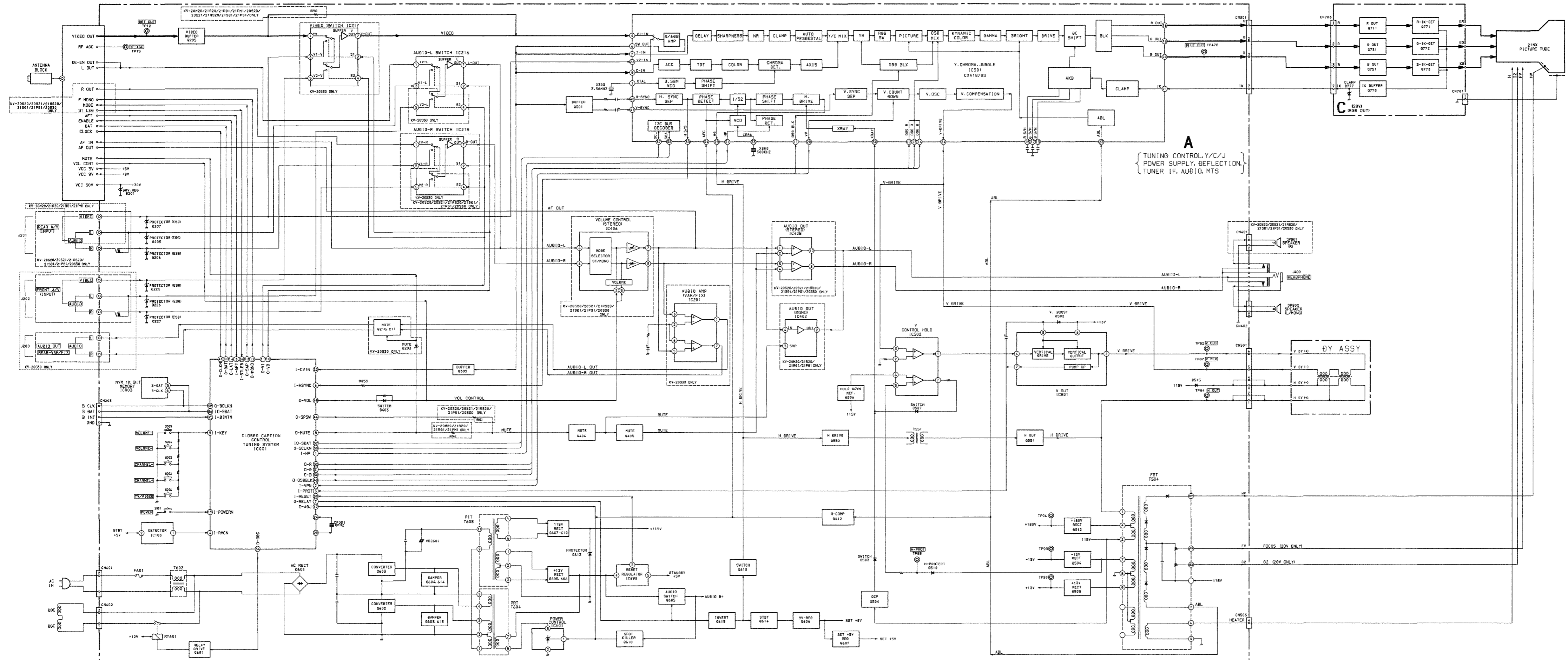

6-2. Circuit Boards Location

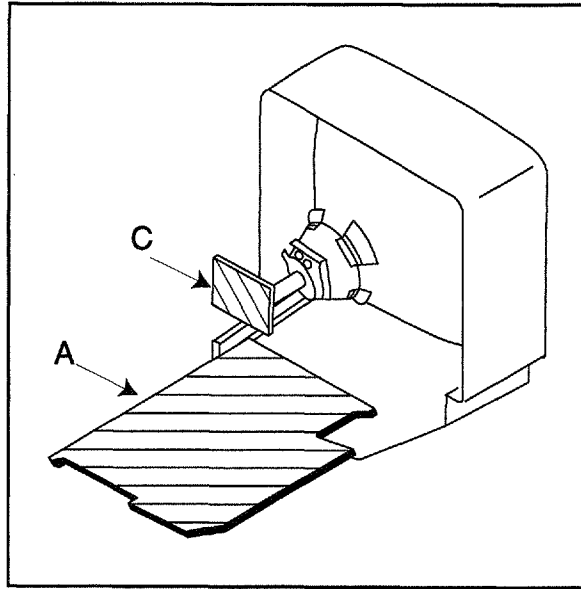

6-3. Printed Wiring Boards and Schematic Diagrams

Note:

- All capacitors are in μF unless otherwise noted. pF : μF 50WV or less are not indicated except for electrolytic and tantalums.
- All electrolytics are 50V unless otherwise specified
- Indication of resistance, which does not have one for rating electrical power, is as follows:

Pitch: 5mm
Rating electrical power 1/4W

- All resistors are in ohms.
 $K\Omega=1000\Omega$, $M\Omega=1000K\Omega$
- nonflammable resistor.
- Δ : internal component.
- panel designation and adjustment for repair.
- All variable and adjustable resistors have characteristic curve B, unless otherwise noted.
- The components identified by \square in this manual have been carefully factory-selected for each set in order to satisfy regulations regarding X-ray radiation. Should replacement be required, replace only with the value originally used.
- When replacing components identified by \square make the necessary adjustments indicated. If results do not meet the specified value, change the component identified by \square and repeat the adjustment until the specified value is achieved. (Refer to R525 on pages 17 & 18).
- When replacing parts in the table below be sure to perform the related adjustment.

Part replaced (□)	Adjustment (⊠)
IC301, IC502, IC601, D605, D506, D507, D510, DY, C503, C511, C513, C528, R511, R519, R520, R523, R525, R527, R559, R560, R617, R618, T504 (FBT)	HV Hold-Down (R525)
IC001, IC601, R030, R617, R618, R629, R630, R651, R652, R654, R655, R656	B+ Voltage Confirmation

- All voltages are in V.
- Voltage is dc with respect to ground unless otherwise noted.
- Readings are taken with a 10M Ω digital multimeter.
- Readings are taken with a color-bar signal input.
- Voltage variations may be noted due to normal production tolerance.
- Circled numbers are waveform references.

- : B+ Line
- : B- Line
- : signal path

Reference Information

RESISTOR : RN	METAL FILM
: RC	SOLID
: FPRD	NON FLAMMABLE CARBON
: FUSE	NON FLAMMABLE FUSIBLE
: RW	NON FLAMMABLE WIREWOUND
: RS	NON FLAMMABLE MET AL OXIDE
: RB	NON FLAMMABLE CEMENT
: X	ADJUSTMENT RESISTOR
COIL : LF-8L	MICRO INDUCTOR
CAPACITOR : TA	TANTALUM
: PS	STYROL
: PP	POLYPROPYLENE
: PT	MYLAR
: MPS	METALIZED POLYESTER
: MPP	METALIZED POLYPROPYLENE
: ALB	BIPOLAR
: ALT	HIGH TEMPERATURE
: ALR	HIGH RIPPLE

Note: The symbol display is on the component side.

The components identified by shading and mark Δ are critical for safety. Replace only with part number specified.

The symbol indicates fast operating fuse. Replace only with fuse of same rating as marked.

A TUNING CONTROL, Y/C/I,
POWER SUPPLY, DEFECTION,
TUNER/IF, AUDIO MTS

- A BOARD -

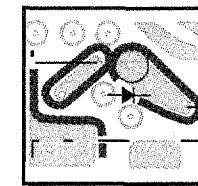
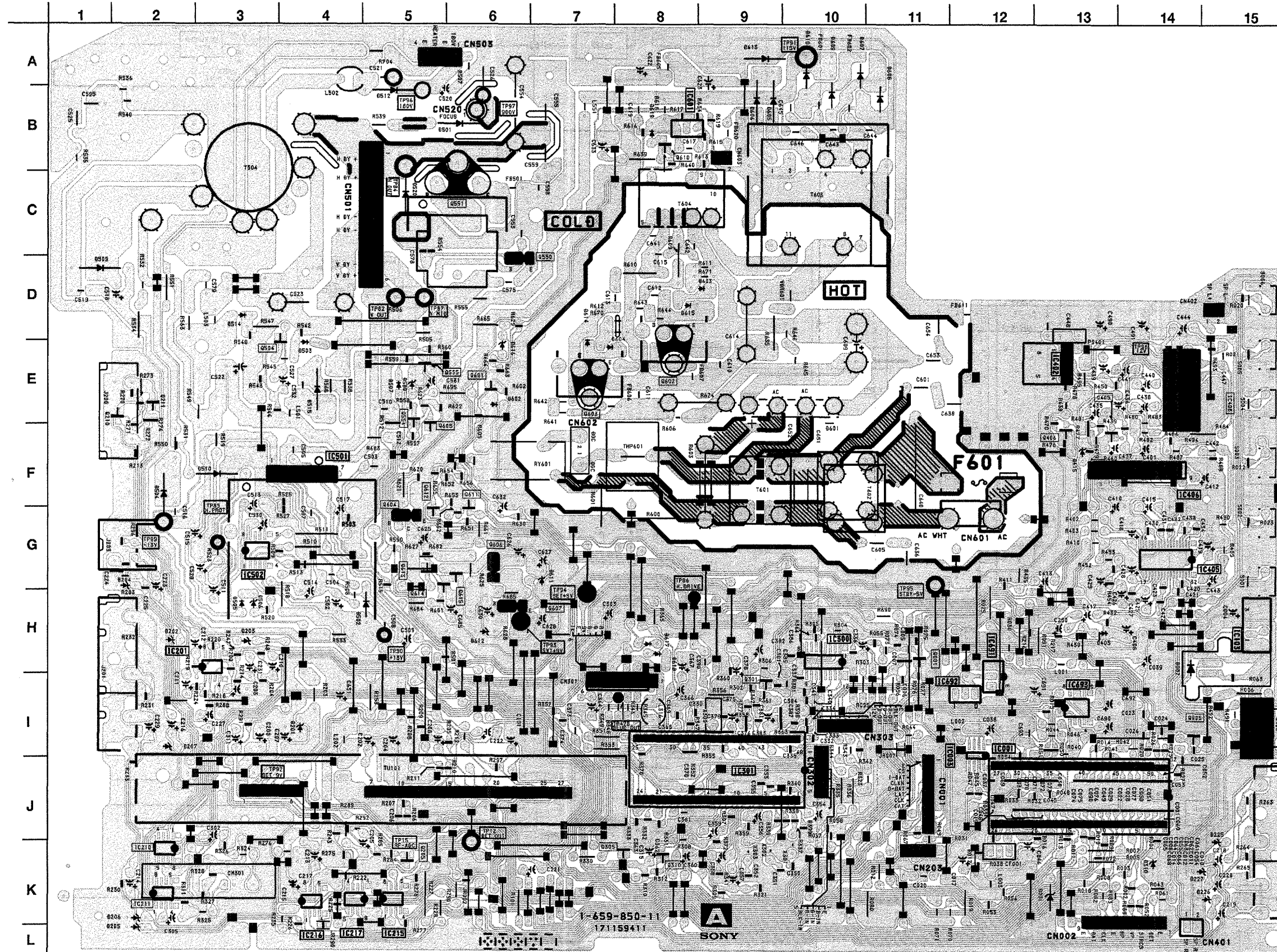

NOTE:

The circuit indicated as left contains high voltage of over 600Vp-p. Care must be taken to prevent an electric shock during inspection or repair in these areas.

IC	DIODE
IC001 I-12	D001 K-13
IC003 I-11	D201 I-4
IC103 H-15	D203 H-3
IC201 H-2	D205 L-2
IC215 K-5	D206 L-2
IC216 K-4	D207 I-2
IC217 K-4	D225 J-15
IC301 J-9	D226 K-14
IC402 E-13	D227 K-14
IC406 F-14	D310 K-14
IC408 E-15	D403 H-13
IC501 F-4	D415 F-13
IC502 G-3	D502 H-4
IC601 B-8	D503 E-4
IC693 I-13	D504 F-2
TRANSISTOR	
Q205 K-5	D505 H-3
Q210 E-1	D506 H-3
Q211 E-2	D507 E-5
Q301 I-9	D509 D-1
Q305 K-7	D510 F-3
Q405 E-13	D512 B-5
Q406 F-13	D514 D-3
Q504 E-3	D515 E-4
Q550 D-6	D601 H-10
Q551 C-5	D602 E-6
Q601 E-6	D603 D-8
Q602 E-8	D604 E-7
Q603 E-7	D605 B-9
Q605 F-5	D606 B-9
Q606 G-6	D607 A-10
Q607 H-7	D608 A-11
Q610 B-8	D609 B-10
Q612 F-5	D610 A-10
Q613 G-5	D611 G-7
Q614 H-5	D612 H-6
Q615 H-6	D613 A-9
	D614 E-7
	D615 D-8
	D619 B-8

A BOARD WAVEFORMS

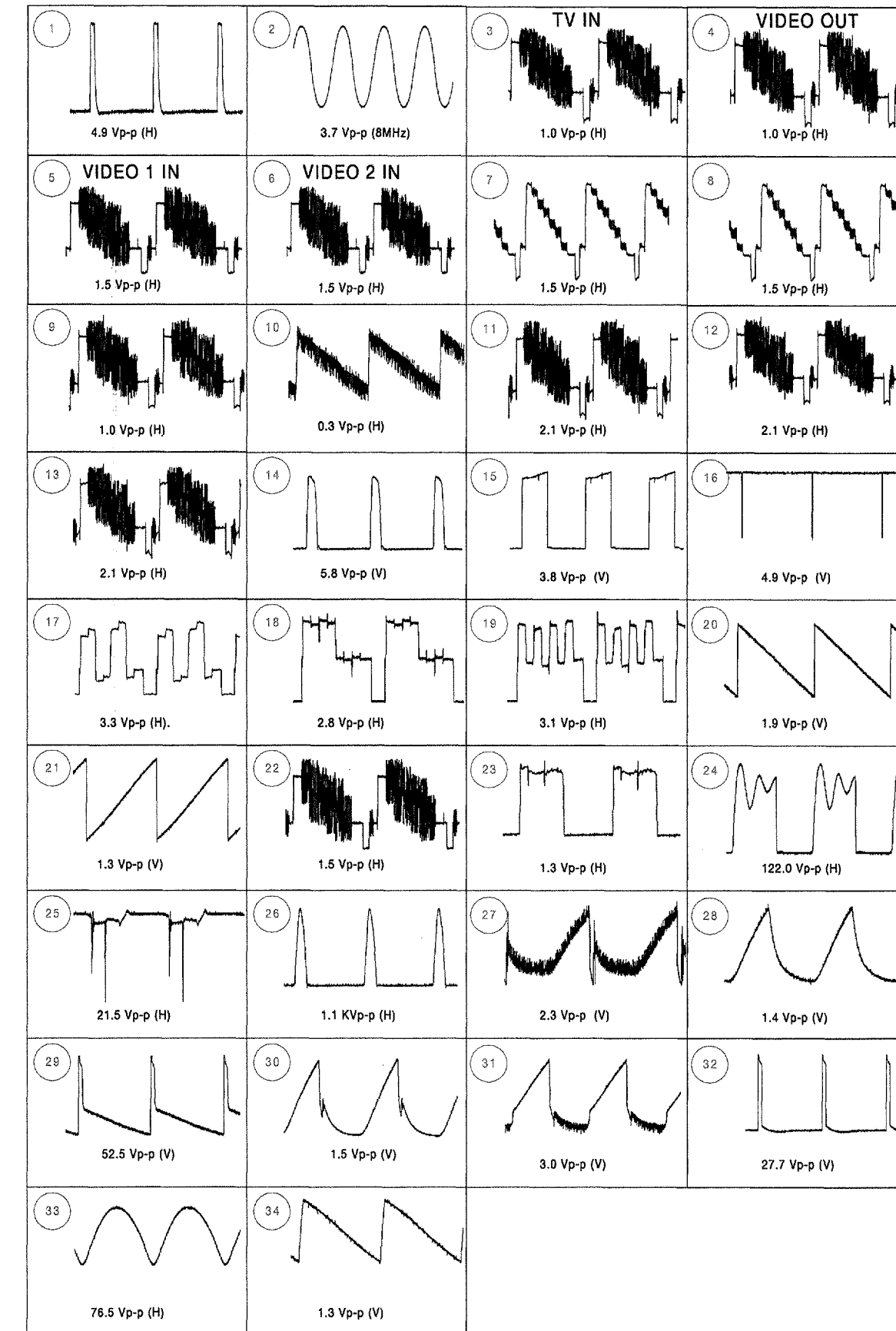

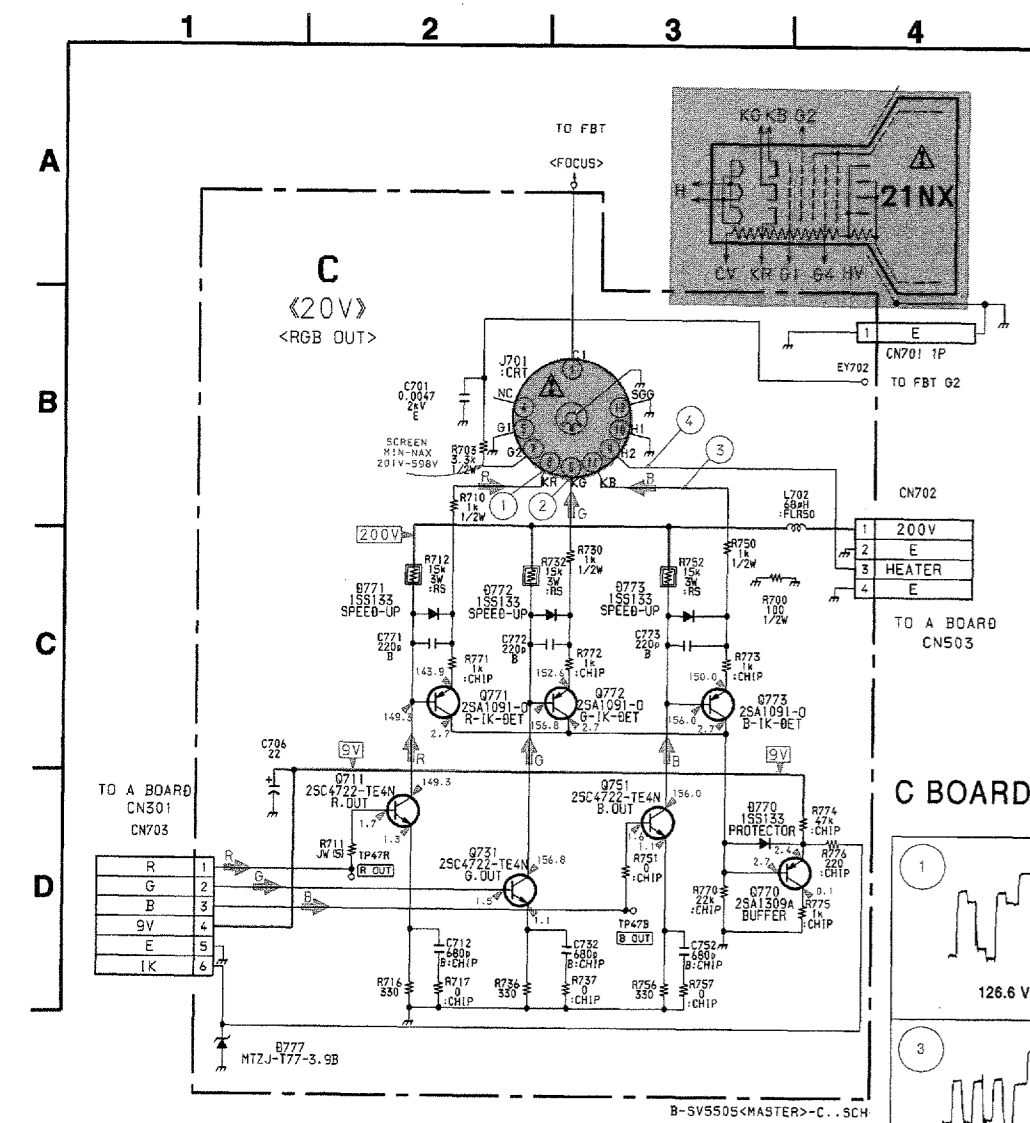

C BOARD WAVEFORMS

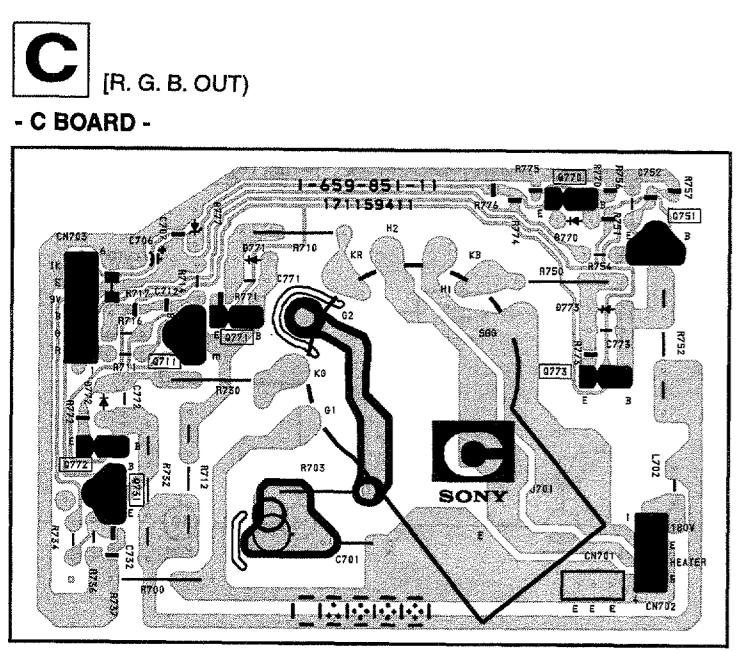
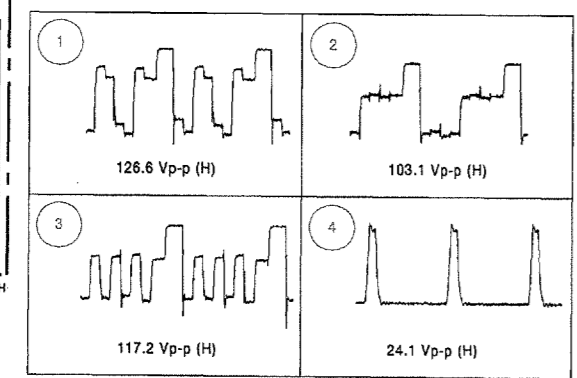

Schematic diagrams
A board

6-4. SEMICONDUCTORS

<p>TDA7267</p> <p>TOP VIEW</p>	<p>LA7830</p>	<p>uPC1093J-1-T</p> <p>CATHODE ANODE</p>	<p>TDA2009A</p>	<p>1SS119-25TD 1SS133T-77 MTZJ-T-77-10B MTZJ-T-77-2.2 MTZJ-T-77-3.3B MTZJ-T-77-30D MTZJ-T-77-5.1C MTZJ-T-77-5.6C MTZJ-T-77-8.2B</p>
<p>D3SB60F</p>	<p>D1N120-TA EL1Z-V1 RGF10GPKG3</p> <p>CATHODE ANODE</p>	<p>GP08DPKG3</p> <p>CATHODE ANODE</p>	<p>D2S4MTA1</p> <p>CATHODE ANODE</p>	<p>2SD1292</p>
<p>NJM2233BM(Te2) NJM2234(Te2) NJM4558M-TE2</p>	<p>2SD2137-OP-TA</p>	<p>2SD1877S-SONY-CA</p>	<p>2SC3209LK-TP 2SD1292</p>	<p>2SA1330-T106 2SB709A-QRS-TX 2SD601A-QRS-TX</p>
<p>2SC5271-ROYG-F</p>	<p>2SA1091-0</p>	<p>2SC2611</p> <p>LETTER SIDE</p>	<p>2SA1175-HFE</p> <p>LETTER SIDE</p>	<p>SBX1790-51</p>
<p>M37267M6 - 059SP</p> <p>TOP VIEW DIP 52PIN</p>	<p>CXA1870S</p> <p>TOP VIEW SDIP 42PIN</p>	<p>uPC1406HA</p>	<p>ST24C01FM6TR</p> <p>(TOP VIEW)</p>	<p>MM1319</p>

SECTION 7
EXPLODED VIEWS

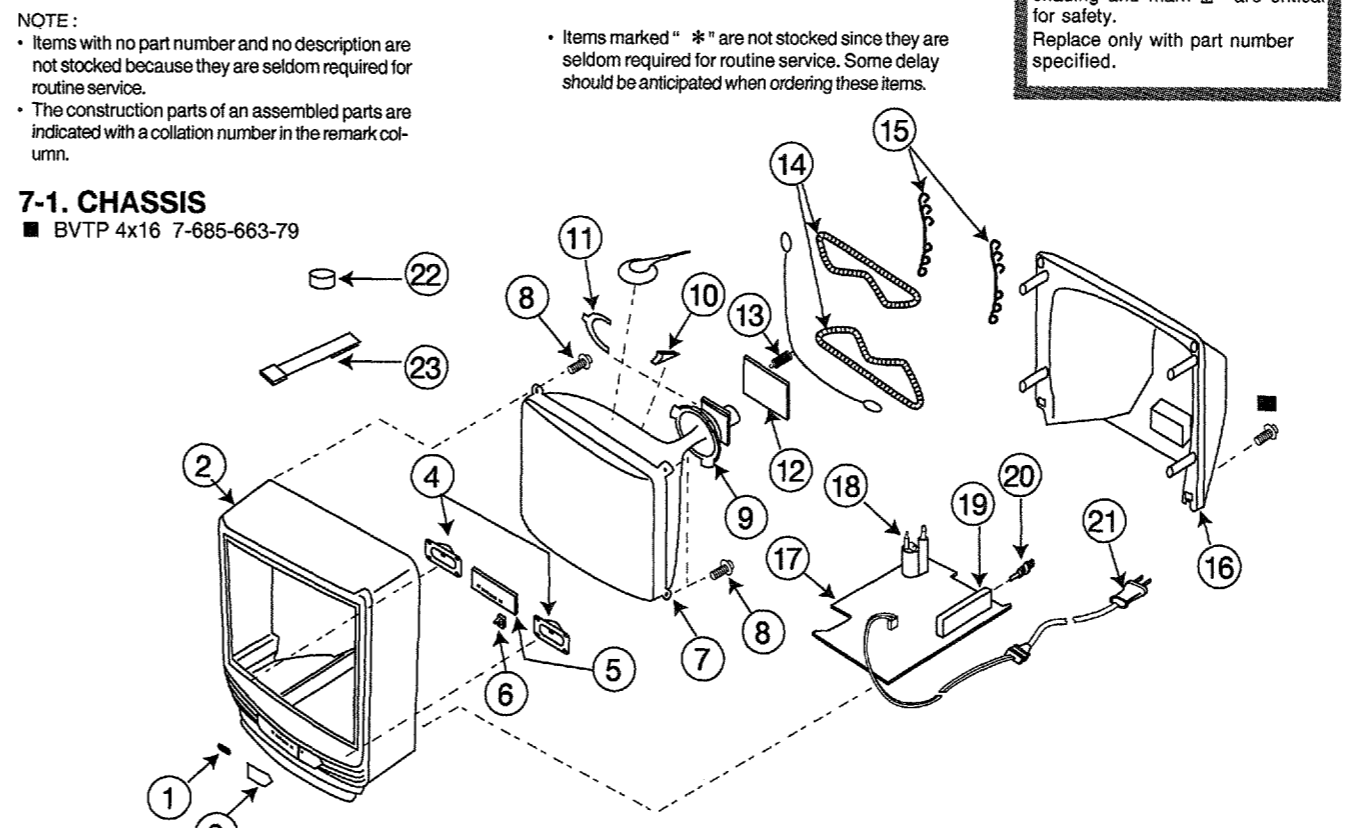

NOTE:
• Items with no part number and no description are not stocked because they are seldom required for routine service.
• The construction parts of an assembled parts are indicated with a collation number in the remark column.

7-1. CHASSIS
■ BVPT 4X16 7-685-663-79

REF.NO.	PART NO.	DESCRIPTION	REMARK
1	4-046-161-01	EMBLEM (NO.8) SONY	
2	4-052-638-01	BEZEL (KV-20S30)	
	4-052-638-21	BEZEL (KV-21R20)	
	4-052-638-41	BEZEL (KV-21RS20)	
	4-052-653-01	BEZEL (KV-20M20/21PM1)	
	4-052-653-11	BEZEL (KV-21RD1)	
	4-052-656-11	BEZEL (KV-20S20/21PS1)	
	4-052-656-31	BEZEL (KV-20S21)	
	4-052-656-41	BEZEL (KV-21SD1)	
3	4-052-641-01	DOOR, CONTROL (KV-21R20/20S20/21RS20/21PS1/20S30)	
	4-052-641-21	DOOR, CONTROL (KV-20M20/21PM1)	
	4-052-641-41	DOOR, CONTROL (KV-20S21)	
	4-052-641-51	DOOR, CONTROL (KV-21RD1)	
	4-052-641-61	DOOR, CONTROL (KV-21SD1)	
4	1-505-265-11	SPEAKER (9X5CM) (KV-20M20/21RD1/21PM1/21R20)	
	1-505-266-11	SPEAKER (9X5CM) (KV-20S20/20S21/21RS20/21SD1/21PS1/21RS20)	
5	4-052-639-01	BUTTON, MULTI	
	4-052-639-11	BUTTON, MULTI (KV-20S21 ONLY)	
6	4-052-640-01	FILTER, REMOTE CRT 21IX (KV-20M20/21R20/21RD1/21PM1/20S20/20S21/21RS20/21SD1/21PS1)	
	4-738-168-05	CRT 21IX (KV-20M20/21R20/21RD1/21PM1/20S20/20S21/21RS20/21SD1/21PS1)	
	4-738-168-05	CRT 21IX (KV-20M20/21R20/21RD1/21PM1/20S20/20S21/21RS20/21SD1/21PS1)	
	4-738-168-05	CRT 21IX (KV-20M20/21R20/21RD1/21PM1/20S20/20S21/21RS20/21SD1/21PS1)	
8	4-738-168-05	CRT 21IX (KV-20M20/21R20/21RD1/21PM1/20S20/20S21/21RS20/21SD1/21PS1)	
9	4-738-168-05	CRT 21IX (KV-20M20/21R20/21RD1/21PM1/20S20/20S21/21RS20/21SD1/21PS1)	
10	4-033-005-01	SPACER, DY	
11	1-452-277-00	MAGNET, BMC	
12	A-1331-518-A	MOUNTED PCB, C	
13	4-375-394-01	SPRING, GROUND	
14	4-099-797-11	COIL, DEGAUSSIFICATION	
15	4-369-319-11	HOLDER, DEGAUSSING COIL	
16	4-052-642-31	REAR COVER (KV-20S21)	
	4-052-643-11	REAR COVER (KV-20S30)	
	4-052-643-31	REAR COVER (KV-21R20/20M20/21PM1/21RD1)	
	4-052-643-41	REAR COVER (KV-21RS20/20S20/21PS1/21SD1)	
17	A-1297-711-A	COMPLETE (PCB, A) (KV-20M20/21R20/21RD1/21PM1)	
	A-1297-712-A	COMPLETE (PCB, A) (KV-20S30)	
	A-1297-782-A	COMPLETE (PCB, A) (KV-20S20/20S21/21RS20/21SD1/21PS1)	
	C024	CERAMIC CHIP 220pF 5% 50V	
18	1-453-211-11	TRANSFORMER ASSY. (FLYBACK/KV1744)	
19	4-598-439-06	TUNER PTP/CA402 (KV-20M20/21RD1/21PM1/21R20)	
	4-598-439-06	TUNER PTP/CA402 (KV-20M20/21RD1/21PM1/21R20)	
	4-598-439-06	TUNER PTP/CA402 (KV-20M20/21RD1/21PM1/21R20)	
20	1-766-374-11	PLUG, P PIN	
21	1-751-057-11	CORD, POWER (WITH CONNECTOR) 10A/125V (KV-20M20/21R20/21RD1/21PM1/20S20/21RS20/21SD1/21PS1/20S30)	
	1-751-058-11	CORD, POWER (WITH CONNECTOR) 10A/125V (KV-20S21)	
22	1-452-032-00	MAGNET, DISC	
23	X-4308-815-0	PERMALLOY ASSY, CONVERGENCE	

SECTION 8
ELECTRICAL PARTS LIST

A
The components identified by shading and mark Δ are critical for safety. Replace only with part number specified.

- Items marked " * " are not stocked since they are seldom required for routine service. Some delay should be anticipated when ordering these items.
 - All variable and adjustable resistors have characteristic curve B, unless otherwise noted.
 - All resistors are in ohms
 - F : nonflammable
- When indicating parts by reference number, please include the board name.
- CAPACITORS
MF : μF, PF : μμF
- COILS
MMH : mH, μH : μH
- RESISTORS
- The components identified by B in this manual have been carefully factory-selected for each set in order to satisfy regulations regarding X-ray radiation. Should replacement be required, replace only with the value originally used.

REF.NO.	PART NO.	DESCRIPTION	REMARK
*	A-1297-711-A	A BOARD, COMPLETE (KV-20M20/21R20/21RD1/21PM1)	
*	A-1297-712-A	A BOARD, COMPLETE (KV-20S30)	
*	A-1297-782-A	A BOARD, COMPLETE (KV-20S20/20S21/21RS20/21SD1/21PS1)	

	1-533-223-11	HOLDER, FUSE	
*	1-900-800-66	CONNECTOR ASSY, 4P MINI MICRO	
*	1-900-800-67	CONNECTOR ASSY, 6P MINI MICRO	
	4-382-954-11	SCREW (M3X10), P, SW (+)	
	4-382-954-11	SCREW (M3X10), P, SW (+)	
	C053	CERAMIC CHIP 100pF 5% 50V	
	C060	CERAMIC CHIP 10pF 0.5pF 50V	
	C101	ELECT 4.7MF 20% 50V	
	C202	ELECT 10MF 20% 50V	
	C203	ELECT 4.7MF 20% 50V (KV-20S30)	
	C204	ELECT 100MF 20% 25V	
	C205	ELECT 4.7MF 20% 50V	
	C206	CERAMIC CHIP 0.0047MF10% 50V	
	C208	ELECT 1MF 20% 50V (KV-20M20/21R20/21RD1/21PM1)	
	C210	ELECT 2.2MF 20% 50V (KV-20S30)	
	C211	ELECT 0.47MF 20% 50V (KV-20S30)	
	C212	ELECT 0.47MF 20% 50V (KV-20S30)	
	C214	ELECT 1MF 20% 50V (KV-20S20/20S21/21RS20/21SD1/21PS1/20S30)	
	C215	ELECT 10MF 20% 50V	
	C216	ELECT 10MF 20% 50V (KV-20S30)	
	C216	ELECT 0.47MF 20% 50V (KV-20M20/21R20/21RD1/21PM1/20S20/20S21/21RS20/21SD1/21PS1)	
	C218	ELECT 10MF 20% 50V (KV-20S30)	
	C219	ELECT 1MF 20% 50V (KV-20S30)	
	C220	ELECT 1MF 20% 50V (KV-20S30)	
	C221	ELECT 1MF 20% 50V (KV-20S20/20S21/21RS20/21SD1/21PS1/20S30)	
	C014	CERAMIC CHIP 0.1MF 10% 25V	
	C017	ELECT 1MF 20% 50V	
	C019	CERAMIC CHIP 560pF 5% 50V	
	C020	FILM 0.1MF 5% 50V	
	C023	CERAMIC CHIP 220pF 5% 50V	
	C024	CERAMIC CHIP 220pF 5% 50V	
	C025	CERAMIC CHIP 220pF 5% 50V	
	C026	CERAMIC CHIP 47pF 5% 50V	
	C028	CERAMIC CHIP 470pF 10% 50V	
	C030	CERAMIC CHIP 220pF 5% 50V	
	C034	CERAMIC CHIP 0.022MF 10% 50V	
	C037	CERAMIC CHIP 0.0022MF 10% 50V	
	C038	ELECT 470MF 20% 25V	
	C046	ELECT 47MF 20% 25V	
	C047	CERAMIC CHIP 220pF 5% 50V	
	C048	CERAMIC CHIP 0.001MF 10% 50V	
	C050	CERAMIC CHIP 100pF 5% 50V	
	C051	CERAMIC CHIP 100pF 5% 50V	
	C052	CERAMIC CHIP 100pF 5% 50V	
	C301	CERAMIC CHIP 100pF 5% 50V	
	C303	ELECT 1000MF 20% 25V	
	C315	ELECT 47MF 20% 25V	
	C330	CERAMIC CHIP 680pF 10% 50V	
	C352	CERAMIC CHIP 12pF 5% 50V	
	C353	CERAMIC CHIP 470pF 10% 50V	
	C354	ELECT 0.47MF 20% 50V	
	C355	CERAMIC CHIP 0.01MF 10% 50V	
	C356	ELECT 220MF 20% 16V	
	C357	ELECT 0.22MF 20% 50V (KV-20S30)	
	C358	ELECT 0.47MF 20% 50V	

The components identified by shading and mark **Δ** are critical for safety. Replace only with part number specified.



REF.NO.	PART NO.	DESCRIPTION	REMARK	REF.NO.	PART NO.	DESCRIPTION	REMARK
C359	1-124-902-00	ELECT 0.47MF 20% 50V		C491	1-126-942-61	ELECT 470MF 20% 25V (KV-20M20/21R20/21RD1/21PM1)	
C360	1-126-963-11	ELECT 4.7MF 20% 50V		C502	1-126-965-11	ELECT 22MF 20% 50V	
C361	1-137-399-11	FILM 0.1MF 5% 50V		C503	1-107-698-11	ELECT 10MF 20% 25V	
C362	1-137-399-11	FILM 0.1MF 5% 50V		C504	1-130-489-00	FILM 0.033MF 5% 50V	
C363	1-137-399-11	FILM 0.1MF 5% 50V		C505	1-102-963-00	CERAMIC 33pF 5% 50V	
C364	1-124-902-00	ELECT 0.47MF 20% 50V		C507	1-102-038-00	CERAMIC 0.001MF 500V	
C366	1-124-903-11	ELECT 1MF 20% 50V		C508	1-102-038-00	CERAMIC 0.001MF 500V	
C367	1-126-963-11	ELECT 4.7MF 20% 50V		C509	1-126-968-11	ELECT 100MF 20% 50V	
C368	1-136-169-00	FILM 0.22MF 5% 50V		C510	1-108-702-11	MYLAR 0.068MF 10% 100V	
C369	1-164-004-11	CERAMIC CHIP 0.22MF 10% 25V		C511 Δ 1-126-963-11	ELECT 4.7MF 20% 50V		
C373	1-137-370-11	FILM 0.01MF 5% 50V		C512	1-163-031-11	CERAMIC CHIP 0.01MF 50V	
C374	1-163-125-00	CERAMIC CHIP 220pF 5% 50V		C513	1-126-964-11	ELECT 10MF 20% 50V	
C375	1-126-963-11	ELECT 4.7MF 20% 50V		C514	1-104-664-11	ELECT 47MF 20% 25V	
C376	1-164-232-11	CERAMIC CHIP 0.01MF 10% 50V		C515	1-126-941-11	ELECT 470MF 20% 25V	
C378	1-124-925-11	ELECT 2.2MF 20% 50V		C516	1-102-244-00	CERAMIC 220pF 10% 500V	
C379	1-164-232-11	CERAMIC CHIP 0.01MF 10% 50V		C517	1-126-941-11	ELECT 470MF 20% 25V	
C381	1-124-903-11	ELECT 1MF 20% 50V		C518	1-126-941-11	ELECT 470MF 20% 25V	
C382	1-104-665-11	ELECT 100MF 20% 25V		C519	1-102-244-00	CERAMIC 220pF 10% 500V	
C383	1-163-017-00	CERAMIC CHIP 0.0047MF 10% 50V		C520	1-107-652-11	ELECT 10MF 20% 250V	
C390	1-137-399-11	FILM 0.1MF 5% 50V		C521	1-102-244-00	CERAMIC 220pF 10% 500V	
C408	1-126-964-11	ELECT 0.47MF 20% 50V (KV-20M20//21R20/21RD1/21PM1)		C522	1-123-024-21	ELECT 33MF 160V	
C408	1-126-964-11	ELECT 10MF 20% 50V (KV-20S20/20S21/21RS20/21SD1/21PS1/20S30)		C523	1-136-105-00	FILM 0.33MF 5% 200V	
	< C410 - C435 LOCATED ON > <KV-20S20/20S21/21RS20/21SD1/21PS1/20S30>			C525	1-106-387-00	MYLAR 0.068MF 10% 200V	
C410	1-126-964-11	ELECT 10MF 20% 50V		C527	1-126-965-11	ELECT 22MF 20% 50V	
C412	1-126-964-11	ELECT 10MF 20% 50V		C528 Δ 1-107-635-11	ELECT 4.7MF 20% 160V		
C413	1-126-964-11	ELECT 10MF 20% 50V		C530	1-104-664-11	ELECT 47MF 20% 25V	
C435	1-124-925-11	ELECT 2.2MF 20% 50V		C553	1-102-228-00	CERAMIC 470pF 10% 500V	
C436	1-126-956-91	ELECT 0.1MF 20% 50V (KV-20M20/21R20/21RD1/21PM1)		C554 Δ 1-106-891-11	FILM 0.005MF 5% 200V		
C437	1-124-925-11	ELECT 2.2MF 20% 50V (KV-20S20/20S21/21RS20/21SD1/21PS1/20S30)		C555 Δ 1-102-115-00	CERAMIC 33pF 10% 2KV		
C438	1-126-933-11	ELECT 100MF 20% 16V (KV-20S20/20S21/21RS20/21SD1/21PS1/20S30)		C558	1-106-371-00	MYLAR 0.015MF 10% 100V	
C439	1-126-965-11	ELECT 22MF 20% 50V		C559 Δ 1-102-115-00	CERAMIC 33pF 10% 2KV		
	< C440 - C443 LOCATED ON > <KV-20S20/20S21/21RS20/21SD1/21PS1/20S30>			C575	1-106-371-00	MYLAR 0.015MF 200V	
C440	1-126-933-11	ELECT 100MF 20% 16V		C579	1-106-367-00	MYLAR 0.01MF 10% 200V	
C441	1-124-925-11	ELECT 2.2MF 20% 50V		C600 Δ 1-113-920-11	ELECT 0.0022MF 20% 250V		
C442	1-136-169-00	FILM 0.22MF 5% 50V		C602 Δ 1-113-920-11	ELECT 0.0022MF 20% 250V		
C443	1-126-941-11	ELECT 470MF 20% 25V		C609	1-104-759-11	ELECT 470MF 20% 200V	
C444	1-126-941-11	ELECT 470MF 20% 25V		C610	1-164-625-11	CERAMIC 680pF 10% 500V	
C447	1-136-169-00	FILM 0.22MF 5% 50V (KV-20S20/20S21/21RS20/21SD1/21PS1/20S30)		C611	1-164-625-11	CERAMIC 680pF 10% 500V	
C448	1-136-173-00	FILM 0.47MF 5% 50V		C612	1-136-171-00	FILM 0.33MF 5% 50V	
C490	1-126-941-11	ELECT 470MF 20% 25V		C613	1-136-171-00	FILM 0.33MF 5% 50V	
C491	1-126-942-61	ELECT 1000MF 20% 25V (KV-20S20/20S21/21RS20/21SD1/21PS1/20S30)		C614	1-136-759-11	FILM 0.039MF 5% 630V	
				C615	1-164-735-11	CAPACITOR 0.0015MF 10% 500V	
				C617	1-137-367-11	FILM 0.0033MF 5% 50V	
				C619	1-106-355-12	MYLAR 0.0033MF 10% 200V	
				C622	1-126-942-61	ELECT 1000MF 20% 25V	
				C623	1-123-024-21	ELECT 33MF 160V	
				C625	1-104-665-11	ELECT 100MF 20% 25V	
				C628	1-104-664-11	ELECT 47MF 20% 25V	
				C631	1-104-664-11	ELECT 47MF 20% 25V	
				C632	1-124-902-00	ELECT 0.47MF 20% 50V	
				C633	1-124-925-11	ELECT 2.2MF 20% 50V	
				C634 Δ 1-113-920-11	ELECT 0.0022MF 20% 250V		
				C638 Δ 1-113-920-11	ELECT 0.0022MF 20% 250V		

A

The components identified by shading and mark **A** are critical for safety. Replace only with part number specified.

REF.NO.	PART NO.	DESCRIPTION	REMARK
C640	A 1-136-311-11	FILM 0.47MF 20% 125V	
C641	1-136-167-00	FILM 0.15MF 5% 50V	
C642	1-136-167-00	FILM 0.15MF 5% 50V	
C643	1-165-127-11	CERAMIC 470pF 10% 500V	
C644	1-165-127-11	CERAMIC 470pF 10% 500V	
C645	1-165-127-11	CERAMIC 470pF 10% 500V	
C646	1-165-127-11	CERAMIC 470pF 10% 500V	
C653	1-113-910-11	ELECT 470pF 10% 250V	
C685	1-124-903-11	ELECT 1MF 20% 50V	
C690	1-124-902-00	ELECT 0.47MF 20% 50V	
C691	1-126-941-11	ELECT 470MF 20% 25V	
C692	1-104-664-11	ELECT 47MF 20% 25V	
C693	1-136-173-00	FILM 0.47MF 5% 50V	
<FILTER>			
CF001	1-579-952-21	VIBRATOR, CERAMIC	
<CONNECTOR>			
CN203	* 1-560-124-00	PLUG, CONNECTOR (2.5MM) 4P	
CN301	1-900-800-67	CONNECTOR ASSY, 6P MINI MICRO	
CN401	1-564-505-11	PLUG, CONNECTOR 2P (KV-20S20/20S21/21RS20/21SD1/21PS1/20S30)	
CN402	1-564-505-11	PLUG, CONNECTOR 2P	
CN501	* 1-580-798-11	CONNECTOR PIN (DY) 6P	
CN503	1-900-800-66	CONNECTOR ASSY, 4P MINI MICRO	
CN601	* 1-580-843-11	PIN, CONNECTOR (POWER)	
CN602	1-508-786-00	PIN, CONNECTOR (5MM PITCH) 2P	
<DIODE>			
D001	8-719-921-44	DIODE MTZJ-T-77-5.1C	
D201	8-719-982-22	DIODE MTZJ-T-77-30D	
D203	8-719-109-66	DIODE MTZJ-T-77-3.3B (KV-20S30)	
D205	8-719-110-17	DIODE MTZJ-T-77-10B	
D206	8-719-110-17	DIODE MTZJ-T-77-10B (KV-20S20/20S21/21RS20/21SD1/21PS1/20S30)	
D207	8-719-110-17	DIODE MTZJ-T-77-10B	
D225	8-719-110-17	DIODE MTZJ-T-77-10B (KV-20S30)	
D226	8-719-110-17	DIODE MTZJ-T-77-10B (KV-20S30)	
D227	8-719-110-17	DIODE MTZJ-T-77-10B (KV-20S30)	
D310	8-719-921-44	DIODE MTZJ-T-77-5.1C	
D403	8-719-991-33	DIODE 1SS133T-77	
D415	8-719-982-96	DIODE MTZJ-T-77-2.2A (KV-20M20/21R20/21RD1/21PM1)	
D502	8-719-908-03	DIODE GP08DPKG3	
D503	8-719-991-33	DIODE 1SS133T-77	
D504	8-719-302-43	DIODE RGP10GPKG3	
D505	8-719-991-33	DIODE 1SS133T-77	
D506	8-719-110-08	DIODE MTZJ-T-77-8.2B	
D507	8-719-991-33	DIODE 1SS133T-77	
D509	8-719-302-43	DIODE RGP10GPKG3	
D510	A 8-719-302-43	DIODE EL12-V1	
D512	8-719-302-43	DIODE RGP10GPKG3	

REF.NO.	PART NO.	DESCRIPTION	REMARK
D514	8-719-991-33	DIODE 1SS133T-77	
D515	8-719-302-43	DIODE RGP10GPKG3	
D601	A 8-719-510-51	DIODE DSB60F	
D602	8-719-991-33	DIODE 1SS133T-77	
D603	8-719-911-19	DIODE 1SS119-25TD	
D604	8-719-911-19	DIODE 1SS119-25TD	
D605	8-719-022-97	DIODE D2S4MTA1	
D606	8-719-022-97	DIODE D2S4MTA1	
D607	8-719-510-26	DIODE D1NL20-TA	
D608	8-719-510-26	DIODE D1NL20-TA	
D609	8-719-510-26	DIODE D1NL20-TA	
D610	8-719-510-26	DIODE D1NL20-TA	
D611	8-719-110-17	DIODE MTZJ-T-77-10B	
D612	8-719-109-89	DIODE MTZJ-T-77-5.6C	
D613	8-719-057-53	DIODE EZ0150V1	
D614	8-719-911-19	DIODE 1SS119-25TD	
D615	8-719-911-19	DIODE 1SS119-25TD	
D619	8-719-911-19	DIODE 1SS119-25TD	
<FUSE>			
F601	A 1-576-193-11	FUSE 6.3A/125V	
<FERRITE BEAD>			
FB501	1-410-396-41	FERRITE BEAD INDUCTOR 0.45UH	
FB601	1-412-911-11	INDUCTOR, FERRITE BEAD	
FB602	1-412-911-11	INDUCTOR, FERRITE BEAD	
FB605	1-410-396-41	FERRITE BEAD INDUCTOR 0.45UH	
FB606	1-410-396-41	FERRITE BEAD INDUCTOR 0.45UH	
FB607	1-410-396-41	FERRITE BEAD INDUCTOR 0.45UH	
FB611	1-412-911-11	INDUCTOR, FERRITE BEAD	
<IC>			
IC001	8-759-390-31	IC M37267M6-059SP	
IC003	8-759-354-27	IC ST24C01FM6TR	
IC103	8-747-905-11	IC SBX1790-51	
IC201	8-759-100-96	IC NJM4558M-TE2 (KV-20S30)	
IC215	8-759-710-07	IC NJM2234M-TE2 (KV-20S30)	
IC215	8-759-710-86	IC NJM2233BM-TE2 (KV-20S20/20S21/21RS20/21SD1/21PS1)	
IC216	8-759-710-07	IC NJM2234M-TE2 (KV-20S30)	
IC216	8-759-710-86	IC NJM2233BM-TE2 (KV-20M20/21R20/21RD1/21PM1/20S20/20S21/21RS20/21SD1/21PS1)	
IC217	8-759-710-07	IC NJM2234M-TE2 (KV-20S30)	
IC301	8-752-070-52	IC CXA1870S	
IC402	8-759-365-39	IC TDA7267 (KV-20M20/21R20/21RD1/21PM1)	
IC406	8-759-145-27	IC UPC1406HA (KV-20S20/20S21/21RS20/21SD1/21PS1/20S30)	
IC408	8-759-980-43	IC TDA2009A (KV-20S20/20S21/21RS20/21SD1/21PS1/20S30)	

The components identified by shading and mark Δ are critical for safety .
Replace only with part number specified.



REF.NO.	PART NO.	DESCRIPTION	REMARK	REF.NO.	PART NO.	DESCRIPTION	REMARK
IC501	8-759-801-98	IC LA7830		Q613	8-729-422-27	TRANSISTOR 2SD601A-QRS-TX	
IC502 Δ	8-759-100-96	IC MM4568M-TE2		Q614	8-729-422-27	TRANSISTOR 2SD601A-QRS-TX	
IC601 Δ	8-759-198-31	IC UPC1093J-1-T		Q615	8-729-422-27	TRANSISTOR 2SD601A-QRS-TX	
IC693	8-759-371-21	IC MM1319					
	<JACK>				<RESISTOR>		
J200	1-580-441-11	JACK, PIN 2P	(KV-20S30)	R001	1-216-065-00	METAL GLAZE 4.7K 5% 1/10W	
J201	1-580-443-11	JACK, PIN 3P		R002	1-216-073-00	METAL GLAZE 10K 5% 1/10W	
		(KV-20S20/20S21/21RS20/21SD1/21PS1/20S30)		R003	1-216-033-00	METAL GLAZE 220 5% 1/10W	
J201	1-580-411-31	JACK, PIN 2P		R005	1-249-429-11	CARBON 10K 5% 1/4W	
		(KV-20M20/21R20/21RD1/21PM1)		R007	1-249-421-11	CARBON 2.2K 5% 1/4W	
J202	1-691-110-11	JACK, PIN 3P	(KV-20S30)	R008	1-216-033-00	METAL GLAZE 220 5% 1/10W	
J400	1-568-267-21	JACK		R009	1-216-033-00	METAL GLAZE 220 5% 1/10W	
	<CHIP CONDUCTOR>			R010	1-216-033-00	METAL GLAZE 220 5% 1/10W	
JR002	1-216-295-91	CONDUCTOR, CHIP	(2012)			(KV-20S20/20S21/21RS20/21SD1/21PS1/20S30)	
JR007	1-216-295-91	CONDUCTOR, CHIP	(2012)	R011	1-216-033-00	METAL GLAZE 220 5% 1/10W	
JR290	1-216-295-91	CONDUCTOR, CHIP	(2012)			(KV-20S20/20S21/21RS20/21SD1/21PS1/20S30)	
	<COIL>			R012	1-247-815-91	CARBON 220 5% 1/4W	
L001	1-410-470-11	INDUCTOR 10UH		R013	1-216-081-00	METAL GLAZE 22K 5% 1/10W	
L002	1-408-421-00	INDUCTOR 100UH		R014	1-216-033-00	METAL GLAZE 220 5% 1/10W	
L003	1-408-421-00	INDUCTOR 100UH		R015	1-216-033-00	METAL GLAZE 220 5% 1/10W	
L202	1-410-470-11	INDUCTOR 10UH		R016	1-216-041-00	METAL GLAZE 470 5% 1/10W	
L316	1-410-671-31	INDUCTOR 47UH		R017	1-216-113-00	METAL GLAZE 470K 5% 1/10W	
L501	1-412-553-11	INDUCTOR 3.3MMH		R018	1-216-049-91	METAL GLAZE 1K 5% 1/10W	
L502	1-410-669-31	INDUCTOR 33UH		R019	1-249-425-11	CARBON 4.7K 5% 1/4W	
L503 Δ	1-412-531-31	INDUCTOR 33UH		R020	1-216-069-00	METAL GLAZE 6.8K 5% 1/10W	
L551	1-412-533-21	INDUCTOR 47UH		R021	1-216-045-00	METAL GLAZE 680 5% 1/10W	
	<IC LINK>			R022	1-216-047-91	METAL GLAZE 820 5% 1/10W	
PS101 Δ	1-532-637-00	LINK, IC		R023	1-216-057-00	METAL GLAZE 2.2K 5% 1/10W	
		(KV-20S20/20S21/21RS20/21SD1/21PS1/20S30)		R025	1-216-033-00	METAL GLAZE 220 5% 1/10W	
				R026	1-216-033-00	METAL GLAZE 220 5% 1/10W	
				R027	1-216-033-00	METAL GLAZE 220 5% 1/10W	
	<TRANSISTOR>			R028	1-216-041-00	METAL GLAZE 470 5% 1/10W	
Q205	8-729-422-27	TRANSISTOR 2SD601A-QRS-TX		R029	1-249-431-11	CARBON 15K 5% 1/4W	
Q210	8-729-422-27	TRANSISTOR 2SD601A-QRS-TX	(KV-20S30)	R030	1-249-429-11	CARBON 10K 5% 1/4W	
Q211	8-729-422-27	TRANSISTOR 2SD601A-QRS-TX	(KV-20S30)	R031	1-216-045-00	METAL GLAZE 680 5% 1/10W	
Q301	8-729-216-22	TRANSISTOR 2SB709A-QRS-TX		R032	1-216-033-00	METAL GLAZE 220 5% 1/10W	
Q305	8-729-216-22	TRANSISTOR 2SB709A-QRS-TX		R033	1-216-033-00	METAL GLAZE 220 5% 1/10W	
Q405	8-729-216-22	TRANSISTOR 2SB709A-QRS-TX		R038	1-216-049-91	METAL GLAZE 1K 5% 1/10W	
		(KV-20S20/20S21/21RS20/21SD1/21PS1/20S30)		R039	1-216-077-00	METAL GLAZE 15K 5% 1/10W	
Q406	8-729-422-27	TRANSISTOR 2SD601A-QRS-TX		R041	1-216-295-91	CONDUCTOR, CHIP (2012)	
		(KV-20M20/21R20/21RD1/21PM1)				(KV-20S20/20S21/21RS20/21SD1/21PS1/20S30)	
Q504	8-729-105-08	TRANSISTOR 2SA1330-T106		R042	1-249-425-11	CARBON 4.7K 5% 1/4W	
Q550	8-729-140-96	TRANSISTOR 2SC3209LK-TP				(KV-20M20/21R20/21RD1/21PM1)	
Q551	8-729-810-49	TRANSISTOR 2SD1877S-SONY-CA		R043	1-249-417-11	CARBON 1K 5% 1/4W	
Q601	8-729-422-27	TRANSISTOR 2SD601A-QRS-TX		R044	1-247-815-91	CARBON 220 5% 1/4W	
Q602	8-729-035-37	TRANSISTOR 2SC5271-ROYG-F		R045	1-216-065-00	METAL GLAZE 4.7K 5% 1/10W	
Q603	8-729-035-37	TRANSISTOR 2SC5271-ROYG-F		R046	1-247-815-91	CARBON 220 5% 1/4W	
Q605	8-729-422-27	TRANSISTOR 2SD601A-QRS-TX		R047	1-216-065-00	METAL GLAZE 4.7K 5% 1/10W	
Q606	8-729-423-99	TRANSISTOR 2SD2137-OP-TA		R048	1-216-025-91	METAL GLAZE 100 5% 1/10W	
Q607	8-729-111-55	TRANSISTOR 2SD1292		R049	1-216-089-91	METAL GLAZE 47K 5% 1/10W	
Q610	8-729-216-22	TRANSISTOR 2SB709A-QRS-TX		R050	1-216-073-00	METAL GLAZE 10K 5% 1/10W	
Q612	8-729-422-27	TRANSISTOR 2SD601A-QRS-TX		R051	1-216-033-00	METAL GLAZE 220 5% 1/10W	
						(KV-20S20/20S21/21RS20/21SD1/21PS1/20S30)	



The components identified by shading and mark **△** are critical for safety .
 Replace only with part number specified.

REF.NO.	PART NO.	DESCRIPTION	REMARK
R054	1-216-073-00	METAL GLAZE 10K 5%	1/10W
R055	1-216-033-00	METAL GLAZE 220 5%	1/10W
R056	1-216-065-00	METAL GLAZE 4.7K 5%	1/10W
R057	1-216-065-00	METAL GLAZE 4.7K 5%	1/10W
R058	1-216-065-00	METAL GLAZE 4.7K 5%	1/10W
R070	1-249-425-11	CARBON 4.7K 5%	1/4W (KV-20S20/20S21/21RS20/21SD1/21PS1/20S30)
R071	1-249-425-11	CARBON 4.7K 5%	1/4W (KV-20S20/20S21/21RS20/21SD1/21PS1/20S30)
R072	1-216-033-00	METAL GLAZE 220 5%	1/10W (KV-20S30)
R101	1-249-429-11	CARBON 10K 5%	1/4W
R200	1-216-069-00	METAL GLAZE 6.8K 5%	1/10W (KV-20S30)
R203	1-215-899-11	METAL OXIDE 15K 5%	2W F
R204	1-216-097-91	METAL GLAZE 100K 5%	1/10W (KV-20S30)
R206	1-216-689-11	METAL GLAZE 39K 5%	1/10W
R207	1-216-083-00	METAL GLAZE 27K 5%	1/10W
< R208 - R211 LOCATED ON > <(KV-20M20/21R20/21RD1/21PM1)>			
R208	1-216-065-00	METAL GLAZE 4.7K 5%	1/10W
R209	1-216-069-00	METAL GLAZE 6.8K 5%	1/10W
R210	1-216-033-00	METAL GLAZE 220 5%	1/10W
R211	1-216-049-91	METAL GLAZE 1K 5%	1/10W
R212	1-249-425-11	CARBON 4.7K 5%	1/4W
R213	1-216-113-00	METAL GLAZE 470K 5%	1/10W (KV-20S30)
R214	1-216-097-91	METAL GLAZE 100K 5%	1/10W (KV-20S30)
R216	1-216-069-00	METAL GLAZE 6.8K 5%	1/10W (KV-20S20/20S21/21RS20/21SD1/21PS1/20S30)
R217	1-216-065-00	METAL GLAZE 4.7K 5%	1/10W (KV-20S20/20S21/21RS20/21SD1/21PS1/20S30)
< R218 - R222 LOCATED ON KV-20S30>			
R218	1-216-089-91	METAL GLAZE 47K 5%	1/10W
R219	1-216-049-91	METAL GLAZE 1K 5%	1/10W
R220	1-216-089-91	METAL GLAZE 47K 5%	1/10W
R222	1-216-073-00	METAL GLAZE 10K 5%	1/10W
R223	1-247-807-31	CARBON 100 5%	1/4W
< R224 - R226 LOCATED ON KV-20S30>			
R224	1-216-049-91	METAL GLAZE 1K 5%	1/10W
R225	1-216-295-91	CONDUCTOR, CHIP	(2012)
R226	1-216-295-91	CONDUCTOR, CHIP	(2012)
R231	1-216-113-00	METAL GLAZE 470K 5%	1/10W
R232	1-216-022-00	METAL GLAZE 75 5%	1/10W
R233	1-216-113-00	METAL GLAZE 470K 5%	1/10W (KV-20S20/20S21/21RS20/21SD1/21PS1/20S30)
< R243 - R274 LOCATED ON KV-20S30>			
R243	1-216-295-91	CONDUCTOR, CHIP	(2012)
R247	1-216-097-91	METAL GLAZE 100K 5%	1/10W
R248	1-216-097-91	METAL GLAZE 100K 5%	1/10W
R263	1-216-022-00	METAL GLAZE 75 5%	1/10W
R264	1-216-113-00	METAL GLAZE 470K 5%	1/10W
R265	1-216-113-00	METAL GLAZE 470K 5%	1/10W

REF.NO.	PART NO.	DESCRIPTION	REMARK
R270	1-216-113-00	METAL GLAZE 470K 5%	1/10W
R271	1-216-061-00	METAL GLAZE 3.3K 5%	1/10W
R272	1-216-061-00	METAL GLAZE 3.3K 5%	1/10W
R273	1-216-097-91	METAL GLAZE 100K 5%	1/10W
R274	1-216-097-91	METAL GLAZE 100K 5%	1/10W
R284	1-216-041-00	METAL GLAZE 470 5%	1/10W
R285	1-216-041-00	METAL GLAZE 470 5%	1/10W
R288	1-216-069-00	METAL GLAZE 6.8K 5%	1/10W (KV-20S30)
R290	1-247-807-31	RES, CARBON 100 5%	1/4W (KV-20S30)
R291	1-216-295-91	CONDUCTOR, CHIP	(2012)
R292	1-216-295-91	CONDUCTOR, CHIP	(2012) (KV-20M20/21R20/21RD1/21PM1/20S20/20S21/21RS20/21SD1/21PS1)
R293	1-216-025-91	RES, CHIP 100 5%	1/10W (KV-20S20/20S21/21RS20/21SD1/21PS1/20S30)
R297	1-216-295-91	CONDUCTOR, CHIP	(2012) (KV-20M20/21R20/21RD1/21PM1)
R301	1-249-423-11	CARBON 3.3K 5%	1/4W
R302	1-216-057-00	METAL GLAZE 2.2K 5%	1/10W
R306	1-249-417-11	CARBON 1K 5%	1/4W
R307	1-216-295-91	CONDUCTOR, CHIP	(2012)
R310	1-216-065-00	METAL GLAZE 4.7K 5%	1/10W
R312	1-216-295-91	CONDUCTOR, CHIP	(2012)
R335	1-247-815-91	CARBON 220 5%	1/4W
R336	1-247-815-91	CARBON 220 5%	1/4W
R339	1-216-057-00	METAL GLAZE 2.2K 5%	1/10W
R340	1-216-077-00	METAL GLAZE 15K 5%	1/10W
R341	1-216-113-00	METAL GLAZE 470K 5%	1/10W
R342	1-216-033-00	METAL GLAZE 220 5%	1/10W
R343	1-247-815-91	CARBON 220 5%	1/4W
R344	1-247-815-91	CARBON 220 5%	1/4W
R345	1-247-815-91	CARBON 220 5%	1/4W
R346	1-247-815-91	CARBON 220 5%	1/4W
R347	1-216-045-00	METAL GLAZE 680 5%	1/10W
R348	1-247-815-91	CARBON 220 5%	1/4W
R349	1-247-807-31	CARBON 100 5%	1/4W
R351	1-249-429-11	CARBON 10K 5%	1/4W
R353	1-249-417-11	CARBON 1K 5%	1/4W
R355	1-249-419-00	METAL GLAZE 15K 5%	1/10W
R356	1-249-421-11	CARBON 2.2K 5%	1/4W
R357	1-216-073-00	METAL GLAZE 10K 5%	1/10W
R358	1-216-125-00	METAL GLAZE 1.5M 5%	1/10W
R360	1-216-067-00	METAL GLAZE 5.6K 5%	1/10W
R361	1-216-033-00	METAL GLAZE 220 5%	1/10W
R362	1-216-041-00	METAL GLAZE 470 5%	1/10W
R363	1-216-105-91	METAL GLAZE 220K 5%	1/10W
R365	1-247-419-11	CARBON 1.5K 5%	1/4W
R372	1-216-057-00	METAL GLAZE 2.2K 5%	1/10W
R377	1-216-295-91	CONDUCTOR, CHIP	(2012)
R411	1-216-069-00	METAL GLAZE 6.8K 5%	1/10W (KV-20S20/20S21/21RS20/21SD1/21PS1/20S30)
R430	1-216-089-91	METAL GLAZE 47K 5%	1/10W (KV-20M20/21R20/21RD1/21PM1)

The components identified by shading and mark **Δ** are critical for safety. Replace only with part number specified.



REF.NO.	PART NO.	DESCRIPTION	REMARK	REF.NO.	PART NO.	DESCRIPTION	REMARK
R430	1-216-093-00	METAL GLAZE 68K 5% 1/10W (KV-20S20/20S21/21RS20/21SD1/21PS1/20S30)		R510	1-249-420-11	CARBON 1.8K 5% 1/4W	
R432	1-216-097-91	METAL GLAZE 100K 5% 1/10W (KV-20M20/21R20/21RD1/21PM1)		R511	1-249-429-11	CARBON 10K 5% 1/4W	
R432	1-216-075-00	METAL GLAZE 12K 5% 1/10W (KV-20S20/20S21/21RS20/21SD1/21PS1/20S30)		R512	1-208-806-11	METAL GLAZE 10K 0.50%1/10W	
R435	1-249-425-11	CARBON 4.7K 5% 1/4W (KV-20S20/20S21/21RS20/21SD1/21PS1/20S30)		R513	1-208-773-11	METAL GLAZE 430 0.50%1/10W	
R439	1-216-065-91	CHIP 4.7K 1/10W (KV-20M20/21R20/21RD1/21PM1)		R515	1-208-806-11	METAL GLAZE 10K 0.50%1/10W	
R439	1-216-295-91	CONDUCTOR, CHIP (KV-20S20/20S21/21RS20/21SD1/21PS1/20S30)		R518	1-215-429-00	METAL 2.2K 1% 1/4W	
R450	1-216-049-00	METAL GLAZE 2.2K 5% 1/10W (KV-20M20/21R20/21RD1/21PM1)		R519	1-216-467-11	METAL OXIDE 56K 5% 2W F	
R460	1-216-061-00	METAL GLAZE 3.3K 5% 1/10W (KV-20M20/21R20/21RD1/21PM1)		R520	1-208-777-11	METAL GLAZE 620 0.50%1/10W	
R470	1-216-295-91	CONDUCTOR, CHIP (2012) (KV-20S20/20S21/21RS20/21SD1/21PS1/20S30)		R523	1-215-469-00	METAL 100K 1% 1/4W	
R477	1-216-081-00	METAL GLAZE 22K 5% 1/10W (KV-20S20/20S21/21RS20/21SD1/21PS1/20S30)		Δ R525	METAL GLAZE 0.50%1/10W		
R479	1-216-081-00	METAL GLAZE 22K 5% 1/10W (KV-20S20/20S21/21RS20/21SD1/21PS1/20S30)		R527	1-208-806-11	METAL GLAZE 10K 0.50%1/10W	
R480	1-216-057-00	METAL GLAZE 2.2K 5% 1/10W (KV-20M20/21R20/21RD1/21PM1)		R531	1-216-349-00	METAL OXIDE 1 5% 1W F	
	< R481 - R489 LOCATED ON > <KV-20S20/20S21/21RS20/21SD1/21PS1/20S30>			R532	1-215-457-00	METAL 33K 1% 1/4W	
R481	1-216-041-00	METAL GLAZE 470 5% 1/10W		R533	1-216-355-11	METAL OXIDE 3.3 5% 1W F	
R482	1-249-429-11	CARBON 10K 5% 1/4W		R534	1-215-457-00	METAL 33K 1% 1/4W	
R483	1-249-429-11	CARBON 10K 5% 1/4W		R536	1-215-437-00	METAL 4.7K 1% 1/4W	
R484	1-216-013-00	METAL GLAZE 33 5% 1/10W		R538	1-215-864-00	METAL OXIDE 150 5% 1W F	
R486	1-216-013-00	METAL GLAZE 33 5% 1/10W		R540	1-249-441-11	CARBON 100K 5% 1/4W	
R487	1-249-417-11	CARBON 1K 5% 1/4W		R542	1-216-093-00	METAL GLAZE 68K 5% 1/10W	
R488	1-216-298-00	METAL GLAZE 2.2 5% 1/10W		R543	1-208-842-11	METAL GLAZE 330K 0.50%1/10W	
R489	1-249-417-11	CARBON 1K 5% 1/4W		R544	1-208-787-11	METAL GLAZE 1.6K 0.50%1/10W	
R490	1-249-417-11	CARBON 1K 5% 1/4W		R545	1-249-441-11	CARBON 100K 5% 1/4W	
R491	1-249-411-11	CARBON 330 5% 1/4W		R547	1-249-429-11	CARBON 10K 5% 1/4W	
R492	1-249-411-11	CARBON 330 5% 1/4W		R548	1-216-113-00	METAL GLAZE 470K 5% 1/10W	
R493	1-216-298-00	METAL GLAZE 2.2 5% 1/10W (KV-20S20/20S21/21RS20/21SD1/21PS1/20S30)		R549	1-216-369-00	METAL OXIDE 1 5% 2W F	
R494	1-249-417-11	CARBON 1K 5% 1/4W (KV-20S20/20S21/21RS20/21SD1/21PS1/20S30)		R550	1-216-295-91	CONDUCTOR, CHIP (2012)	
R495	1-216-349-00	METAL OXIDE 1 5% 1W F		R554	1-216-057-00	METAL GLAZE 2.2K 5% 1/10W	
R501	1-216-073-00	METAL GLAZE 10K 5% 1/10W		R555	1-215-922-11	METAL OXIDE 6.8K 5% 3W F	
R505	1-216-349-00	METAL OXIDE 1 5% 1W F		R559	1-216-089-91	METAL GLAZE 47K 5% 1/10W	
R506	1-216-453-00	METAL OXIDE 270 5% 2W F		R560	1-216-097-91	METAL GLAZE 100K 5% 1/10W	
R507	1-247-891-00	CARBON 330K 5% 1/4W		R563	1-215-880-00	METAL OXIDE 10 5% 2W F	
R508	1-249-417-11	CARBON 1K 5% 1/4W		R590	1-216-295-91	CONDUCTOR, CHIP (2012)	
R509	1-216-101-00	METAL GLAZE 150K 5% 1/10W		Δ R601	RES(SURGE RES) 4.7M 5% 1/2W		
				R602	1-216-073-00	METAL GLAZE 10K 5% 1/10W	
				Δ R603	CEMENT 1 5% 10W		
				R605	1-216-057-00	METAL GLAZE 2.2% 5% 1/10W	
				R606	1-260-288-11	CARBON 0.47 5% 1/2W	
				R609	1-216-353-00	METAL OXIDE 2.2 5% 1W F	
				R610	1-216-353-00	METAL OXIDE 2.2 5% 1W F	
				R611	1-249-396-11	CARBON 18 5% 1/4W	
				R612	1-249-396-11	CARBON 18 5% 1/4W	
				R615	1-216-093-00	METAL GLAZE 68K 5% 1/10W	
				R616	1-216-057-00	METAL GLAZE 2.2K 5% 1/10W	
				Δ R617	METAL GLAZE 2.2K 0.50%1/10W		
				Δ R618	METAL 100K 1% 1/4W		
				R619	1-216-001-00	METAL GLAZE 10 5% 1/10W	
				R620	1-216-073-00	METAL GLAZE 10K 5% 1/10W	
				R622	1-216-073-00	METAL GLAZE 10K 5% 1/10W	
				R623	1-216-073-00	METAL GLAZE 10K 5% 1/10W	
				R625	1-216-377-11	METAL OXIDE 4.7 5% 2W F	
				R628	1-249-415-11	CARBON 680 5% 1/4W	
				R629	1-208-806-11	METAL GLAZE 10K 0.50%1/10W	
				R630	1-208-826-11	METAL GLAZE 68K 0.50%1/10W	
				R635	1-212-857-00	RES,FUSIBLE 10 5% 1/4W F	

A C

The components identified by shading and mark **Δ** are critical for safety .
Replace only with part number specified.

REF.NO.	PART.NO.	DESCRIPTION	REMARK
R639	1-249-425-11	CARBON 4.7K 5%	1/4W
R640	1-216-085-00	METAL GLAZE 33K 5%	1/10W
R641	1-247-889-00	CARBON 270K 5%	1/4W
R643	1-247-889-00	CARBON 270K 5%	1/4W
R645	1-247-893-11	CARBON 390K 5%	1/4W
R651 Δ	1-216-089-91	METAL GLAZE 47K 5%	1/10W
R652 Δ	1-216-073-00	METAL GLAZE 10K 5%	1/10W
R653 Δ	1-216-065-00	METAL GLAZE 4.7K 5%	1/10W
R654 Δ	1-216-073-00	METAL GLAZE 10K 5%	1/10W
R655	1-216-085-00	METAL GLAZE 33K 5%	1/10W
R656	1-216-089-91	METAL GLAZE 47K 5%	1/10W
R681	1-216-089-91	METAL GLAZE 47K 5%	1/10W
R682	1-216-073-00	METAL GLAZE 10K 5%	1/10W
R683	1-215-924-00	METAL OXIDE 15K 5%	3W F
R684	1-249-429-11	CARBON 10K 5%	1/4W
R690	1-216-355-11	METAL OXIDE 3.3 5%	1W F
R704	1-216-370-11	METAL OXIDE 1.2 5%	2W F
<RELAY>			
R7601 Δ	1-755-018-11	RELAY	
<SWITCH>			
S001	1-692-431-21	SWITCH, TACTILE	
S002	1-692-431-21	SWITCH, TACTILE	
S003	1-692-431-21	SWITCH, TACTILE	
S004	1-692-431-21	SWITCH, TACTILE	
S005	1-692-431-21	SWITCH, TACTILE	
S006	1-692-431-21	SWITCH, TACTILE	
<TRANSFORMER>			
T504 Δ	8-598-961-00	TRANSFORMER ASSY, FLYBACK	
T551	1-437-195-11	TRANSFORMER, HORIZONTAL DRIVE	
T602 Δ	1-423-895-11	TRANSFORMER, LINE FILTER (LFT)	
T603 Δ	1-423-483-21	TRANSFORMER, CONVERTER (P17)	
T604 Δ	1-427-864-11	TRANSFORMER, CONVERTER (P17)	
<THERMISTOR>			
TRP601 Δ	1-810-597-11	THERMISTOR, POSITIVE	
<TUNER>			
TU101 Δ	8-598-339-00	TUNER BTF-LA402 (KY-20M20/21RD1/21PM1/21R20)	
TU101 Δ	8-598-341-00	TUNER BTF-WA405 (KY-20S20/20S21/21RS20/21SD1/21PS1/20S30)	
<VARISTOR>			
VDR601	1-801-074-41	VARISTOR ERZV10D271	
<CRYSTAL>			
X300	1-577-611-11	OSCILLATOR, CERAMIC	
X303	1-760-190-41	VIBRATOR, CRYSTAL	

REF.NO.	PART.NO.	DESCRIPTION	REMARK
* A-1331-518-A		MOUNTED PCB, C	

1-900-800-64		CONNECTOR ASSY, 1P G2 SCREEN	
<CAPACITOR>			
C701	1-162-114-00	CERAMIC 4700pF	2KV
C706	1-126-965-11	ELECT 22MF	20% 50V
C712	1-163-007-11	CERAMIC CHIP 680pF	10% 50V
C732	1-163-007-11	CERAMIC CHIP 680pF	10% 50V
C752	1-163-007-11	CERAMIC CHIP 680pF	10% 50V
C771	1-102-110-00	CERAMIC 220pF	10% 50V
C772	1-102-110-00	CERAMIC 220pF	10% 50V
C773	1-102-110-00	CERAMIC 220pF	10% 50V
<CONNECTOR>			
CN701	1-695-915-11	TAB (CONTACT)	
CN702	1-900-800-66	CONNECTOR ASSY 4P MINI MICRO	
CN703	1-900-800-67	CONNECTOR ASSY. 6P MINI MICRO	
<DIODE>			
D770	8-719-991-33	DIODE 1SS133T-77	
D771	8-719-991-33	DIODE 1SS133T-77	
D772	8-719-991-33	DIODE 1SS133T-77	
D773	8-719-991-33	DIODE 1SS133T-77	
D777	8-719-109-72	DIODE MTZJ-3.9B	
<JACK>			
J701 Δ	1-251-182-11	SOCKET, CRT	
<COIL>			
L702	1-408-419-00	INDUCTOR 68UH	
<TRANSISTOR>			
Q711	8-729-326-11	TRANSISTOR 2SC4722TE4N	
Q731	8-729-326-11	TRANSISTOR 2SC4722TE4N	
Q751	8-729-326-11	TRANSISTOR 2SC4722TE4N	
Q770	8-729-119-76	TRANSISTOR 2SA1309A-QRSTA	
Q771	8-729-200-17	TRANSISTOR 2SA1091-0	
Q772	8-729-200-17	TRANSISTOR 2SA1091-0	
Q773	8-729-200-17	TRANSISTOR 2SA1091-0	
<RESISTOR>			
R700	1-260-087-11	CARBON 100 5%	1/2W
R703	1-260-105-11	CARBON 3.3K 5%	1/2W
R710	1-260-099-11	CARBON 1K 5%	1/2W
R712	1-215-924-00	METAL OXIDE 15K 5%	3W F
R716	1-249-411-11	CARBON 330 5%	1/4W
R717	1-216-295-91	CONDUCTOR, CHIP	(2012)
R730	1-260-099-11	CARBON 1K 5%	1/2W
R732	1-215-924-00	METAL OXIDE 15K 5%	3W F
R736	1-249-411-11	CARBON 330 5%	1/4W
R737	1-216-295-91	CONDUCTOR, CHIP	(2012)
R750	1-260-099-11	CARBON 1K 5%	1/2W
R751	1-216-295-91	CONDUCTOR, CHIP	(2012)

The components identified by shading and mark Δ are critical for safety. Replace only with part number specified.



REF.NO.	PART NO.	DESCRIPTION	REMARK
R752	1-215-924-00	METAL OXIDE 15K 5% 3W P	
R756	1-249-411-11	CARBON 330 5% 1/4W	
R757	1-216-295-91	CONDUCTOR, CHIP (2012)	
R770	1-216-081-00	METAL GLAZE 22K 5% 1/10W	
R771	1-216-049-91	METAL GLAZE 1K 5% 1/10W	
R772	1-216-049-91	METAL GLAZE 1K 5% 1/10W	
R773	1-216-049-91	METAL GLAZE 1K 5% 1/10W	
R774	1-216-089-91	METAL GLAZE 47K 5% 1/10W	
R775	1-216-049-91	METAL GLAZE 1K 5% 1/10W	
R776	1-216-033-00	METAL GLAZE 220 5% 1/10W	
MISCELLANEOUS *****			
	X-4308-815-0	PERMALLOY ASSY, CONVERGENCE	
Δ	1-409-707-31	COIL, DEMAGNETIZATION	
	1-452-932-00	MAGNET, DISC	
	1-452-277-00	MAGNET, BMC	
	1-505-265-11	SPEAKER (9X5CM) (KV-20M20/21RD1/21PML/21R20)	
	1-505-266-11	SPEAKER (9X5CM) (KV-20S30/20S20/20S21/21SD1/21PS1/21RS20)	
Δ	1-751-057-11	CORD, POWER (WITH CONNECTOR) 10A/125V (KV-20M20/21R20/21RD1/21PML/20S20/21RS20/21SD1/21PS1/20S30)	
Δ	1-751-058-11	CORD, POWER (WITH CONNECTOR) 10A/125V (KV-20S21)	
	1-766-374-11	PLUG, F-PIN	
	4-046-161-01	EMBLEM (NO.8), SONY	
	4-052-639-01	BUTTON, MULTI (KV-20M20/21R20/21RD1/21PML/20S20/21RS20/21SD1/21PS1/20S30)	
	4-052-639-11	BUTTON, MULTI (KV-20S21)	
	4-052-640-01	FILTER, REMOTE	
	4-052-641-01	DOOR, CONTROL (KV-21R20/20S20/21RS20/21PS1/20S30)	
	4-052-641-21	DOOR, CONTROL (KV-20M20/21PML)	
	4-052-641-41	DOOR, CONTROL (KV-20S21)	
	4-052-641-51	DOOR, CONTROL (KV-21RD1)	
	4-052-641-61	DOOR, CONTROL (KV-21SD1)	
*	4-369-319-11	BAND, DEGAUSSING COIL	
*	4-375-394-01	SPRING, TENSION	
Δ	8-451-440-11	DY Y21NXA (VTM)	
Δ	8-738-768-05	CRT 21NX (KV-20M20/21R20/21RD1/21PML/20S30/20S20(US)/20S21/21SD1/21PS1)	
Δ	8-738-781-05	CRT 21NX (KV-20S20(CND)/21RS20)	

REF.NO.	PART NO.	DESCRIPTION	REMARK
ACCESSORIES AND PACKING MATERIALS *****			
	1-417-182-11	CONVERTER (KV-21R20/21RD1/21PML/21RS20/21SD1/21PS1)	
	1-501-730-41	ANTENNA, TELESCOPE (KV-21R20/21RD1/21PML/21RS20/21SD1/21PS1)	
	3-701-627-00	BAG, POLYETHYLENE	
	3-810-814-21	MANUAL, INSTRUCTION (KV-20M20/20S20/20S30/20S21)	
	3-810-814-41	MANUAL, INSTRUCTION (KV-21R20/21RD1/21PML/21RS20/21SD1/21PS1)	
*	4-041-254-01	BAG, PROTECTION	
*	4-052-645-01	CUSHION (LOWER) (ASSY)	
*	4-052-648-01	CUSHION (UPPER) (ASSY)	
*	4-052-651-01	CARTON, INDIVIDUAL (KV-20M20/20S20/20S30/20S21)	
*	4-052-663-01	CARTON, INDIVIDUAL (KV-21R20/21RS20)	
*	4-053-800-01	CARTON, INDIVIDUAL (KV-21RD1/21SD1)	
*	4-053-803-01	CARTON, INDIVIDUAL (KV-21PML/21PS1)	
REMOTE COMMANDER *****			
	1-466-966-31	REMOTE COMMANDER (RM-Y116) BLACK (KV-20M20/21R20/21RD1/21PML/20S20/21RS20/21SD1/21PS1/20S30)	
	1-466-966-41	REMOTE COMMANDER (RM-Y116) WHITE (KV-20S21)	
	9-903-826-11	COVER, BATTERY (FOR RM-Y116) BLACK (KV-20M20/21R20/21RD1/21PML/20S20/21RS20/21SD1/21PS1/20S30)	
	9-903-826-21	COVER, BATTERY (FOR RM-116) WHITE (KV-20S21)	

MEMO

A series of horizontal dotted lines for writing.

MEMO

A series of horizontal dotted lines for writing.

MEMO

MEMO

A series of horizontal dotted lines for writing.

MEMO

A series of horizontal dotted lines for writing.

