

HISTORY INFORMATION FOR THE FOLLOWING MANUAL:

SERVICE MANUAL

BA-6 CHASSIS

<u>MODEL NAME</u>	<u>REMOTE COMMANDER</u>	<u>DESTINATION</u>	<u>CHASSIS NO.</u>
KV-20FS100	RM-Y173	US	SCC-S61A-A
KV-20FS100	RM-Y173	CND	SCC-S59A-A
KV-20FV300	RM-Y180	US	SCC-S61B-A
KV-20FV300	RM-Y180	CND	SCC-S59B-A
KV-21FM100	RM-Y172	LATIN NORTH	SCC-S60E-A
KV-21FM100	RM-Y172	LATIN SOUTH	SCC-S60F-A
KV-21FS100	RM-Y173	LATIN NORTH	SCC-S60A-A
KV-21FS100	RM-Y173	LATIN SOUTH	SCC-S60B-A
KV-21FV300	RM-Y180	LATIN SOUTH	SCC-S60D-A
KV-21FV300	RM-Y180	LATIN NORTH	SCC-S60C-A
KV-24FV300	RM-Y180	US	SCC-S61C-A
KV-24FV300	RM-Y180	CND	SCC-S59C-A
KV-25FV300	RM-Y180	LATIN NORTH	SCC-S60G-A
KV-25FV300	RM-Y180	LATIN SOUTH	SCC-S60H-A

ORIGINAL MANUAL ISSUE DATE: 2/2002

ALL REVISIONS AND UPDATES TO THE ORIGINAL MANUAL ARE APPENDED TO THE END OF THE PDF FILE.

<u>REVISION DATE</u>	<u>REVISION TYPE</u>	<u>SUBJECT</u>
2/2002		No revisions or updates are applicable at this time.
2/2002	Supplement - 1	New A Board Schem. and PWB, New CV Board Schem., New M3 Board Schem., R039, R565, R1761 P/N Correction.

TRINITRON® COLOR TELEVISION
SONY®

SERVICE MANUAL

BA-6 CHASSIS

<u>MODEL NAME</u>	<u>REMOTE COMMANDER</u>	<u>DESTINATION</u>	<u>CHASSIS NO.</u>
KV-20FS100	RM-Y173	US	SCC-S61A-A
KV-20FS100	RM-Y173	CND	SCC-S59A-A
KV-20FV300	RM-Y180	US	SCC-S61B-A
KV-20FV300	RM-Y180	CND	SCC-S59B-A
KV-21FM100	RM-Y172	LATIN NORTH	SCC-S60E-A
KV-21FM100	RM-Y172	LATIN SOUTH	SCC-S60F-A
KV-21FS100	RM-Y173	LATIN NORTH	SCC-S60A-A
KV-21FS100	RM-Y173	LATIN SOUTH	SCC-S60B-A
KV-21FV300	RM-Y180	LATIN SOUTH	SCC-S60D-A
KV-21FV300	RM-Y180	LATIN NORTH	SCC-S60C-A
KV-24FV300	RM-Y180	US	SCC-S61C-A
KV-24FV300	RM-Y180	CND	SCC-S59C-A
KV-25FV300	RM-Y180	LATIN NORTH	SCC-S60G-A
KV-25FV300	RM-Y180	LATIN SOUTH	SCC-S60H-A



KV-24FV300



RM-Y180

TRINITRON® COLOR TELEVISION
SONY®

TABLE OF CONTENTS

SECTION TITLE	PAGE
Specifications.....	4
Warnings and Cautions	5
Safety Check-Out.....	6
Self-Diagnostic Function.....	7
1. Disassembly	
1-1. Rear Cover Removal.....	9
1-2. Chassis Assembly Removal	9
1-3. Service Position	9
1-4. Picture Tube Removal	10
Anode Cap Removal Procedure.....	10
2. Set-Up Adjustments	
2-1. Beam Landing.....	11
2-2. Convergence.....	12
2-3. Focus	13
2-4. Screen (G2)	13
2-5. Method of Setting the Service Adjustment Mode.....	14
2-6. White Balance Adjustments	14
3. Safety Related Adjustments	
3-1. <input checked="" type="checkbox"/> R565 Confirmation Method (HV Hold Down Confirmation) and Readjustments.....	15
3-2. B+ Voltage Confirmation and Adjustment	15
4. Circuit Adjustments	
4-1. Setting the Service Adjustment Mode.....	17
4-2. Memory Write Confirmation Method	17
4-3. Remote Adjustment Buttons and Indicators	17
Adjustment Items	18
4-4. ID Map Table	26
4-5. A Board Adjustments	26
5. Diagrams	
5-1. Circuit Boards Location.....	29
5-2. Printed Wiring Board and Schematic Diagram Information	29
5-3. Block Diagram and Schematics	30
A Board Schematic Diagram	31
CV Board Schematic Diagram	41
HR Board Schematic Diagram	43
M3 Board Schematic Diagram	44
5-4. Semiconductors	46
6. Exploded Views	
6-1. Chassis (KV-21FM100 ONLY).....	47
6-2. Chassis (KV-20FS100/21FS100 ONLY).....	48
6-3. Chassis (KV-20FV300/21FV300 ONLY).....	49
6-4. Chassis (KV-24FV300/25FV300 ONLY).....	50
7. Electrical Parts List	51

SPECIFICATIONS

	KV-21FM100 (N)	KV-21FM100 (S)	KV-21FS100 (S)	KV-20FS100/ 21FS100 (N)
Power requirements	120V, 60Hz	220V, 50/60Hz	220V, 50/60Hz	120V, 60Hz
Number of Inputs/Outputs				
Video ¹⁾	2	2	2	2
S Video ²⁾	0	0	0	0
Y, P _B , P _R ³⁾	0	0	1	1
Audio ⁴⁾	2	2	4	4
Audio Out ⁵⁾	0	0	0	0
Speaker output (W)	3W x 2	3W x 2	5W x 2	5W x 2
Headphones ⁵⁾	1	1	1	1
Power Consumption (W)				
In use (Max)	115W	110W	115W	120W
In Standby	1W	1W	1W	1W
Dimensions(W/H/D)				
mm	592 x 466 x 494 mm	592 x 466 x 494 mm	592 x 466 x 494 mm	592 x 466 x 494 mm
in	23 ^{1/4} x 18 ^{3/8} x 19 ^{1/2}	23 ^{1/4} x 18 ^{3/8} x 19 ^{1/2}	23 ^{1/4} x 18 ^{3/8} x 19 ^{1/2}	23 ^{1/4} x 18 ^{3/8} x 19 ^{1/2}
Mass				
kg	24.8 kg	24.8 kg	24.8 kg	24.8 kg
lbs	54 lbs. 11 oz.	54 lbs. 11 oz.	54 lbs. 11 oz.	54 lbs. 11 oz.

	KV-20FV300/ 21FV300 (N)	KV-21FV300 (S)	KV-24FV300/ 25FV300 (N)	KV-25FV300 (S)
Power requirements	120V, 60Hz	220V, 50/60Hz	120V, 60Hz	220V, 50/60Hz
Number of Inputs/Outputs				
Video ¹⁾	2	2	2	2
S Video ²⁾	1	1	1	1
Y, P _B , P _R ³⁾	1	1	1	1
Audio ⁴⁾	4	4	4	4
Audio Out ⁵⁾	1	1	1	1
Speaker output (W)	10W x 2	10W x 2	10W x 2	10W x 2
Headphones ⁵⁾	1	1	1	1
Power Consumption (W)				
In use (Max)	155W	155W	180W	180W
In Standby	1W	1W	1W	1W
Dimensions(W/H/D)				
mm	609 x 463 x 502 mm	609 x 463 x 502 mm	762 x 625 x 570 mm	762 x 625 x 570 mm
in	24 x 18 ^{1/4} x 19 ^{3/4}	24 x 18 ^{1/4} x 19 ^{3/4}	30 x 22 ^{7/16} x 24 ^{5/8}	30 x 24 ^{5/8} x 22 ^{7/16}
Mass				
kg	27 kg.	27 kg.	37 kg	37 kg
lbs	59 lbs. 8 oz.	59 lbs. 8 oz.	81 lbs. 9 oz.	81 lbs. 9 oz.

- 1) 1 Vp-p 75 ohms unbalanced, sync negative
- 2) Y: 1 Vp-p 75 ohms unbalanced, sync negative
C: 0.286 Vp-p (Burst signal), 75 ohms
- 3) Y: 1.0 Vp-p, 75 ohms, sync negative; PB: 0.7 Vp-p, 75 ohms;
PR Vp-p, 75 ohms.
- 4) 500 mVrms (100% modulation), Impedance: 47 kilohms
- 5) More than 408 mVrms at the maximum volume setting (variable)
More than 408 mVrms (fix); Impedance (output): 2 kilohms

Television system

American TV Standard, NTSC

Visible screen size

20/21-20 inch picture measured diagonally
24/25-24 inch picture measured diagonally

Antenna

75 ohm external terminal for VHF/UHF

Channel coverage

VHF: 2-13/ UHF: 14-69/ CATV: 1-125

Actual screen size

20/21-21 inch measured diagonally
24/25-25 inch measured diagonally

Picture tube

FD Trinitron[®] tube

Supplied Accessories

Remote Commander:

RM-Y172

(KV-21FM100 ONLY)

RM-Y173

(KV-20FS100/21FS100 ONLY)

RM-Y180

(KV-20FV300/21FV300/24FV300/25FV300 ONLY)

Size AA (R6) batteries (2)

Antenna, Telescopic

(KV-21FM100/21FS100/21FV300/25FV300 ONLY)

(●) SRS (SOUND RETRIEVAL SYSTEM)

The (●) SRS (SOUND RETRIEVAL SYSTEM) is manufactured by Sony Corporation under license from SRS Labs, Inc. It is covered by U.S. Patent No. 4,748,669. Other U.S. and foreign patents pending.

The word 'SRS' and the SRS symbol (●) are registered trademarks of SRS Labs, Inc.

BBE and BBE symbol are trademarks of BBE Sound, Inc. and are licensed by BBE Sound, Inc. under U.S. Patent No. 4,638,258 and 4,482,866.

Design and specifications are subject to change without notice.

WARNINGS AND CAUTIONS

CAUTION

Short circuit the anode of the picture tube and the anode cap to the metal chassis, CRT shield, or carbon painted on the CRT, after removing the anode.

WARNING!!

An isolation transformer should be used during any service to avoid possible shock hazard, because of live chassis. The chassis of this receiver is directly connected to the AC power line.

SAFETY-RELATED COMPONENT WARNING!!

Components identified by shading and  mark on the schematic diagrams, exploded views, and in the parts list are critical for safe operation. Replace these components with Sony parts whose part numbers appear as shown in this manual or in supplements published by Sony. Circuit adjustments that are critical for safe operation are identified in this manual. Follow these procedures whenever critical components are replaced or improper operation is suspected.

ATTENTION!!

Après avoir déconnecté le cap de l'anode, court-circuiter l'anode du tube cathodique et celui de l'anode du cap au châssis métallique de l'appareil, ou la couche de carbone peinte sur le tube cathodique ou au blindage du tube cathodique.

Afin d'éviter tout risque d'électrocution provenant d'un châssis sous tension, un transformateur d'isolement doit être utilisé lors de tout dépannage. Le châssis de ce récepteur est directement raccordé à l'alimentation du secteur.

ATTENTION AUX COMPOSANTS RELATIFS A LA SECURITE!!

Les composants identifiés par une trame et par une marque  sur les schémas de principe, les vues explosées et les listes de pièces sont d'une importance critique pour la sécurité du fonctionnement. Ne les remplacer que par des composants Sony dont le numéro de pièce est indiqué dans le présent manuel ou dans des suppléments publiés par Sony. Les réglages de circuit dont l'importance est critique pour la sécurité du fonctionnement sont identifiés dans le présent manuel. Suivre ces procédures lors de chaque remplacement de composants critiques, ou lorsqu'un mauvais fonctionnement suspecte.

SAFETY CHECK-OUT

After correcting the original service problem, perform the following safety checks before releasing the set to the customer:

1. Check the area of your repair for unsoldered or poorly soldered connections. Check the entire board surface for solder splashes and bridges.
2. Check the interboard wiring to ensure that no wires are "pinched" or touching high-wattage resistors.
3. Check that all control knobs, shields, covers, ground straps, and mounting hardware have been replaced. Be absolutely certain that you have replaced all the insulators.
4. Look for unauthorized replacement parts, particularly transistors, that were installed during a previous repair. Point them out to the customer and recommend their replacement.
5. Look for parts which, though functioning, show obvious signs of deterioration. Point them out to the customer and recommend their replacement.
6. Check the line cords for cracks and abrasion. Recommend the replacement of any such line cord to the customer.
7. Check the B+ and HV to see if they are specified values. Make sure your instruments are accurate; be suspicious of your HV meter if sets always have low HV.
8. Check the antenna terminals, metal trim, "metallized" knobs, screws, and all other exposed metal parts for AC leakage. Check leakage as described below.

Leakage Test

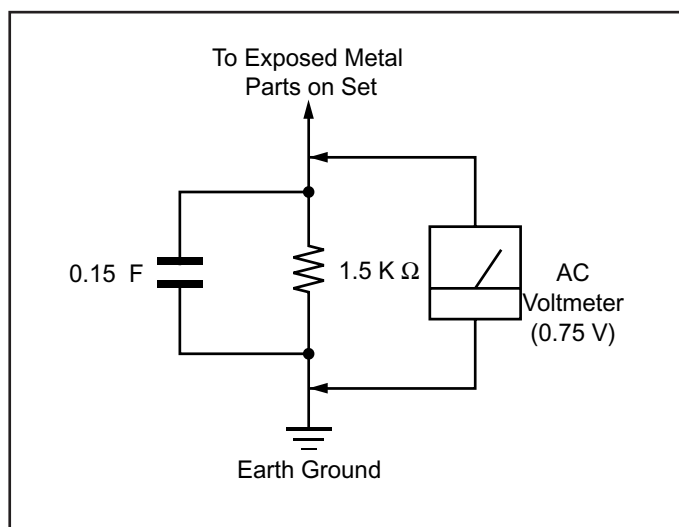

Figure A. Using an AC voltmeter to check AC leakage.

The AC leakage from any exposed metal part to earth ground and from all exposed metal parts to any exposed metal part having a return to chassis, must not exceed 0.5 mA (500 microamperes). Leakage current can be measured by any one of three methods.

1. A commercial leakage tester, such as the Simpson 229 or RCA WT-540A. Follow the manufacturers' instructions to use these instructions.
2. A battery-operated AC milliammeter. The Data Precision 245 digital multimeter is suitable for this job.
3. Measuring the voltage drop across a resistor by means of a VOM or battery-operated AC voltmeter. The "limit" indication is 0.75 V, so analog meters must have an accurate low voltage scale. The Simpson's 250 and Sanwa SH-63TRD are examples of passive VOMs that are suitable. Nearly all battery-operated digital multimeters that have a 2 VAC range are suitable (see Figure A).

How to Find a Good Earth Ground

A cold-water pipe is a guaranteed earth ground; the cover-plate retaining screw on most AC outlet boxes is also at earth ground. If the retaining screw is to be used as your earth ground, verify that it is at ground by measuring the resistance between it and a cold-water pipe with an ohmmeter. The reading should be zero ohms.

If a cold-water pipe is not accessible, connect a 60- to 100-watt trouble-light (not a neon lamp) between the hot side of the receptacle and the retaining screw. Try both slots, if necessary, to locate the hot side on the line; the lamp should light at normal brilliance if the screw is at ground potential (see Figure B).

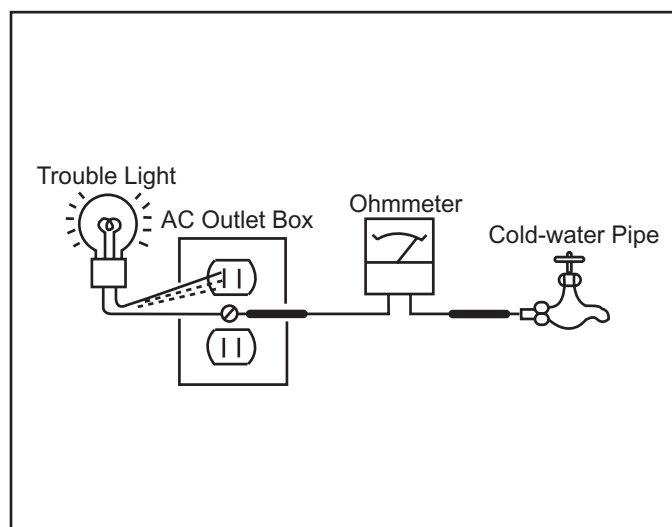

Figure B. Checking for earth ground.

SELF-DIAGNOSTIC FUNCTION



The units in this manual contain a self-diagnostic function. If an error occurs, the STANDBY/TIMER LED will automatically begin to flash. The number of times the LED flashes translates to a probable source of the problem. A definition of the STANDBY/TIMER LED flash indicators is listed in the instruction manual for the user's knowledge and reference. If an error symptom cannot be reproduced, the Remote Commander can be used to review the failure occurrence data stored in memory to reveal past problems and how often these problems occur.

Diagnostic Test Indicators

When an error occurs, the STANDBY/TIMER LED will flash a set number of times to indicate the possible cause of the problem. If there is more than one error, the LED will identify the first of the problem areas.

Results for all of the following diagnostic items are displayed on screen. No error has occurred if the screen displays a "0".

Diagnostic Item Description	No. of times STANDBY/ TIMER lamp flashes	Self-Diagnostic Display/ Diagnostic Result	Probable Cause Location	Detected Symptoms
Power does not turn on	Does not light	—————	<ul style="list-style-type: none"> Power cord is not plugged in. Fuse is burned out (F601). (A Board) 	<ul style="list-style-type: none"> Power does not come on. No power is supplied to the TV. AC Power supply is faulty.
+B overcurrent (OCP)*	2 times	2:0 or 2:1	<ul style="list-style-type: none"> H.OUT (Q505 OR Q506) is shorted. (A Board) IC1751 is shorted. (CV Board) 	<ul style="list-style-type: none"> Power does not come on. Load on power line is shorted.
I-Prot	4 times	4:0 or 4:1	<ul style="list-style-type: none"> +13V is not supplied. (A Board) IC1545 is faulty. (A Board) 	<ul style="list-style-type: none"> Has entered standby state after horizontal raster. Vertical deflection pulse is stopped. Power line is shorted or power supply is stopped.
IK (AKB)	5 times	5:0 or 5:1	<ul style="list-style-type: none"> Viedo OUT (IC1545) is faulty. (A Board) IC001 is faulty. (A Board) Screen (G2) is improperly adjusted.** 	<ul style="list-style-type: none"> No raster is generated. CRT Cathode current detection reference pulse output is small.

*If a +B overcurrent is detected, stoppage of the vertical deflection is detected simultaneously. The symptom that is diagnosed first by the microcontroller is displayed on the screen.

**Refer to Screen (G2) Adjustments in Section 2-4. of this manual.

Display of Standby/Timer LED Flash Count

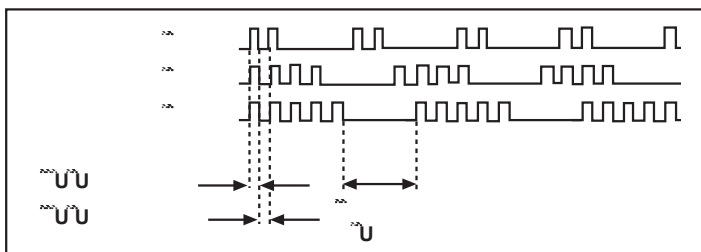

Diagnostic Item	Flash Count*
+B Overcurrent	2 times
I-Prot	4 times
IK (AKB)	5 times

*One flash count is not used for self-diagnostic.

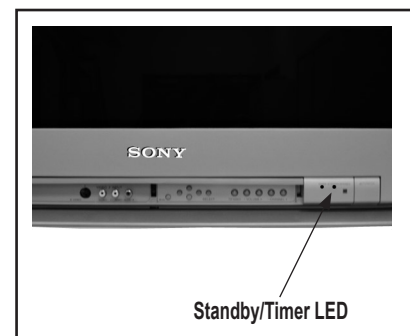

Stopping the Standby/Timer LED Flash

Turn off the power switch on the TV main unit or unplug the power cord from the outlet to stop the STANDBY/TIMER LAMP from flashing.

Self-Diagnostic Screen Display

For errors with symptoms such as “power sometimes shuts off” or “screen sometimes goes out” that cannot be confirmed, it is possible to bring up past occurrences of failure on the screen for confirmation.

To Bring Up Screen Test

In standby mode, press buttons on the Remote Commander sequentially, in rapid succession, as shown below:

Display → Channel 5 → Sound Volume → Power ON

↑ Note that this differs from entering the Service Mode (Sound Volume +).

Self-Diagnostic Screen Display

SELF DIAGNOSTIC
2: 000
3: N/A
4: 000
5: 001
101: N/A

Numeral “0” means that no fault was detected.
Numerical “1” means a fault was detected one time only.

Handling of Self-Diagnostic Screen Display

Since the diagnostic results displayed on the screen are not automatically cleared, always check the self-diagnostic screen during repairs. When you have completed the repairs, clear the result display to “0”.

Unless the result display is cleared to “0”, the self-diagnostic function will not be able to detect subsequent faults after completion of the repairs.

Clearing the Result Display

To clear the result display to “0”, press buttons on the Remote Commander sequentially when the diagnostic screen is displayed, as shown below:

Channel 8 → ENTER

Quitting the Self-Diagnostic Screen

To quit the entire self-diagnostic screen, turn off the power switch on the Remote Commander or the main unit.

Self-Diagnostic Circuit

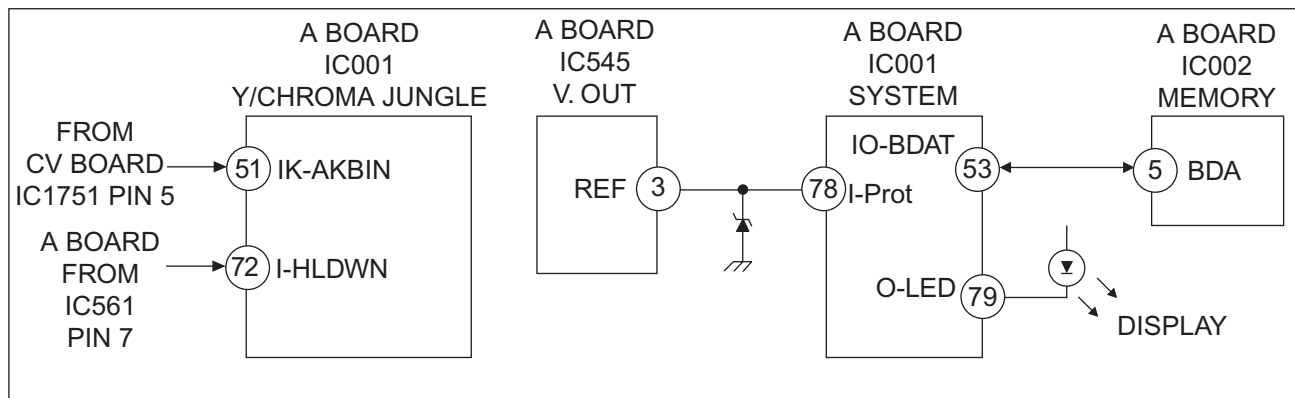

+B overcurrent (OCP)

Occurs when an overcurrent on the +B (135V) line is detected by pin 72 of IC001 (A Board). If the voltage of pin 72 of IC001 (A Board) is less than 1V when V.SYNC is more than seven verticals in a period, the unit will automatically turn off.

I-Prot

Occurs when an absence of the vertical deflection pulse is detected by pin 78 of IC001 (A Board). Power supply will shut down when waveform interval exceeds 2 seconds.

IK (AKB)

If the RGB levels* do not balance within 2 seconds after the power is turned on, this error will be detected by IC001 (A Board). TV will stay on, but there will be no picture.

*(Refers to the RGB levels of the AKB detection Ref pulse that detects 1K).

SECTION 1: DISASSEMBLY

1-1. REAR COVER REMOVAL

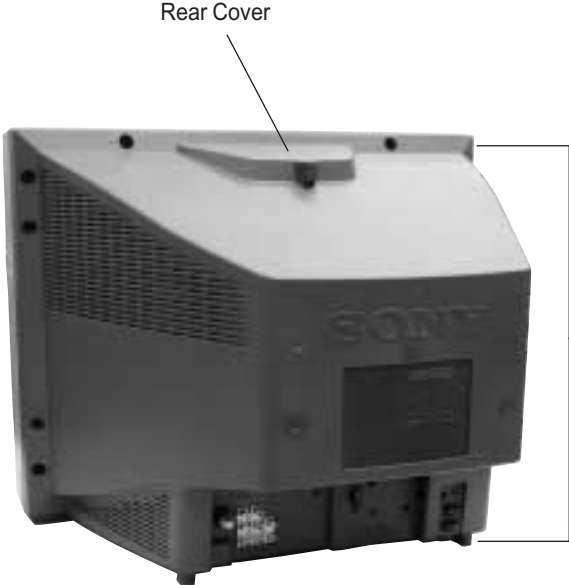

KV-20FS100/21FS100/21FM100 - 4 Screws +BVTP 4x16
KV-20FV300/21FV300 - 5 Screws +BVTP 4x16
KV-24FV300/25FV300 - 6 Screws +BVTP 4x16

1-2. CHASSIS ASSEMBLY REMOVAL

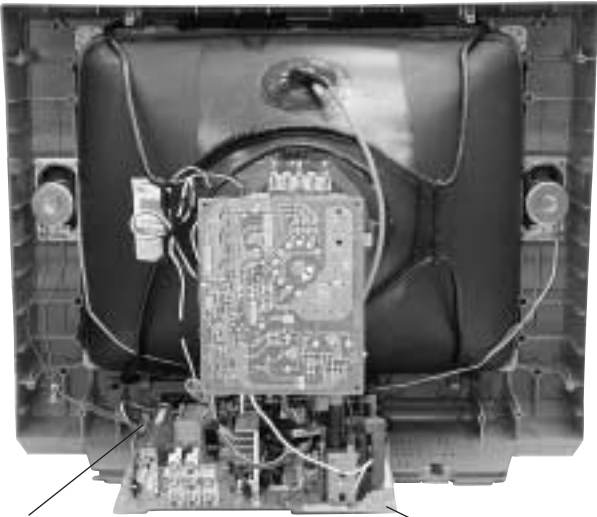

1-3. SERVICE POSITION

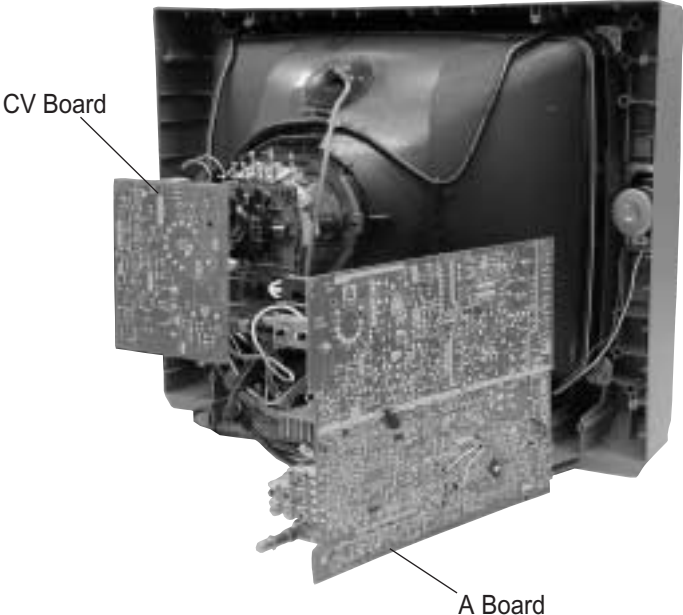

1-4. PICTURE TUBE REMOVAL

WARNING: BEFORE REMOVING THE ANODE CAP

High voltage remains in the CRT even after the power is disconnected. To avoid electric shock, discharge CRT before attempting to remove the anode cap. Short between anode and CRT coated earth ground strap.

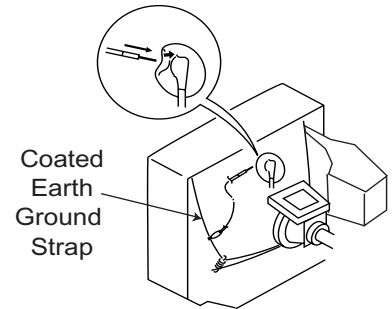
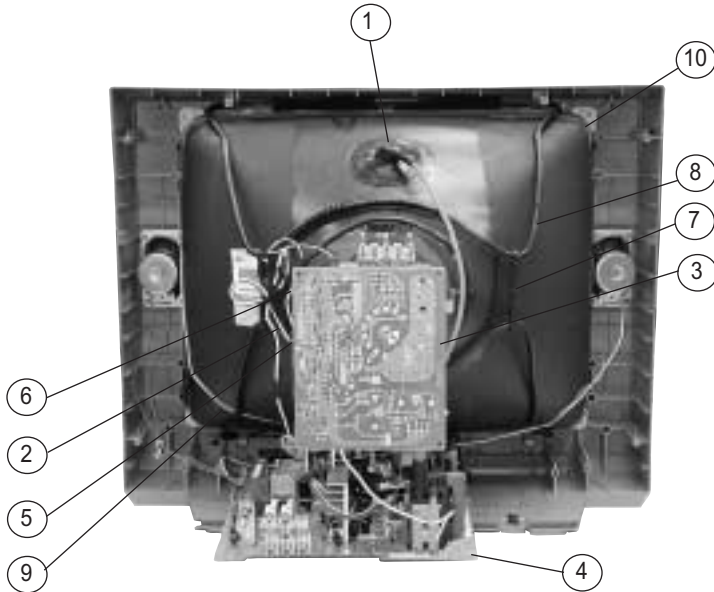

1. Discharge the anode of the CRT and remove the anode cap.
2. Unplug all interconnecting leads from the deflection yoke, neck assembly, degaussing coils and CRT grounding strap.
3. Remove the CV Board from the CRT.
4. Remove the chassis assembly.
5. Loosen the neck assembly fixing screw and remove.
6. Loosen the deflection yoke fixing screw and remove.
7. Place the set with the CRT face down on a cushion and remove the degaussing coil holders.
8. Remove the degaussing coils.
9. Remove the CRT grounding strap and spring tension devices.
10. Unscrew the four CRT fixing screws [located on each CRT corner] and remove the CRT [Take care not to handle the CRT by the neck].

ANODE CAP REMOVAL PROCEDURE

WARNING: High voltage remains in the CRT even after the power is disconnected. To avoid electric shock, discharge CRT **before** attempting to remove the anode cap. Short between anode and coated earth ground strap of CRT.

NOTE: After removing the anode cap, short circuit the anode of the picture tube and the anode cap to either the metal chassis, CRT shield, or carbon painted on the CRT.

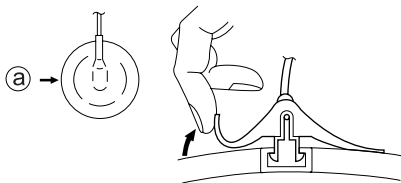

Turn up one side of the rubber cap in the direction indicated by arrow (a) .

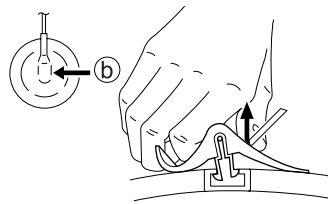

Use your thumb to pull the rubber cap firmly in the direction indicated by arrow (b) .

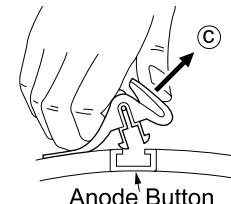

When one side of the rubber cap separates from the anode button, the anode cap can be removed by turning the rubber cap and pulling it in the direction of arrow (c) .

HOW TO HANDLE AN ANODE CAP

1. Do not use sharp objects which may cause damage to the surface of the anode cap.
2. To avoid damaging the anode cap, do not squeeze the rubber covering too hard. A material fitting called a shatter-hook terminal is built into the rubber.
3. Do not force turn the foot of the rubber cover. This may cause the shatter-hook terminal to protrude and damage the rubber.

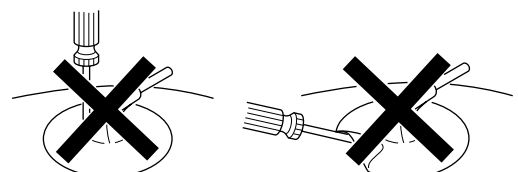

SECTION 2: SET-UP ADJUSTMENTS

The following adjustments should be made when a complete realignment is required or a new picture tube is installed.

These adjustments should be performed with rated power supply voltage unless otherwise noted.

Set the controls as follows unless otherwise noted:

VIDEO MODE: Standard

PICTURE CONTROL: Normal

BRIGHTNESS CONTROL: Normal

Perform the adjustments in order as follows:

1. Beam Landing
2. Convergence
3. Focus
4. Screen (G2)
5. White Balance

Note Test Equipment Required:

1. Color Bar Pattern Generator
2. Degausser
3. DC Power Supply
4. Digital Multimeter

2-1. BEAM LANDING

Before beginning adjustment procedure:

1. Degauss the entire screen.
2. Feed in the white pattern signal.

ADJUSTMENT PROCEDURE

1. Input a raster signal with the pattern generator.
2. Loosen the deflection yoke mounting screw, and set the purity control to the center as shown below:

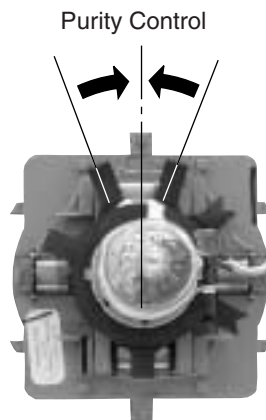

3. Turn the raster signal of the pattern generator to green.
4. Move the deflection yoke backward, and adjust with the purity control so that green is in the center and red and blue are even on both sides.

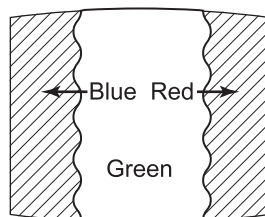

5. Move the deflection yoke forward, and adjust so that the entire screen becomes green.

6. Switch over the raster signal to red and blue and confirm the condition.
7. When the position of the deflection yoke is determined, tighten it with the deflection yoke mounting screw.
8. If landing at the corner is not right, adjust by using the disk magnets.

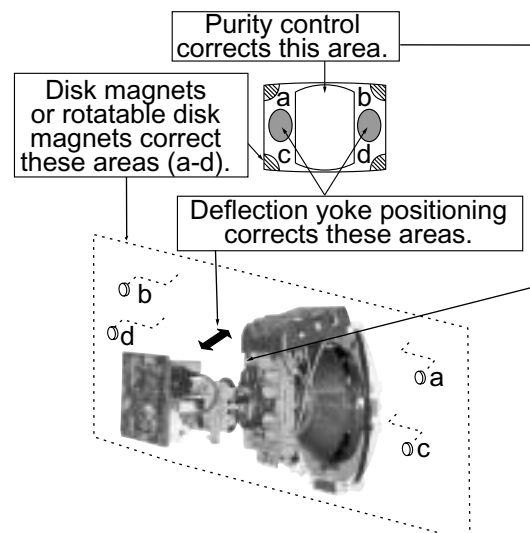
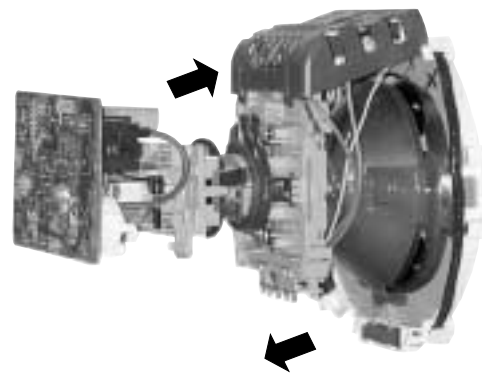

2-2. CONVERGENCE

Before starting convergence adjustments:

- 1 Perform FOCUS, VLIN and VSIZE adjustments.
2. Set BRIGHTNESS control to minimum.
3. Feed in dot pattern.

VERTICAL STATIC CONVERGENCE

1. Adjust V. STAT magnet to converge red, green and blue dots in the center of the screen (Vertical movement adjust S V. STAT RV1750 to converge).

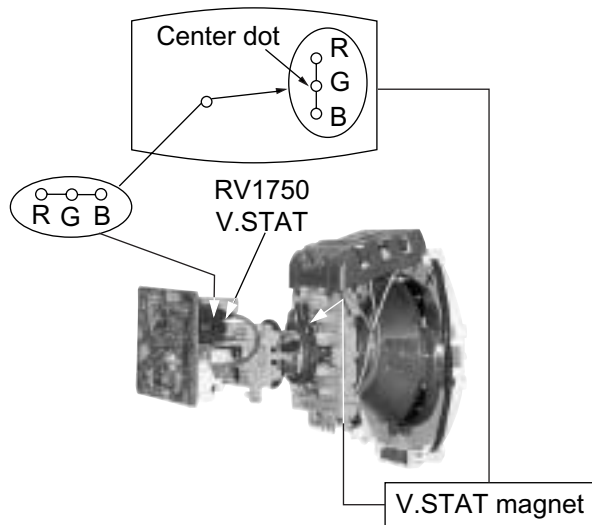

2. Tilt the V. STAT magnet and adjust static convergence to open or close the V. STAT magnet.

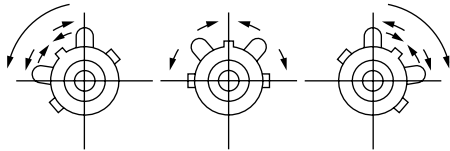

When the V. STAT magnet is moved in the direction of arrow a and b, red, green, and blue dots move as shown below:

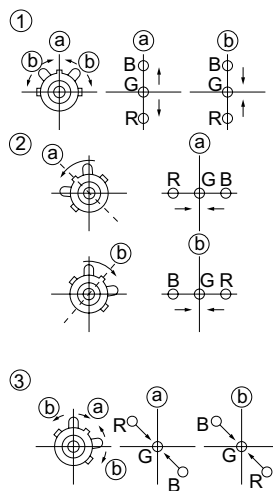

HORIZONTAL STATIC CONVERGENCE

If the blue dot does not converge with the red and green dots, perform the following:

1. Move BMC magnet (a) to correct insufficient H.Static convergence.
2. Rotate BMC magnet (b) to correct insufficient V.Static convergence.
3. After adjusting the BMC magnet, repeat Beam Landing Adjustment.

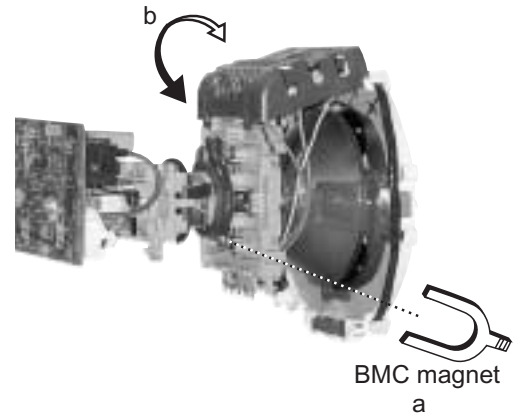
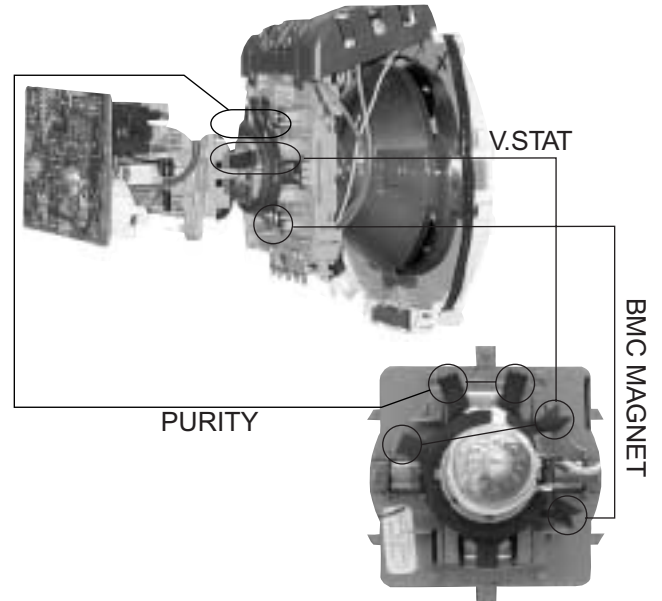

DYNAMIC CONVERGENCE ADJUSTMENT

Before performing this adjustment, perform Horizontal and Vertical Static Convergence Adjustment.

1. Slightly loosen deflection yoke screw.
2. Remove deflection yoke spacers.
3. Move the deflection yoke for best convergence as shown below:

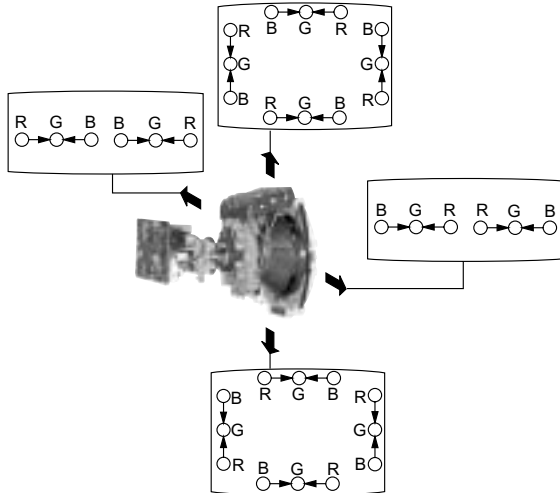

4. Tighten the deflection yoke screw.
5. Install the deflection yoke spacers.

TLH PLATE ADJUSTMENT

1. Input crosshatch pattern.
2. Adjust PICTURE QUALITY to standard, PICTURE and BRIGHTNESS to 50%, and OTHER to standard.
3. Adjust the Horizontal Convergence of red and blue dots by tilting the TLH plate on the deflection yoke.

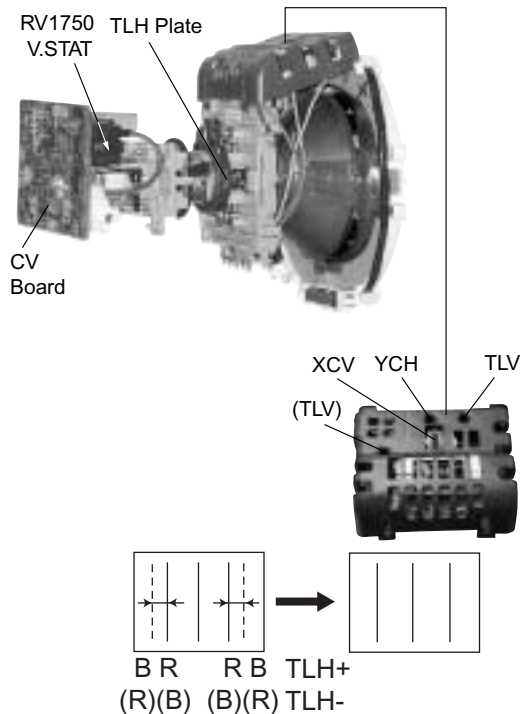

4. Adjust XCV core to balance X axis.
 5. Adjust YCH VR to balance Y axis.
 6. Adjust vertical red and blue convergence with V.TILT (TLV VR.)
- Note: Perform adjustment 3-6 while tracking items 1 and 2.

SCREEN-CORNER CONVERGENCE

1. Affix a permalloy assembly corresponding to the misconverged areas:

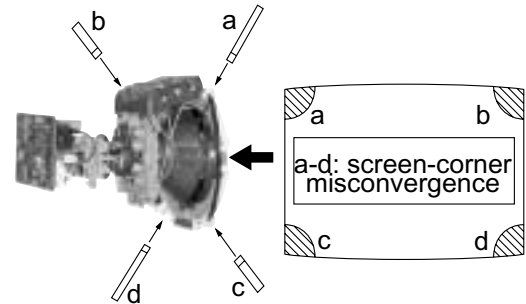

2-3. FOCUS

1. Adjust FOCUS control for best pictures.

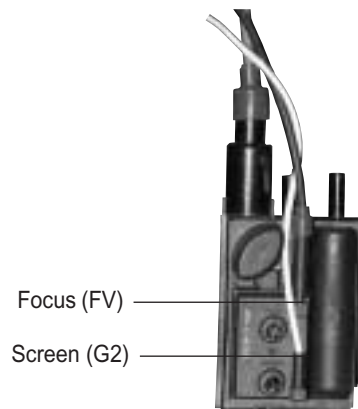

2-4. SCREEN (G2)

1. Input a dot pattern.
2. Set the PICTURE and BRIGHTNESS controls at minimum and COLOR control at normal.
3. Adjust SBRT, GCUT, BCUT in service mode with an oscilloscope as shown below so that voltages on the red, green, and blue cathodes are $170 \pm 2\text{VDC}$.

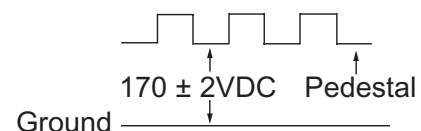

2-5. METHOD OF SETTING THE SERVICE ADJUSTMENT MODE

SERVICE MODE PROCEDURE

- Standby mode (power off).
- Press **[Display]** → Channel **[5]** → Sound Volume **[+]** → Power on the Remote Commander (press each button within a second).

SERVICE ADJUSTMENT MODE ON

- The CRT displays the time being adjusted.

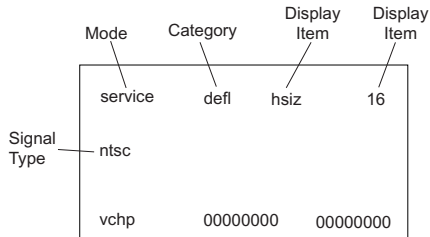

- Press **[1]** or **[4]** on the Remote Commander to select the time.
- Press **[3]** or **[6]** on the Remote Commander to change the data.
- Press **[MUTING]** then **[ENTER]** to save into the memory.

SERVICE ADJUSTMENT MODE MEMORY

Turn the set off then on to exit Service Adjustment Mode.

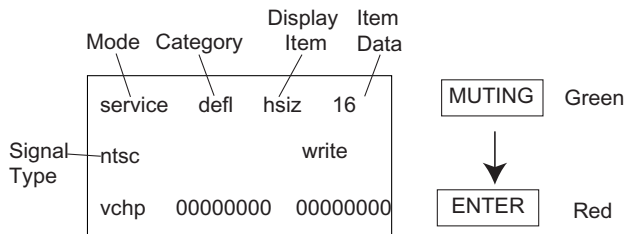

2-6. WHITE BALANCE ADJUSTMENTS

- Input an entire white signal with burst.
- Set to Service Adjustment Mode.
- Set the PICTURE and BRIGHTNESS to minimum.
- Adjust with SBRT if necessary.
- Select GCUT and BCUT with **[1]** and **[4]**.
- Adjust with **[3]** and **[6]** for the best white balance.
- Set the PICTURE and BRIGHTNESS to maximum.
- Select GDRV and BDRV with **[1]** and **[4]**.
- Adjust with **[3]** and **[6]** for the best white balance.
- To write into memory, press **[MUTING]** then **[ENTER]**.

SECTION 3: SAFETY RELATED ADJUSTMENTS

3-1. R565 CONFIRMATION METHOD (HV HOLD-DOWN CONFIRMATION) AND READJUSTMENTS

The following adjustments should always be performed when replacing the following components which are marked with on the schematic diagram:

Part Replaced ()	Adjustment ()
DY, T585, CRT, IC001, IC561, C507, C508, C506, T511, L510, C588, L588, C566, C561, C563, D567, D568, D566, R567, R568, R565, R566, R562, R563, R561, R528.....A Board	HV HOLD-DOWN R565

PREPARATION BEFORE CONFIRMATION

1. Using a Variac, apply AC input voltage: 120 ±2 VAC.
2. Turn the POWER switch ON.
3. Input a white signal and set the PICTURE and BRIGHTNESS controls to maximum.
4. Confirm that the voltage between C566 (+) or TP30 and ground is more than 97.0 VDC.

HOLD-DOWN OPERATION CONFIRMATION

1. Connect the current meter between Pin 11 of the FBT (T585) and the PWB land where Pin 11 would normally attach (See Figure 1 on the next page).
2. Input a dot signal and set PICTURE and BRIGHTNESS to minimum: IABL = 100 ± 100µA.
3. Confirm the voltage of A Board TP-23 is 135.6 ± 1V.
4. Connect the digital voltmeter and the DC power supply via Diode 1SS119 to C566 (+) and ground (See Figure 1 on next page).
5. Increase the DC power voltage gradually until the picture blanks out.
6. Turn DC power source off immediately.
7. Read the digital voltmeter indication (standard < 117VDC).
8. Input a white signal and set PICTURE and BRIGHTNESS to maximum: IABL = 1350 ± 100µA.
9. Repeat steps 4 to 7.

HOLD-DOWN READJUSTMENT

If the setting indicated in Step 2 of Hold-Down Operation Confirmation cannot be met, readjustment should be performed by altering the resistance value of R565 component marked with .

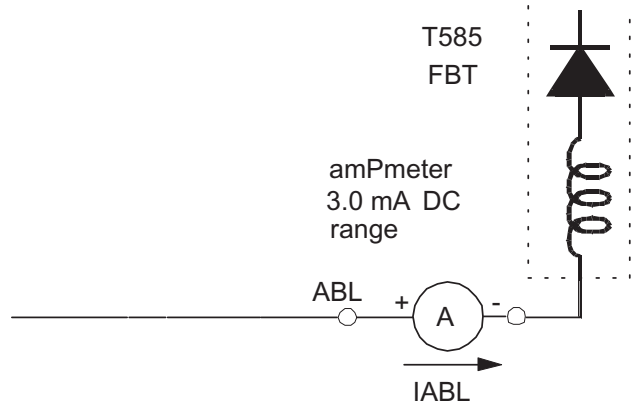

3-2. B+ VOLTAGE CONFIRMATION AND ADJUSTMENT

Note: The following adjustments should always be performed when replacing the following components, which are marked with on the schematic diagram on the A Board:

A BOARD: IC600, PH602

1. Using a Variac, apply AC input voltage: 130 + 2.0 / - 0.0 VAC.
2. Input a DOT pattern at Q.C.
3. Set the PICTURE and the BRIGHTNESS controls to minimum.
4. Confirm the voltage of A Board between TP-23 & Ground is <136.6 VDC.
5. If step 4 is not satisfied, replace the components listed above, then repeat Steps 1 – 3.

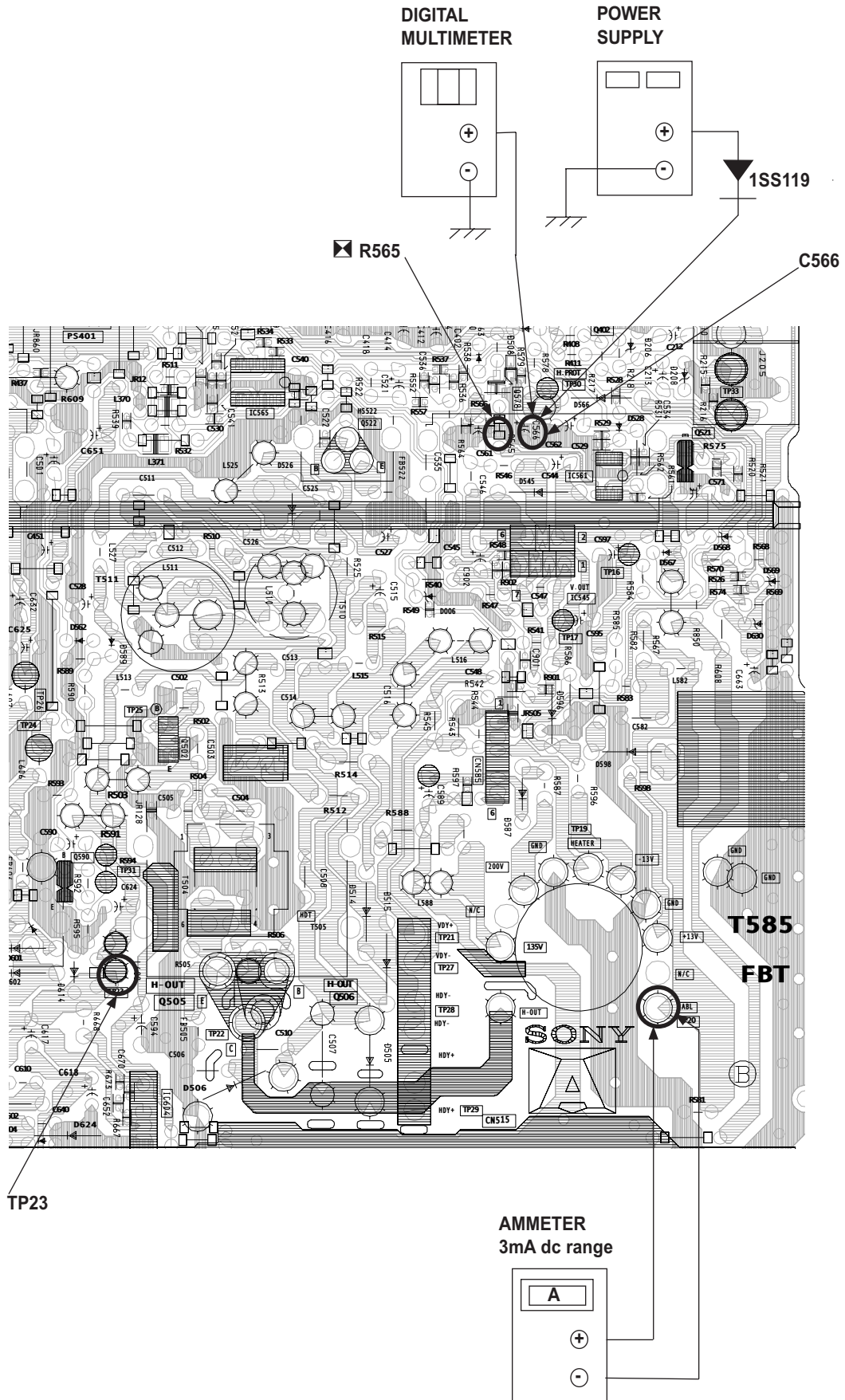

Figure 1

SECTION 4: CIRCUIT ADJUSTMENTS

ELECTRICAL ADJUSTMENTS BY REMOTE COMMANDER

Use the Remote Commander (RM-Y172, RM-Y173, RM-Y180) to perform the circuit adjustments in this section.

Test Equipment Required: 1. Pattern generator 2. Frequency counter 3. Digital multimeter 4. Audio oscillator

4-1. SETTING THE SERVICE ADJUSTMENT MODE

- Standby mode (Power off).
- Press the following buttons on the remote commander within a second of each other:

Display → Channel 5 → Sound Volume + → Power

SERVICE ADJUSTMENT MODE ON

- The CRT displays the item being adjusted.

Mode	Category	Display Item	Item Data
service	defl	hsiz	16
Signal Type	ntsc		
vchp	00000000	00000000	

- Press **1** or **4** on the Remote Commander to select the item.
- Press **3** or **6** on the Remote Commander to change the data.
- Press **MUTING** then **ENTER** to write into memory.

SERVICE ADJUSTMENT MODE MEMORY

Mode	Category	Display Item	Item Data
service	defl	hsiz	16
Signal Type	ntsc		write
vchp	00000000	00000000	

MUTING Green
 ↓
ENTER Red

- Press **8** then **ENTER** on the Remote Commander to initialize.

Mode	Category	Display Item	Item Data
service	defl	hsiz	16
Signal Type	ntsc		write
vchp	00000000	00000000	

MUTING Green
 ↓
ENTER Red

Carry out Step 1 when adjusting IDs 0-6 and when replacing and adjusting IC002

- Turn set off then on to exit Service Adjustment Mode.

4-2. MEMORY WRITE CONFIRMATION METHOD

- After adjustment, pull out the plug from the AC outlet, then replace the plug in the AC outlet again.
- Turn the power switch ON and set to Service Mode.
- Call the adjusted items again to confirm they were adjusted.

4-3. REMOTE ADJUSTMENT BUTTONS AND INDICATORS

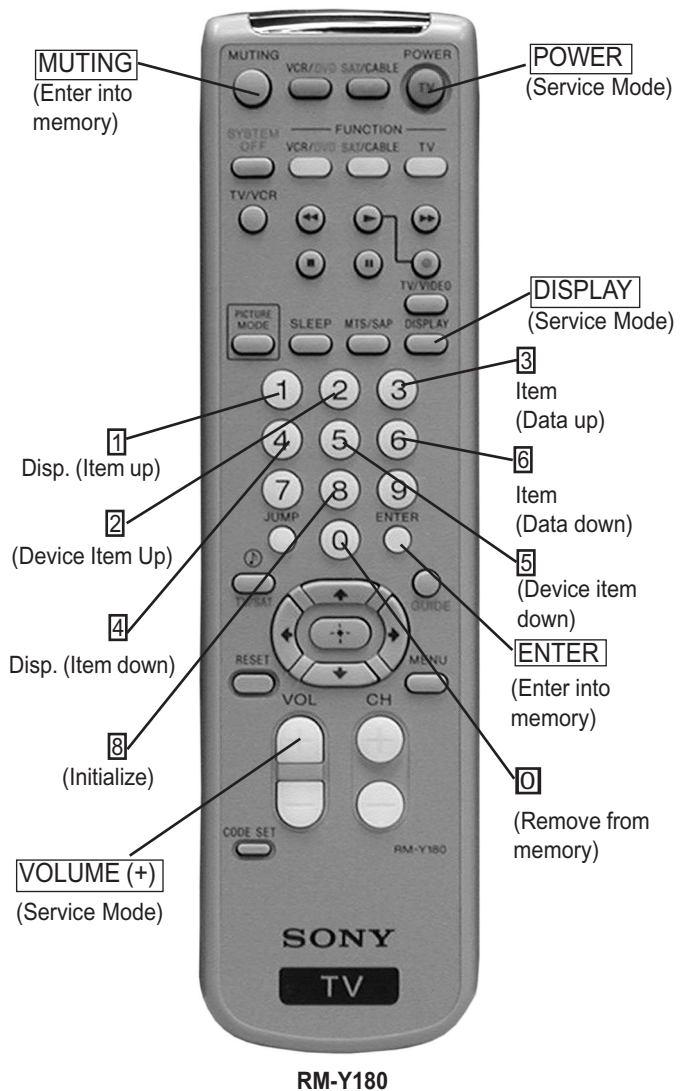

ADJUSTMENT ITEMS (1 OF 8)

DEVICE "DEF"

Item#	OSD	DETAIL	Range (DEC)	Initial Data
1	HSIZ	H SIZE(EW DC)	00-63	25
2	HPOS	H POSITION	00-63	41
3	VSIZ	V RAMP SIZE	00-63	25
4	VPOS	V POSITION(RAMP DC)not useful	00-63	34
5	VLIN	V LINEARITY	00-63	36
6	SCOR	S CORRECTION	00-63	39
7	VBOW	BOW	00-63	36
8	VANG	ANGLE	00-63	35
9	TRAP	EW TRAPESIUM	00-63	29
10	PAMP	EW PIN	00-63	39
11	UPIN	UPPER PIN	00-63	28
12	LPIN	LOWER PIN	00-63	29
13	TROT	TROT	00-255	128
14	HBLK	H BLK mode select	00-01	0
15	LBLK	HBLK front timing	00-63	5
16	RBLK	HBLK rear timing	00-15	31
17	VBLK	V BLK width	00-03	0
18	HMSK	TOP VEND(when MACROVISION)prevent OFF	00-01	0
19	HDW	H PULSE WIDTH(25u/19u)	00-01	1
20	AFC	AFC GAIN	00-01	0
21	AFC1	AFC1 TIME CONSTANT	00-07	3
22	AFCW	AFC1 PULL IN WIDE	00-01	1
23	CDMD	V DET WINDOW SW TIMING	00-03	1
24	HSS	SYNC SLICE LEVEL(H sepa)	00-03	0
25	VSS	SYNC SLICE LEVEL(V sepa)	00-03	3
26	SLDN	Auto Slice level DOWN	00-03	0
27	SLUP	Auto Slicelevel UP	00-01	0
28	JPSW	Jump SW	00-01	0
29	HOSC	H VCO fo ADJUST	00-255	5
30	EHT	EHT	00-15	6
31	EHTG	EHT MODE	00-01	0

DEVICE "16:9"

Item#	OSD	DETAIL	Range (DEC)	Initial Data
1	PAMP	EW PIN	00-63	59
2	UPIN	UPPER PIN	00-63	15
3	LPIN	LOWER PIN	00-63	21
4	ACLV	ACL VTH	00-03	0
5	ABLV	ABL VTH	63-00	58

DEVICE "VP1"

Item#	OSD	DETAIL	Range (DEC)	Initial Data
1	RDRV	R DRIVE	00-127	55
2	GDRV	G DRIVE when Color Temp. is "Cool" and "Neutral"	00-127	38
3	BDRV	B DRIVE when Color Temp. is "Cool" and "Neutral"	00-127	47
4	RCUT		00-1023	130
5	GCUT		00-1023	90
6	BCUT		00-1023	72
7	SCON	CONTRAST LEVEL	00-127	20
8	SHUE	TINT	00-127	8
9	SCOL	COLOR LEVEL	00-127	17
10	SBRT	BRIGHT	00-255	35
11	RON	R OUTPUT MUTE	00-01	1
12	GON	G OUTPUT MUTE	00-01	1
13	BON	B OUTPUT MUTE	00-01	1
14	BLLV	BLUE STRETCH(00:no <-> 11:deep)	00-03	1
15	MTRX	MATRIX RATIO SELECT	00-03	2
16	AXIS	R-Y PHASE OFFSET	00-63	48
17	SSHO	SHARPNESS GAIN(OVER)	00-63	17
18	SSHP	SHARPNESS GAIN(PRE)	00-63	26
19	SHPF	SHRPNESS fo(00:2 CLK <-> 11:5 CLK)	00-03	1

ADJUSTMENT ITEMS (2 OF 8)

DEVICE "VP1"

Item#	OSD	DETAIL	Range (DEC)	Initial Data
20	SHCL	SHARPNESS CPRING LEVEL	00-15	0
21	SHMX	SHARPNESS LIMITER LEVEL	00-15	15
22	ACLV	ACL VTH	00-03	0
23	ABLV	ABL VTH	00-63	0
24	AKBD	AKB Self Diagnostic Counter(@1sec)	00-07	7
25	AKBS	AKB H/W S/W Switch	00-02	1
26	REFP	AKB REFPLS timing	00-01	1
27	YNRC	YNR LIMITER LEVEL	00-15	15
28	BKON	BLACK STRETCH ON	00-01	1
29	BKTH	BLACK STRETCH DETECTOR TRESH LEVEL	00-255	22
30	BKAR	BLACK STRETCH DETECTOR TRESH AREA	00-03	1
31	BKSP	BLACK STRETCH START POINT	00-03	1

DEVICE "VP2"

Item#	OSD	DETAIL	Range (DEC)	Initial Data
1	VMLO	VM LEVEL at "Low" Setting	00-15	10
2	VMHI	VM LEVEL at "High" Setting	00-15	15
3	VMDL	VM DELAY	00-15	6
4	VMPL	VM PORALITY	00-01	0
5	VMWD	VM WIDTH	00-03	0
6	VMCL	VM CORING LEVEL	00-15	0
7	VMMX	VM LIMITER LEVEL	00-15	15
8	CKLV	COLOR KILLER VTH	00-127	1/YUV:0
9	CKON	FORCE KILLER	00-01	0
10	ALFA	ADAPTIVE DET SENSITIVITY	00-03	2
11	YCMD	YC SEPA FORCE SELECT(00:ADAPTIVE 01:H 10:V 11:HV)	00-03	0
12	VACL	V APERTURE CORING LEVEL	00-15	0
13	VAGA	V APERTURE GAIN LEVEL	00-15	Soft Cont'l
14	VAMX	V APERTURE LIMITER LEVEL	00-15	3
15	GAMM	GANMA(00:no <-->11:deep)	00-03	Soft Cont'l
16	YDLY	Y DELAY TIME	00-03	3/YUV:3
17	CDLY	C DELAY	00-03	2/YUV:2
18	YOFF	Y OUTPUT MUTE	00-01	0
19	CBPF	C BPF fo HI	00-01	0/YUV:0
20	CLIM	C OUTPUT LIMITTER	00-15	15
21	YFSL	Y BAND WIDTH	00-03	0
22	CFSL	C BAND WIDTH	00-03	0
23	BGPP	BGP(for C DECODER)TIMING	00-31	8
24	NRCH	NOISE DET TIME CONSTANT	00-03	0
25	NRCL	NOISE DET TIME CONSTANT	00-255	8
26	NRVL	NOISE DET VTH	00-255	16
27	NRVH	NOISE DET VTH	00-255	0
28	GDOF	G DRIVE	00-31	18
29	BDOF	B DRIVE	00-31	31
30	GCOF	G CUTOFF	00-31	02
31	BCOF	B CUTOFF	00-31	00
32	DCTV	DCTTRANSFER VTH	00-127	5
33	DCTG	DCTTRANSFER GAIN	00-31	Soft Cont'l

ADJUSTMENT ITEMS (3 OF 8)**DEVICE "VIVID"**

Item#	OSD	DETAIL	Range (DEC)	Initial Data
1	VPIC	Picture(VIVID)	00-63	63
2	VBRI	Brightness(VIVID)	00-63	31
3	VCOL	Color(VIVID)	00-63	37
4	VHUE	Hue(VIVID)	00-63	31
5	VSHA	Sharpness(VIVID)	00-63	31
6	VVM	VM(VIVID)	00-02	2
7	VTRI	Color Temp(VIVID)	00-02	0
8	VAPA	Aperture G(VIVID)	00-15	7
9	VGMA	Gamma(VIVID)	00-03	3
10	DCTG	DCT LV(VIVID)	00-03	16

DEVICE "STD"

Item#	OSD	DETAIL	Range (DEC)	Initial Data
1	VPIC	Picture(STANDARD)	00-63	50/FEFS:63
2	VBRI	Brightness(STANDARD)	00-63	37/FEFS:31
3	VCOL	Color(STANDARD)	00-63	31/FEFS:37
4	VHUE	Hue(STANDARD)	00-63	31/FEFS:31
5	VSHA	Sharpness(STANDARD)	00-63	31/FEFS:31
6	VVM	VM(STANDARD)	00-02	1/FEFS:2
7	VTRI	Color Temp(STANDARD)	00-02	1/FEFS:0
8	VAPA	Aperture G(STANDARD)	00-15	7/FEFS:7
9	VGMA	Gamma(STANDARD)	00-03	3/FEFS:3
10	DCTG	DCT LV(STANDARD)	00-03	16/FEFS:16

DEVICE "MOVIE"

Item#	OSD	DETAIL	Range (DEC)	Initial Data
1	VPIC	Picture(MOVIE)	00-63	31
2	VBRI	Brightness(MOVIE)	00-63	51
3	VCOL	Color(MOVIE)	00-63	25
4	VHUE	Hue(MOVIE)	00-63	31
5	VSHA	Sharpness(MOVIE)	00-63	31
6	VVM	VM(MOVIE)	00-02	0
7	VTRI	Color Temp(MOVIE)	00-02	2
8	VAPA	Aperture G(MOVIE)	00-15	7
9	VGMA	Gamma(MOVIE)	00-03	3
10	DCTG	DCT LV(MOVIE)	00-03	16

DEVICE "SPORTS"

Item#	OSD	DETAIL	Range (DEC)	Initial Data
1	VPIC	Picture(SPORTS)	00-63	63
2	VBRI	Brightness(SPORTS)	00-63	31
3	VCOL	Color(SPORTS)	00-63	40
4	VHUE	Hue(SPORTS)	00-63	31
5	VSHA	Sharpness(SPORTS)	00-63	31
6	VVM	VM(SPORTS)	00-02	2
7	VTRI	Color Temp(SPORTS)	00-02	0
8	VAPA	Aperture G(SPORTS)	00-15	7
9	VGMA	Gamma(SPORTS)	00-03	3
10	DCTG	DCT LV(SPORTS)	00-03	16

ADJUSTMENT ITEMS (4 OF 8)

DEVICE "Y"

Item#	OSD	DETAIL	Range (DEC)	Initial Data
1	COFI	0:4 Linedelaies 1:2 Linedelaies	00-01	0
2	YNRS	YNR ON	00-01	0
3	YTHR	Y SIGNAL GENERATE from 2DYCS	00-01	0
4	Y2D	Y SIGNAL GENERATE from 2DYCS	00-01	0
5	2DFX	C SIGNAL GENELATE from H/V BPF only	00-01	1
6	CLPS	Y CLAMP TIME CONSTANT	00-01	1
7	VLPF	Y_LPF(ANALOG) fo Ajust	00-03	3
8	CLPF	C_LPF(ANALOG) fo Ajust	00-03	3
9	BKHS	BLACK STRETCH HYSTERISYS	00-31	1
10	BPFB	YCS HBPf SELECT(BACK)	00-03	1
11	BPFF	YCS HBPf SELECT(FRONT)	00-01	1

DEVICE "C"

Item#	OSD	DETAIL	Range (DEC)	Initial Data
1	FORG	CHROMA DECODER PHASE SELECT	00-03	0
2	FSEL	CHROMA DECODER CLK SELECT	00-01	0/YUV:0
3	ACTL	ANALOG ACC AMP MAX GAIN	00-03	3
4	A1FL	ANALOG ACC hysteresis	00-255	34
5	A1FH		00-01	0
6	A1ON	ANALOG ACC AMP ON LEVEL	00-127	12
7	MV	MACROVISION(BURST) DET TRESH	00-15	0
8	MV1S	MACROVISION(BURST) DET ON	00-01	1
9	MV2S	MACROVISION(BURST) DET POSITION	00-01	1
10	ACCS	ACC ON/OFF	00-01	0/YUV:1
11	KILS	KILLER DET SELECT	00-01	0/YUV:1
12	AASL	C DECODER TIME CONSTANT(32,16,8,1H)	00-03	3
13	BASL	ACC TIME CONSTANT	00-03	0
14	ATIM	ANALOG ACC HISTERISYS SELECT	00-03	0
15	VMSK	ACC V BLK OFF WIDTH	00-07	0
16	A3ON	ACC MAX GAIN	00-01	0
17	INTE	C DECODER INTRGRATOR ENABLE	00-01	0
18	SIN	C DECODER PHASE V ENABLE	00-01	0
19	CKVT	PLL STOP BURST LEVEL	00-03	1
20	XFFR	VCXO FORCE FREERUN	00-01	0/YUV:1
21	ACCV	C DECODER PHASE V ENABLE	00-01	1
22	BWSL	KILLER DET SELECT	00-01	1/YUV:1
23	BWDT	PLL KILLER VTH	00-03	0/YUV:3
24	A23E	AMP2,3 ON/OFF ENABLE(0 FIX)	00-01	1
25	A2ON	ABL VTH	00-127	12
26	A3ON	ACL VTH	00-127	12
27	A2FL	AMP2 OFF LEVEL lower	00-255	34
28	A2FH	AMP2 OFF LEVEL upper	00-01	0
29	A3FL	AMP3 OFF LEVEL lower	00-255	34
30	A3FH	AMP3 OFF LEVEL upper	00-01	0
31	AXTH	AXS HYS	00-63	30
32	ACTH	ROM HYS	00-63	10
33	AVAV	AVE SEL AV	00-03	3
34	B2TH	B2COMP	00-127	0

ADJUSTMENT ITEMS (5 OF 8)

DEVICE "RGB"

Item#	OSD	DETAIL	Range (DEC)	Initial Data
1	AMUT	RGB POWER ON MUTE	00-01	0
2	PMUT	RGB MUTE(EXCEPT OSD)	00-01	1
3	VBLK		00-01	0
4	CORL	R CUTOFF lower	00-255	100
5	CORH	R CUTOFF upper	00-01	1
6	COGL	G CUTOFF lower when Color Temp. is "Cool" and "Neutral"	00-255	125
7	COGH	G CUTOFF upper when Color Temp. is "Cool" and "Neutral"	00-01	1
8	COBL	B CUTOFF lower when Color Temp. is "Cool" and "Neutral"	00-255	125
9	COBH	B CUTOFF upper when Color Temp. is "Cool" and "Neutral"	00-01	1
10	ABLS	ABL SELECT (ON:00, OFF:01)	00-01	0
11	ACLS	ACL ON (ON:00, OFF:01)	00-01	1
12	ALSP	ACL SPEED	00-03	1
13	ALRS	ACL RECOVER SPEED	00-15	2
14	ALAS	ACL ATTACK SPEED	00-15	9
15	ABLG	ABL GAIN	00-15	15
16	ALS2	ACL ATTACK SPEED(2)	00-03	2
17	AKBS	AKB MODE	00-01	1
18	AKBP	AKB PULSE HEIGHT	00-63	40
19	OSDL	OSD LIMMIT SELECT	00-01	0
20	MPXS	UV MULTIPLEX ON	00-01	0/YUV:0
21	CXUV	YC/YUV SELECT	00-01	0/YUV:1
22	UVIN	U/V INVERT	00-01	0/YUV:0
23	UVOS	UV OFFSET CANCELER ON	00-01	0/YUV:0
24	ACL	SOFT ACL CONTROLE	00-63	63
25	HBLK	H BLK OFF	00-01	0
26	VENS	V-latch OFF	00-01	0
27	UOFS	U IN OFFSET	00-15	4
28	VOFS	V IN OFFSET	00-15	9
29	AABL	ANALOG ABL THRESHOLD LEVEL CONTROL	00-15	0
30	AABG	ANALOG ABL GAIN CONTROL	00-01	0
31	AALG	ANALOG ACL GAIN CONTROL	00-01	0
32	AABS	ANALOG ABL ON/OFF CONTROL (ON:01, OFF:00)	00-01	0
33	AALS	ANALOG ACL ON/OFF CONTROL (ON:01, OFF:00)	00-01	1

ADJUSTMENT ITEMS (6 OF 8)

DEVICE "DEFD"

Item#	OSD	DETAIL	Range (DEC)	Initial Data
1	VSTP	V OUTPUT STOP	00-01	0
2	HFFR	AFC1 FORCE FREERUN	00-01	0
3	HFUP	H FREERUN FREQUENCY UP(700Hz)	00-01	0
4	VPHA	V PHASE(V POSITION ADJUST)	00-15	0
5	JSWW	Jump Pulse Width	00-01	0
6	EWG	EWV AD OUTPUT LEVEL(6db)	00-01	0
7	EWCL	EW/VRAMP DA CLOCK SELECT	00-03	2/YUV:2
8	EWDI	EW/VRAMP DA DITHER	00-01	0
9	XF0A	VCXO FREERUN ADJUST	00-15	0
10	BGST	BGP(for PLL) TIMING	00-63	17
11	SKWI	Skew correcter refernce phase	00-01	0/YUV:0
12	XPHA	VCXO PHASE ADJUST	00-15	10
13	SKEW	Skew correcterphase controle	00-07	0/YUV:3
14	HRMP	AFC2 TIME CONSTANT	00-03	0
15	RPLU	REF PLL TIME CONSTANT	00-07	3
16	RPLB	REF PLL TIME CONSTANT	00-01	1
17	XF0B	VCXO Fo ADJUST	00-03	0
18	RPLS	REF VCO FB LOOP SELECT	00-01	0
19	SSM	SyncSepaMasking CONTROL	00-01	0
20	VSAG	V-SAG prevent ON	00-01	0
21	AFC2	AFC2 GAIN CONTROL	00-03	0
22	VRFL	V RAMP FILTER SWITCHING OFF	00-01	0
23	SSLP	LPF pre SYNC SEPA ON/OFF	00-01	0
24	IMTS	I.M. TEST	00-01	0
25	XPLU	ACP TIME CONSTANT	00-01	0
26	8FSC	8fscCLK Skew OFF	00-01	1/YUV:1
27	4FS2	4fscCLK Skew OFF	00-01	1/YUV:1
28	EWVR	DSDAC V RESET Enable	00-01	0
29	VLOF	IIC V Latch OFF(for TEST)	00-01	0
30	1WIN	FORCE 1Window	00-01	1
31	BGPC	ANGLE Return current up	00-01	0
32	MHDL	ANGLE Return current up timing	00-01	1
33	BFRE	force V FREERUN	00-01	0
34	ANGG	ANGLE Retun current up	00-01	1
35	ANGT	ANGLE Retun current up timing	00-01	0
36	DOSD	Digital OSD ON	00-01	0
37	ANGS	AFC2 ANGLE/BOW INHIBIT	00-01	0
38	HRPP	FRAMP RRAMP H OUT CONTROL RANGE	00-15	8
39	VF50	FORCE V FREERUN 50Hz	00-01	0
40	CLKS	TBC clock system select	00-03	0
41	VBHK	V BLK HALF KILL	00-01	0
42	DSYC	CVBS INPUT CONTROL	00-01	0
43	VPW	V Pulse Wide	00-01	1
44	QSW	MODULATOR FEEDBACK GAIN CONTROL	00-01	0
45	ADTY	CLOCK DUTY CONTROL at IIC QSWITCH=ON	00-01	0
46	DTH	DITHER THRESHOLD LEVEL CONTROL at IIC AUTOD=ON	00-03	1
47	HBSW	HBLK REFERENCE AFC1/AFC2	00-01	0
48	DSCS	•DAC CLOCK ON/OFF CONTROL	00-01	0

ADJUSTMENT ITEMS (7 OF 8)

DEVICE "OTHER"

Item#	OSD	DETAIL	Range (DEC)	Initial Data
1	PCLP	SYNC TIP/PEDESTAL CLAMP SELECT	00-01	0
2	VRT	ADC REFERENCE (00:1.15Vpp 01:1.25Vpp 10:1.35Vpp 11:1.45Vpp)	00-03	1/YUV:1
3	AM	INTERIGENT MONITOR OUTPUT SELECT(analog)	00-15	0
4	DME	INTERIGENT MONITOR OUTPUT SELECT(degital)	00-01	0
5	DM	INTERIGENT MONITOR OUTPUT SELECT(degital)	00-31	0
6	14HI	4fsc(Skew)CLK POLARITY	00-01	0
7	14HD	4fscCLK(Skew)CLK DELAY ADJUST	00-03	1
8	28I	8fscCLK POLARITY	00-01	1
9	28D	8fscCLK DELAY ADJUST	00-03	1
10	ADCD	ADC CLK DELAY ADJUST	00-03	1/YUV:0
11	CLKS	AD/LOGIC CLK SWAP	00-01	0/YUV:0
12	HDSL	HD OUT(for MCU)SELECT	00-01	1
13	CPSL	PLL CP LATCH ON	00-01	0
14	CPCL	PLL CP LATCH CLOCK	00-01	0
15	CPCP	PLL CP LATCH POLARTY	00-01	0
16	DUMY	DUMMY	00-0F	1

DEVICE "OSD"

Item#	OSD	DETAIL	Range (DEC)	Initial Data
1	HT	HALF TONE LEVEL	00-03	0
2	OSLR	R OSD LEVEL	00-63	27
3	OSLG	G OSD LEVEL	00-63	27
4	OSDC		00-03	0
5	OSDB	B OSD LEVEL	00-63	27

DEVICE "S/W ADKB"

Item#	OSD	DETAIL	Range (DEC)	Initial Data
1	SRIL	S/W AKB RED OUTPUT Lower	00-255	Soft Cont'l
2	SRIH	S/W AKB RED OUTPUT Upper	00-01	Soft Cont'l
3	SGIL	S/W AKB GREEN OUTPUT Lower	00-255	Soft Cont'l
4	SGIH	S/W AKB GREEN OUTPUT Upper	00-01	Soft Cont'l
5	SBIL	S/W AKB BLUE OUTPUT Lower	00-255	Soft Cont'l
6	SBIH	S/W AKB BLUE OUTPUT Upper	00-01	Soft Cont'l
7	SLM1	S/W AKB LIMIT DATA 1	00-255	4
8	SLM2	S/W AKB LIMIT DATA 2	00-255	29
9	SLM3	S/W AKB LIMIT DATA 3	00-255	130
10	SAD1	S/W AKB ADD DATA 1	00-255	1
11	SAD2	S/W AKB ADD DATA 2	00-255	1
12	SBIT	S/W AKB BIT SHIFT DATA	00-05	0
13	SNOP	S/W AKB POWER ON NOP TIMER COUNTER DATA	00-FF	1
14	SERL	S/W AKB BIT ERROR JUDGE LEVEL	01-80	124
15	SPWC	S/W AKB ERROR JUDGE COUNTER DATA	01-FF	2
16	SLMC	S/W AKB LIM2/LIM3 JUDGE COUNTER DATA	01-FF	10
17	SPWL	S/W AKB POWER ON MUTE OFF JUDGE LEVEL	01-80	30
18	SPMT	S/W AKB POWER ON MUTE EXIT TIMER DATA(@100ms)	00-FF	120
19	SEEP	S/W AKB INITIAL DATA EEPROM WRITE TIMER(@1sec)	00-FF	20

ADJUSTMENT ITEMS (8 OF 8)

DEVICE "AUDIO PROCESSOR"

Item#	OSD	DETAIL	Range (DEC)	Initial Data
1	SBAL	Sub Balance	00-07	4
2	SBAS	Sub Bass	00-07	0
3	STRE	Sub Treble	00-07	0
4	SRL	Surround Level	00-01	0
5	BBOL	Surround Off-BBE Low	00-15	0
6	BBOH	Surround Off-BBE High	00-15	3
7	BBSL	Simulate BBE Low	00-15	0
8	BBSH	Simulate BBE High	00-15	0
9	BBGL	WOW Game BBE Low	00-15	7
10	BBGH	WOW Game BBE High	00-15	3
11	BBTL	SRS BBE Low	00-15	0
12	BBTH	SRS BBE High	00-15	2
13	VFIX	Audio output fix data	00-255	240
14	AGCL	AGC level	00-03	2

DEVICE "MICROPROCESSOR"

Item#	OSD	DETAIL	Range (DEC)	Initial Data
1	DISP	OSD horizontal offset	00-127	78
2	CCHP	Closed Caption Horizontal Position	00-7E	80
3	HRLW	Low limit of H-pulse counting window (RF)	00-255	16
4	HRHG	High limit of H-pulse counting window (RF)	00-255	64
5	HSLW	Low limit of H-pulse counting window (S-Video)	00-255	16
6	HSHG	High limit of H-pulse counting window (S-Video)	00-255	64
7	HSDT	H-pulse Detection(S-Video)	00-255	8

DEVICE "FEATURE"

Item#	OSD	DETAIL	Range (DEC)	Initial Data
	ID0	Language related	00-255	SEE ID MAP
	ID1	Video related	00-255	SEE ID MAP
	ID2	Audio related	00-255	SEE ID MAP
	ID3	Miscellaneous	00-255	SEE ID MAP
	ID4	Miscellaneous	00-255	SEE ID MAP
	ID5	Miscellaneous	00-255	SEE ID MAP
	ID6	Miscellaneous	00-255	SEE ID MAP
	ID7	Miscellaneous	00-255	SEE ID MAP

Notes:

Range (DEC) shows the range of possible setting for each Adjustment Mode.
Initial Data shows the standard settings for each Adjustment Mode.

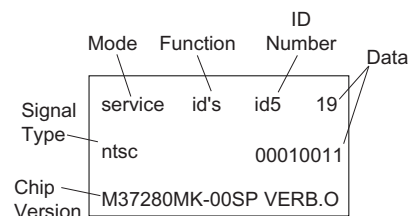

4-4. ID MAP TABLE

Model	Destination	ID-0	ID-1	ID-2	ID-3	ID-4	ID-5	ID-6	ID-7
KV-20FS100	US	89	7	65	33	128	48	0	150
KV-20FS100	CND	89	7	65	49	128	48	0	150
KV-20FV300	US	89	23	231	35	128	48	0	150
KV-20FV300	CND	89	23	231	51	128	48	0	150
KV-21FS100	E	81	7	81	129	160	48	0	214
KV-21FM100	E	81	3	64	129	160	16	0	198
KV-21FV300	E	81	23	231	131	160	48	0	214
KV-24FV300	US	89	23	231	35	128	48	0	150
KV-24FV300	CND	89	23	231	51	128	48	0	150
KV-25FV300	E	81	23	231	131	160	48	0	214

4-5. A BOARD ADJUSTMENTS

H. FREQUENCY (FREE RUN) CHECK

1. Input a TV mode (RF) with no signal.
2. Connect a frequency counter to base of Q502 (TP-25 H. DRIVE) on the A Board.
3. Check H. Frequency for 15735 ± 200 Hz.

V. FREQUENCY (FREE RUN) CHECK

1. Select video 1 with no signal input.
2. Set the conditions for a standard setting.
3. Connect the frequency counter to TP-27 (V OUT) or CN515 pin ⑥ (V DY+) and ground on the A Board .
4. Check that V. Frequency shows 60 ± 4 Hz.

DRIVE (SCON)

1. Input a color-bar signal and set the level to 75%.
2. Set in Standard mode.
3. Activate the Service Adjustment Mode.
4. Set AALS, ABLs, GON and BON items. Using ③ and ⑥ set each to the following values. Leave RON set to "1".

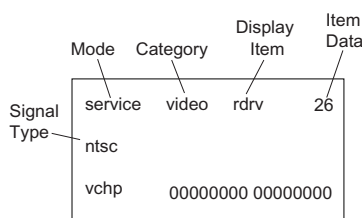

AALS: OFF (0)
ABLS: OFF (1)
R ON: ON (1)
G ON: OFF (0)
B ON: OFF (0)

5. Connect an oscilloscope probe to CV Board, J1751Pin 12 (KR) (Red Out) .
6. Select SCON with ① and ④ .
7. Adjust the value of SCON with ③ and ⑥ for $86 \pm 3V_{pp}$ for 20/21 inch and $96 \pm 3V_{pp}$ for 24/25 inch.

$86 \pm 3V_{pp}$ for 20 inch and
 $96 \pm 3V_{pp}$ for 24 inch.

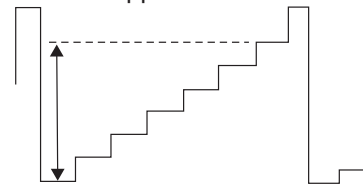

8. Reset AALS, ABLs, GON and BON values to "1".
AALS: ON (1)
ABLS: ON (0)
R ON: ON (1)
G ON: ON (1)
B ON: ON (1)
9. Press [MUTING] then [ENTER] to save into the memory.

DISPLAY POSITION ADJUSTMENT (DISP)

1. Input a color-bar signal.
2. Set to Service Adjustment Mode.
3. Select DISP with ① and ④ .
4. Adjust values of DISP with ③ and ⑥ to adjust characters to the center.
5. Write to memory by pressing [MUTING] then [ENTER] .
6. Check to see if the text is displayed on the screen.

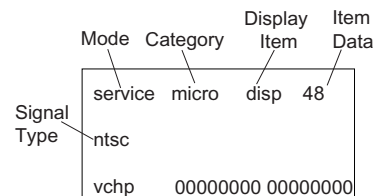

SUB BRIGHT ADJUSTMENT (SBRT)

1. Input a monoscope signal.
2. Activate the Service Adjustment Mode.
3. Set the PICTURE and BRIGHTNESS to minimum.
4. Select the SBRT item with ① and ④ .
5. Adjust the values of SBRT with ③ and ⑥ to obtain a faintly visible crosshatch.
6. Press [MUTING] then [ENTER] to save into the memory.

SUB HUE, SUB COLOR ADJUSTMENT (SHUE, SCOL)

1. Input color-bar signal at 75%.
2. Activate the Service Adjustment Mode.
3. Set (PIC) to Max and (COL) to 50%.
4. Connect an oscilloscope probe to CV Board, CN301Pin ④ Blue Out.
5. Select the SHUE and SCOL item with ① and ④ .
6. While showing the SHUE item, adjust the waveform with ① and ④ until the second and third bars show the same level ($V_2 = V_3 < 0.15V_{p-p}$). Set Sub Hue -2 Step.

- While showing the SCOL item, adjust the waveform with **[3]** and **[6]** until the first and fourth bars show the same level ($V1 = V4 < 0.15Vp-p$). Set Sub Col +2 Step.

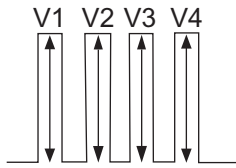

- Press **[MUTING]** then **[ENTER]** to save into the memory.

V. SIZE ADJUSTMENT (VSIZ)

- Input a crosshatch signal.
- Activate the Service Adjustment Mode.
- Select the VSIZ item with **[1]** and **[4]**.
- Adjust value of VPOS with **[1]** and **[4]** for the best vertical center.
- Press **[MUTING]** then **[ENTER]** to save into the memory.

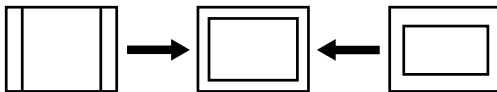

V. CENTER ADJUSTMENT (VPOS)

Perform this adjustment after performing H. Frequency (Free Run) Check.

- Input a crosshatch signal.
- Activate the Service Adjustment Mode.
- Select the VPOS item with **[1]** and **[4]**.
- Adjust value of VPOS with **[3]** and **[6]** for the best vertical center.
- Press **[MUTING]** then **[ENTER]** to save into the memory.

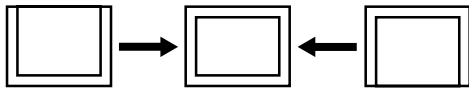

H. CENTER ADJUSTMENT (HPOS)

Perform this adjustment after performing H. Frequency (Free Run) Check.

- Input a crosshatch signal.
- Activate the Service Adjustment Mode.
- Select the HPOS item with **[1]** and **[4]**.
- Adjust the value of HPOS with **[3]** and **[6]** for the best horizontal center.
- Press **[MUTING]** then **[ENTER]** to save into the memory.

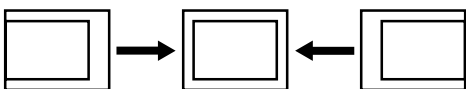

H. SIZE ADJUSTMENT (HSIZ)

- Input a monoscope signal.
- Activate the Service Adjustment Mode.
- Select HSIZ with **[1]** and **[4]**.
- Adjust with **[3]** and **[6]** for the best horizontal size.
- Press **[MUTING]** then **[ENTER]** to save into the memory.

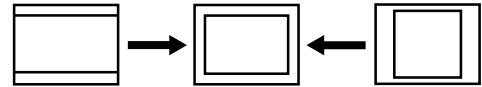

V. LINEARITY (VLIN), V. CORRECTION (SCOR), PIN AMP (PAMP), AND HORIZONTAL TRAPEZOID (HTRP) ADJUSTMENTS

- Input a crosshatch signal.
- Activate the Service Adjustment Mode.
- Select VLIN, SCOR, PAMP, and HTRP with with **[1]** and **[4]**.
- Adjust with **[3]** and **[6]** for the best horizontal size.
- Press **[MUTING]** then **[ENTER]** to save into the memory.

V LINEARITY (VLIN)

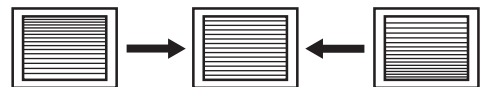

V CORRECTION (SCOR)

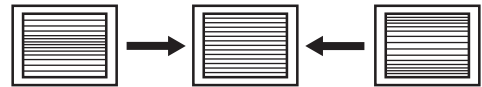

PIN AMP (PAMP)



HORIZONTAL TRAPEZOID (HTRP)



V. ANGLE (VANG), V. BOW (VBOW), UPPER PIN (UPIN) AND LOW PIN (LPIN) ADJUSTMENTS

1. Input a crosshatch signal.
2. Activate the Service Adjustment Mode.
3. Select VANG, VBOW, UPIN, and LPIN with **1** and **4**.
4. Adjust with **3** and **6** for the best picture.
5. Press **MUTING** then **ENTER** to save into the memory.

V ANGLE (VANG)

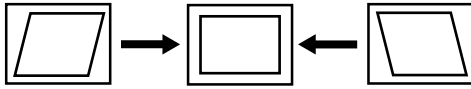

V BOW (VBOW)

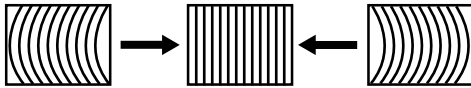

UPPER PIN (UPIN)

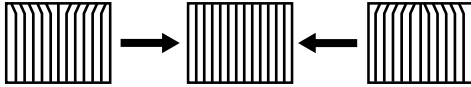

LOW PIN (LPIN)

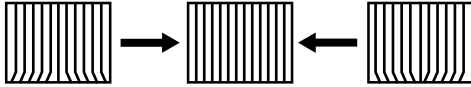

SERVICE ADJUSTMENT MODE MEMORY

1. After completing all adjustments, press **0** then **ENTER**.

Read From Memory

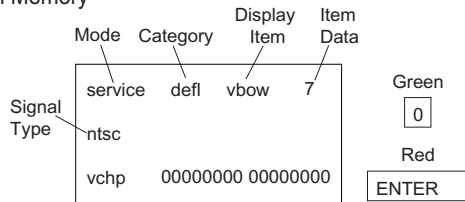

SECTION 5: DIAGRAMS

5-1. CIRCUIT BOARDS LOCATION

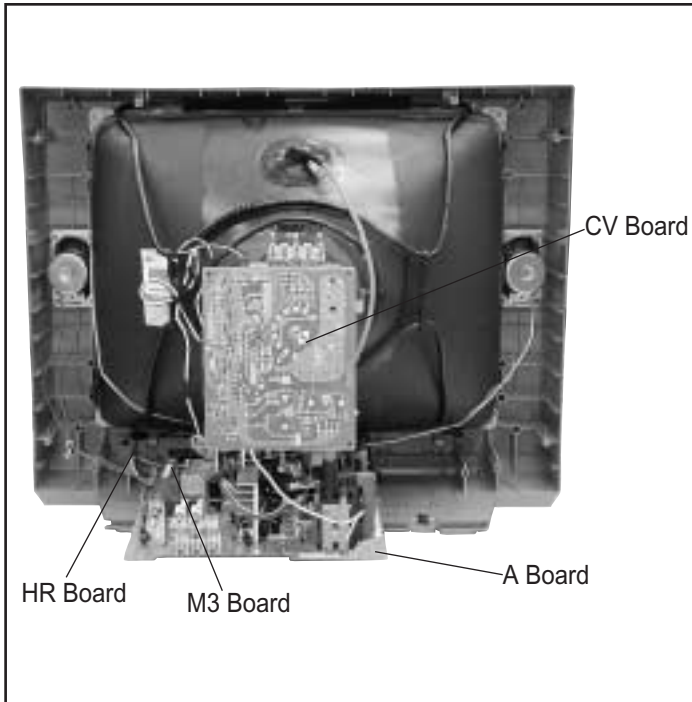

The components identified by in this basic schematic diagram have been carefully factory-selected for each set in order to satisfy regulations regarding X-ray radiation. Should replacement be necessary, replace only with the value originally used.

When replacing components identified by , make the necessary adjustments as indicated. If the results do not meet the specified value, change the component identified by and repeat the adjustment until the specified value is achieved. (Refer to Safety Related Adjustments on Page 15.)

When replacing the parts listed in the table below, it is important to perform the related adjustments.

Part Replaced ()	Adjustment ()
DY, T585, CRT, IC001, IC561, C507, C508, C506, T511, L510, C588, L588, C566, C561, C563, D567, D568, D566, R567, R568, R565, R566, R562, R563, R561, R528.....A Board	HV HOLD-DOWN R565

5-2. PRINTED WIRING BOARD AND SCHEMATIC DIAGRAM INFORMATION

All capacitors are in μF unless otherwise noted. pF : μF 50VV or less are not indicated except for electrolytics and tantalums.

All electrolytics are in 50V unless otherwise specified.

All resistors are in ohms. k=1000, M=1000k

Indication of resistance, which does not have one for rating electrical power, is as follows: Pitch : 5mm Rating electrical power : $\frac{1}{4}$ W

$\frac{1}{4}$ W in resistance, $\frac{1}{10}$ W and $\frac{1}{8}$ W in chip resistance.

: nonflammable resistor.

: fusible resistor.

: internal component.

: panel designation and adjustment for repair.

All variable and adjustable resistors have characteristic curve B, unless otherwise noted.

Readings are taken with a color-bar signal input.

Readings are taken with a 10M digital multimeter.

Voltages are DC with respect to ground unless otherwise noted.

Voltage variations may be noted due to normal production tolerances.

All voltages are in V.

S : Measurement impossibility.

: B-line. (Actual measured value may be different).

: signal path. (RF)

Circled numbers are waveform references.

REFERENCE INFORMATION

RESISTOR	: RN : RC : FPRD : FUSE : RW : RS : RB :	METAL FILM SOLID NONFLAMMABLE CARBON NONFLAMMABLE FUSIBLE NONFLAMMABLE WIREWOUND NONFLAMMABLE METAL OXIDE NONFLAMMABLE CEMENT ADJUSTMENT RESISTOR
COIL	: LF-8L	MICRO INDUCTOR
CAPACITOR	: TA : PS : PP : PT : MPS : MPP : ALB : ALT : ALR	TANTALUM STYROL POLYPROPYLENE MYLAR METALIZED POLYESTER METALIZED POLYPROPYLENE BIPOLAR HIGH TEMPERATURE HIGH RIPPLE

The components identified by shading and symbol are critical for safety. Replace only with part number specified.

The symbol indicates a fast operating fuse and is displayed on the component side of the board. Replace only with fuse of the same rating as marked.

Les composants identifiés par un trame et une marque sont critiques pour la sécurité. Ne les remplacer que par une pièce portant le numéro spécifié.

Le symbole indique une fusible à action rapide. Doit être remplacé par une fusible de même valeur, comme marqué.

5.3 BLOCK DIAGRAM AND SCHEMATICS
BLOCK DIAGRAM

KV-21FS100/21FM100/21FV300/20FV300/
 20FS100/24FV300/25FV300

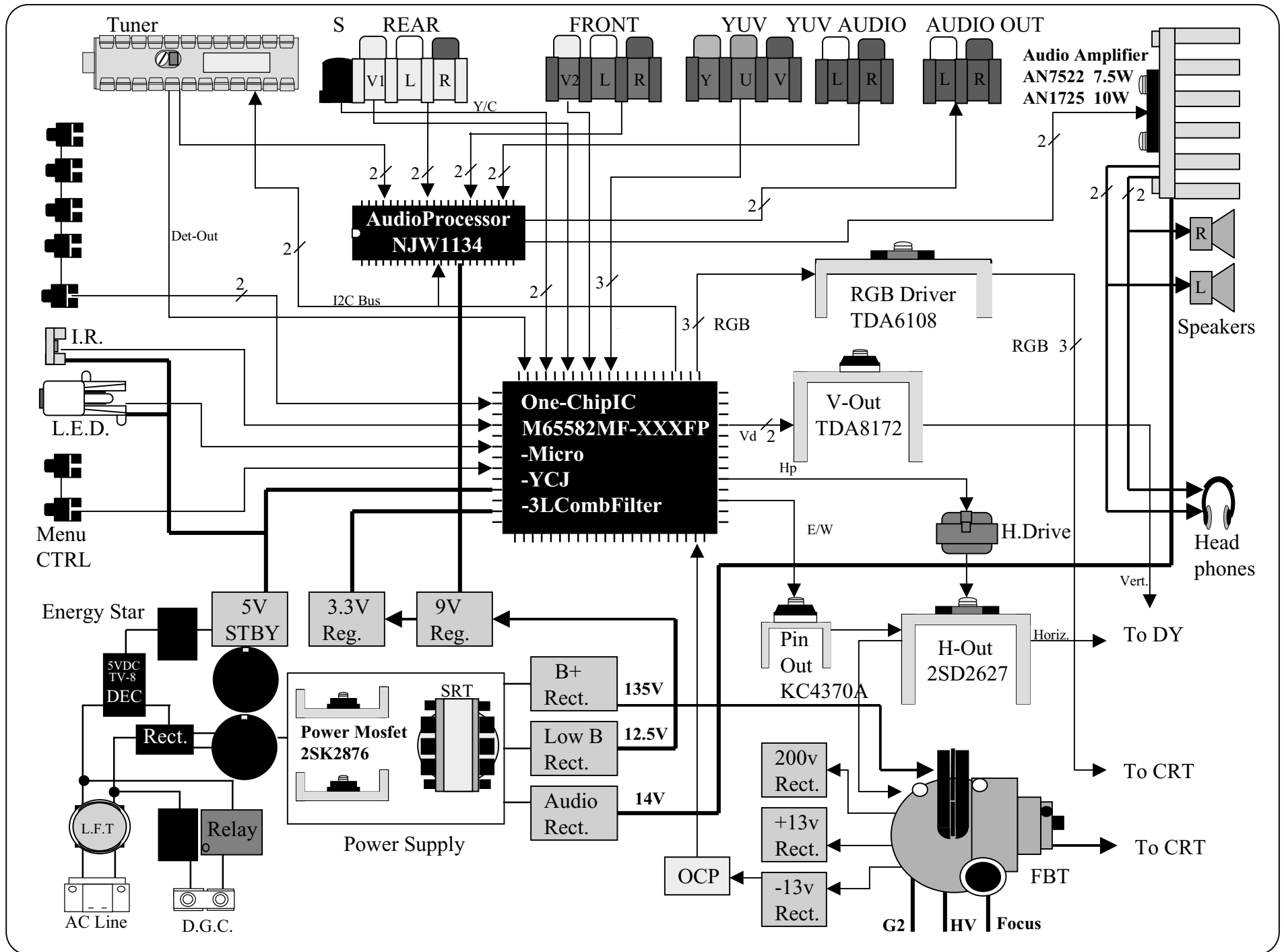

A BOARD SCHEMATIC DIAGRAM

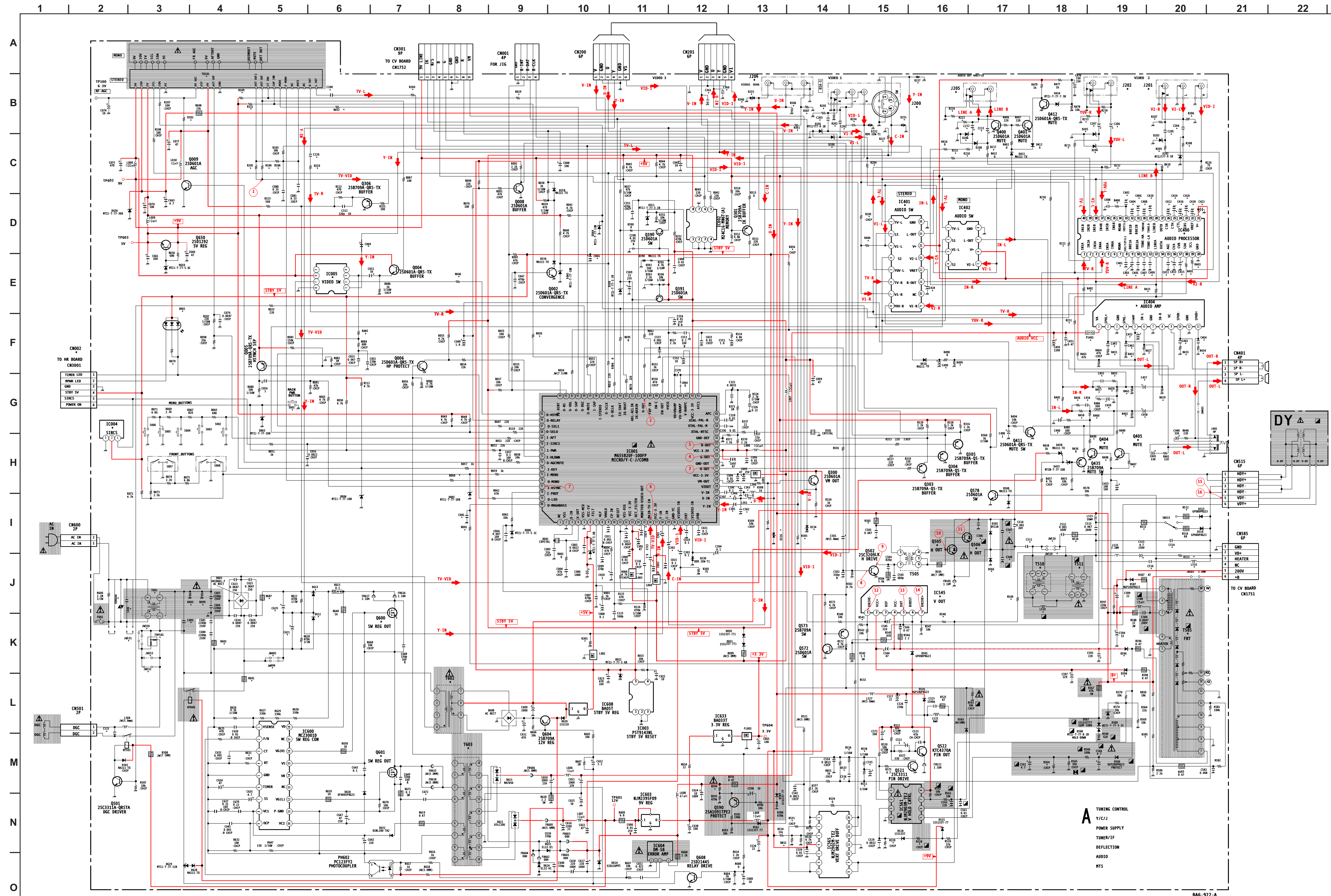

- A TUNING CONTROL
- Y/C/I
- POWER SUPPLY
- TUNER/IF
- DEFLECTION
- AUDIO
- NTS

BA6-922-A

A

[POWER SUPPLY, DEFLECTION, TUNER/IF, AUDIO, MTS, TUNING CONTROL, Y-C JUNGLE]

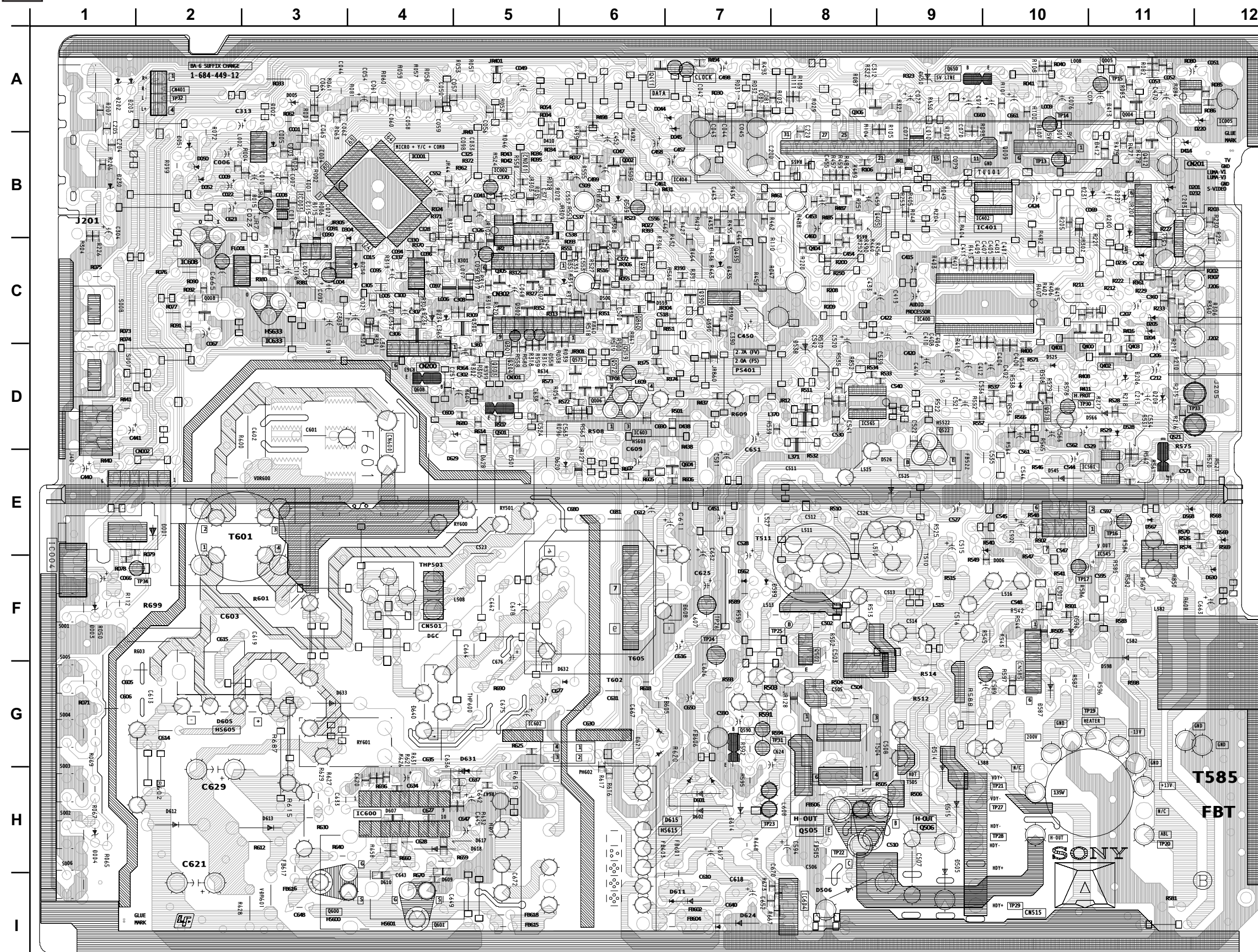

A BOARD LOCATOR TABLE

DIODE		D412	B11	D613	H3
D001	E2	D413	A11	D614	H7
D002	B3	D414	B11	D615	H7
D003	F1	D501	E5	D618	H5
D004	H1	D505	I9	D620	E6
D005	A3	D506	I8	D621	G6
D006	F10	D508	D10	D624	I7
D044	A6	D509	C6	D628	E5
D045	B7	D514	H9	D629	E4
D050	B2	D515	H10	D630	F12
D051	B2	D525	D10	D631	H5
D052	B2	D526	E9	D650	A9
D200	B11	D528	D11	IC	
D201	B11	D545	E10	IC001	B4
D202	A1	D558	D5	IC002	B5
D203	A1	D559	F8	IC003	B3
D204	C11	D562	F7	IC004	F1
D205	C11	D566	D11	IC005	A11
D206	D11	D567	E11	IC400	C9
D208	D11	D568	E11	IC401	B9
D230	B1	D569	F12	IC402	B9
D231	B11	D587	G10	IC404	B7
D232	B11	D589	F8	IC545	E10
D234	C5	D596	F10	IC561	E11
D235	C11	D598	F11	IC565	D8
D236	C4	D601	H7	IC600	H4
D237	B11	D602	H7	IC603	D6
D351	C6	D605	G3	IC604	I8
D390	C7	D608	F7	IC608	C2
D410	B5	D611	I7	IC633	C3
D411	G7	D612	H2		

TRANSISTORS		Q390	C7	Q522	E9
Q002	B6	Q391	C6	Q572	D6
Q004	A11	Q400	C10	Q573	D6
Q005	A11	Q401	C10	Q578	D10
Q006	D6	Q404	C8	Q590	G7
Q008	C2	Q405	C8	Q600	I3
Q009	B10	Q411	A6	Q601	I4
Q300	C5	Q412	B11	Q604	E7
Q301	D5	Q501	D5	Q650	A9
Q303	D5	Q502	G8	Q860	C6
Q304	D5	Q505	H8		
Q305	C5	Q506	H9		
Q306	A8	Q521	D11		

A BOARD TRANSISTOR VOLTAGE LIST

	B	C	E		B	C	E
Q002	0.0	2.0	GND	Q411	0.0	5.8	GND
Q004	3.8	9.0	4.4	Q412	0.1	0.1	GND
Q005	5.1	0.8	5.0	Q435	0.0	GND	5.8
Q006	0.0	0.0	GND	Q501	0.0	14.3	GND
Q008	0.0	2.6	GND	Q502	0.0	74.1	GND
Q009	0.0	5.2	GND	Q505	0.0	131.8	0.0
Q300	1.8	9.0	2.4	Q506	0.0	131.8	0.0
Q301	3.6	2.1	3.6	Q519	1.1	5.0	1.6
Q303	3.6	GND	2.8	Q521	0.0	3.8	GND
Q304	3.6	GND	2.9	Q522	0.1	-2.1	0.0
Q305	3.6	GND	3.0	Q572	0.0	2.6	GND
Q306	5.5	GND	4.9	Q573	2.6	0.0	2.6
Q390	0.8	1.5	1.9	Q578	0.0	0.5	GND
Q391	0.6	3.3	1.5	Q590	133.7	0.0	134.2
Q400	0.0	0.1	GND	Q604	30.6	11.6	30.2
Q401	0.0	0.1	GND	Q608	0.0	6.7	GND
Q404	0.0	0.0	GND	Q650	5.8	9.0	5.0
Q405	0.0	0.0	GND	Q860	1.6	GND	3.0

	D	G	S
Q600	157.8	0.0	-4.4
Q601	-4.4	-153.7	-158.4

A BOARD WAVEFORMS

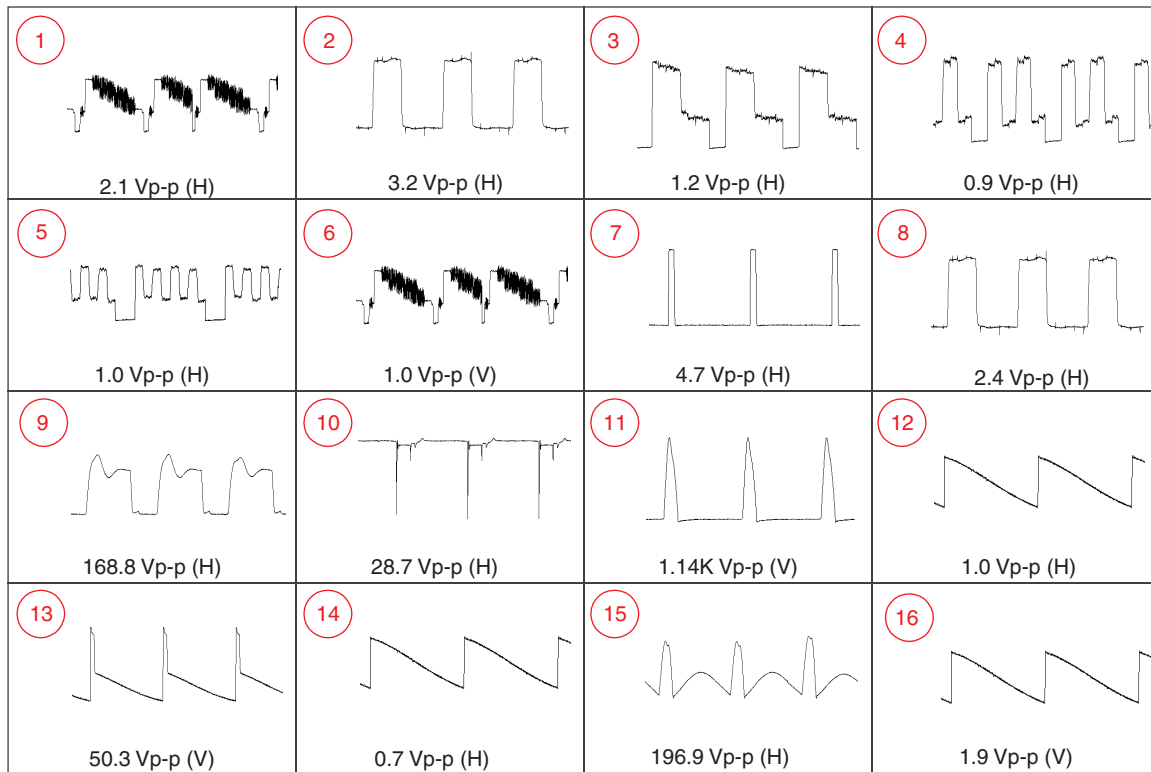

A BOARD IC VOLTAGE LIST

IC001		44	1.6	7	GND	19	4.8	3	4.5	4	9.0	IC608	
PIN	VOLT	45	1.6	8	5.0	20	GND	4	0.4	5	1.0	PIN	VOLT
1	N/C	46	2.3	IC003		21	9.0	5	4.5	6	1.0	I	11.0
2	GND	47	1.0	PIN	VOLT	22	4.5	6	9.0	7	1.0	O	5.0
3	2.2	48	N/C	1	N/C	23	3.8	7	4.4	8	1.6	G	GND
4	2.2	49	0.5	2	GND	24	3.9	8	GND	9	1.6	IC633	
5	GND	50	1.2	3	GND	25	3.9	IC404		10	1.6	PIN	VOLT
6	5.0	51	2.0	4	5.0	26	0.6	PIN	VOLT	11	GND	I	9.0
7	0.0	52	1.5	5	5.0	27	4.5	1	14.6	12	1.6	G	GND
8	2.0	53	4.8	IC004		28	4.5	2	7.0	13	1.6	O	3.3
9	0.3	54	4.8	PIN	VOLT	29	4.5	3	GND	14	1.6		
10	2.1	55	4.8	1	5.0	30	4.5	4	7.0	IC600			
11	5.0	56	4.8	2	5.0	31	4.5	5	5.9	PIN	VOLT		
12	GND	57	N/C	3	GND	32	4.5	6	0.0	1	-155.0		
13	3.3	58	5.2	IC005		33	4.5	7	GND	2	-156.0		
14	3.1	59	0.0	PIN	VOLT	34	N/C	8	0.0	3	-155.0		
15	1.0	60	0.0	1	4.4	35	N/C	9	0.5	4	-155.0		
16	1.5	61	0.0	2	4.9	36	N/C	10	7.2	5	-158.0		
17	3.3	62	0.0	3	4.6	37	4.5	11	GND	6	-158.0		
18	0.5	63	1.4	4	N/C	38	4.5	12	7.0	7	-151.0		
19	1.1	64	4.9	5	N/C	39	4.5	IC545		8	-134.0		
20	GND	65	4.9	6	9.0	40	4.5	PIN	VOLT	9	-158.0		
21	0.5	66	0.0	7	3.9	IC401		1	0.7	10	-147.0		
22	1.7	67	0.1	8	GND	PIN	VOLT	2	13.5	11	-158.0		
23	0.5	68	0.1	IC400		1	4.5	3	-12.2	12	-153.0		
24	0.5	69	2.4	PIN	VOLT	2	0.3	4	-13.3	13	N/C		
25	0.5	70	5.0	1	4.5	3	4.5	5	0.2	14	6.0		
26	0.0	71	5.0	2	4.5	4	0.3	6	13.8	15	-4.4		
27	0.0	72	0.1	3	4.5	5	4.5	7	0.7	16	0.0		
28	2.1	73	0.0	4	4.5	6	4.5	IC561		17	N/C		
29	2.7	74	5.0	5	N/C	7	0.0	PIN	VOLT	18	158.0		
30	3.3	75	5.0	6	N/C	8	4.5	1	0.1	IC603			
31	2.9	76	5.0	7	N/C	9	4.5	2	3.4	PIN	VOLT		
32	GND	77	0.1	8	4.5	10	N/C	3	2.3	I	12.0		
33	2.8	78	0.0	9	4.5	11	4.4	4	GND	G	GND		
34	3.3	79	4.9	10	4.5	12	0.0	5	9.2	O	9.0		
35	2.9	80	4.9	11	4.5	13	4.5	6	10.2	IC604			
36	GND	IC002		12	4.5	14	9.0	7	0.1	PIN	VOLT		
37	1.8	PIN	VOLT	13	4.5	15	4.4	8	13.5	1	133.7		
38	0.0	1	GND	14	4.5	16	GND	IC565		2	N/C		
39	0.1	2	GND	15	0.6	IC402		PIN	VOLT	3	2.5		
40	2.0	3	GND	16	3.5	PIN	VOLT	1	3.4	4	11.3		
41	1.6	4	GND	17	3.5	1	4.5	2	3.4	5	GND		
42	3.3	5	4.8	18	4.8	2	0.3	3	2.1				
43	N/C	6	4.8										

A BOARD IC BLOCK DIAGRAMS
(KV-20FS100/21FM100/21FS100 ONLY)

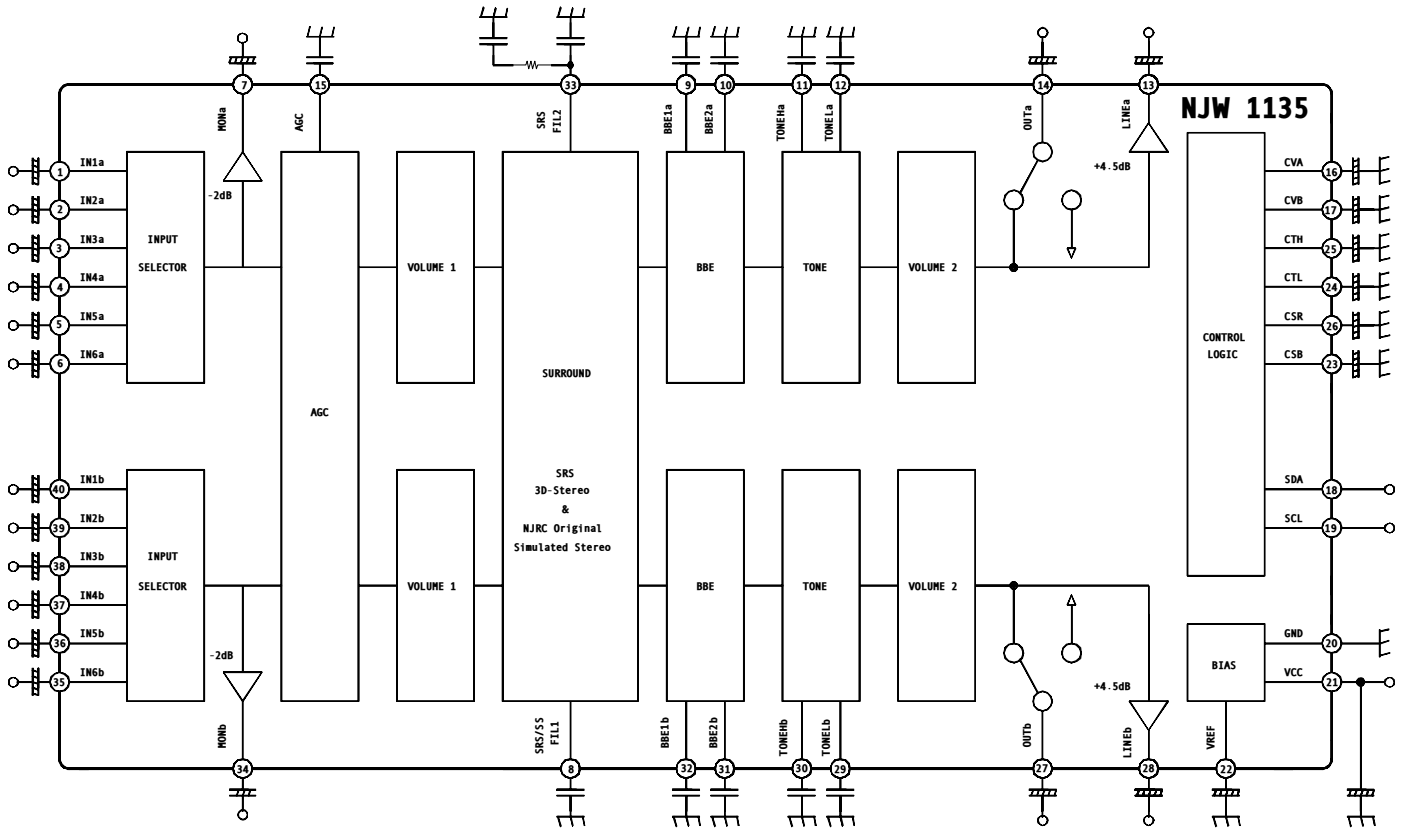

(KV-20FV300/21FV300/24FV300/25FV300 ONLY)

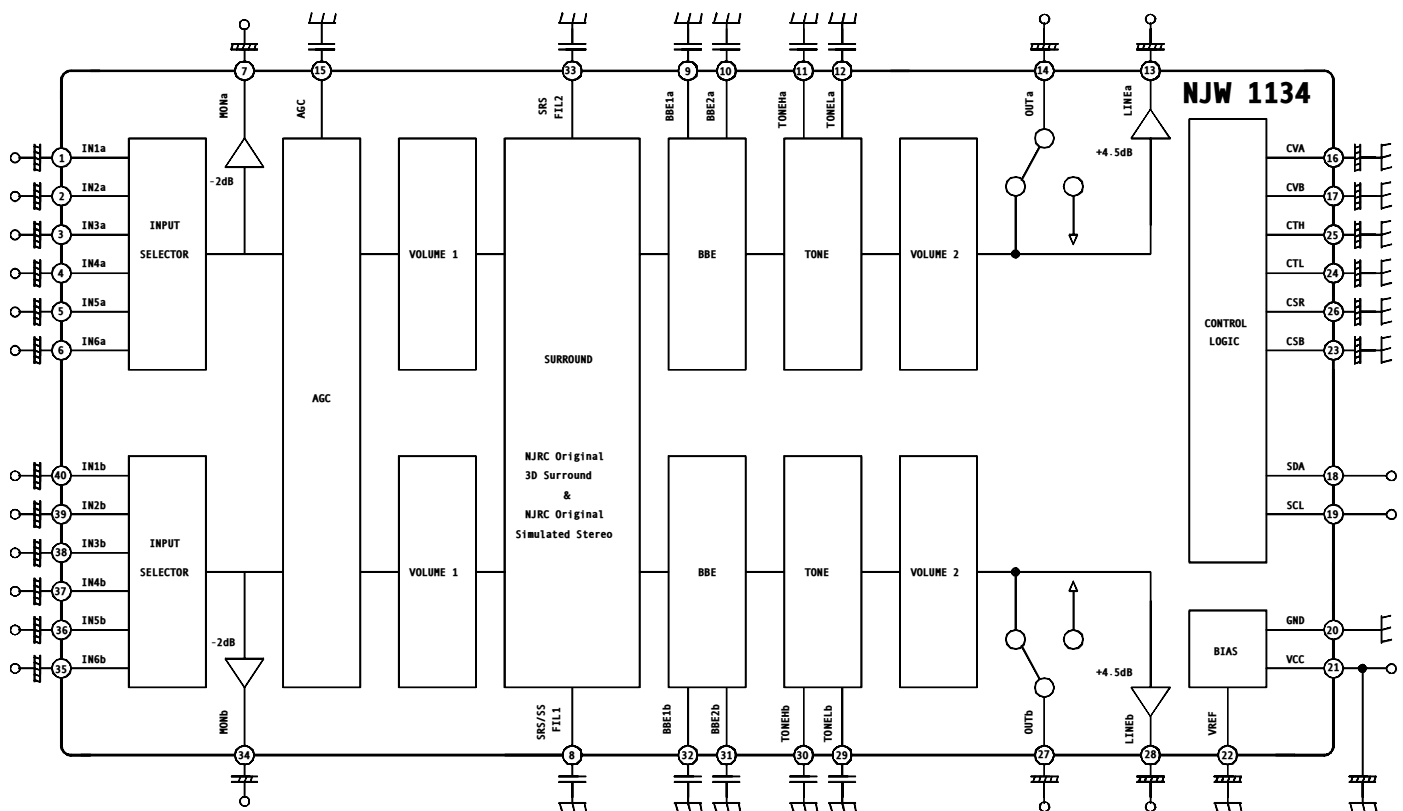

A BOARD VARIANCE TABLE (1 OF 5)

REF. NO.	LOCATION	KV-20FS100(U/C KV-21FS100(N))	KV-21FS100(S)	KV-20FV300(U/C KV-21FV300(N))	KV-21FV300(S)	KV-24FV300(U/C KV-25FV300(N))	KV-25FV300(S)	KV-21FM100(N)	KV-21FM100(S)
C001	I-8	220pF	220pF	#	#	#	#	220pF	220pF
C066	D-10	47µF	47µF	#	#	#	#	47µF	47µF
C069	D-6	#	#	10µF	10µF	10µF	10µF	#	#
C200	B-6	0.1µF	0.1µF	0.1µF	0.1µF	0.1µF	0.1µF	0.47µF	0.47µF
C202	B-14	0.1µF	0.1µF	0.1µF	0.1µF	0.1µF	0.1µF	#	#
C203	B-14	0.1µF	0.1µF	0.1µF	0.1µF	0.1µF	0.1µF	0.47µF	0.47µF
C204	B-20	0.1µF	0.1µF	0.1µF	0.1µF	0.1µF	0.1µF	0.47µF	0.47µF
C205	B-20	0.1µF	0.1µF	0.1µF	0.1µF	0.1µF	0.1µF	#	#
C206	B-19	4.7µF	4.7µF	4.7µF	4.7µF	4.7µF	4.7µF	#	#
C207	B-18	4.7µF	4.7µF	4.7µF	4.7µF	4.7µF	4.7µF	#	#
C212	B-16	100µF	100µF	4.7µF	4.7µF	4.7µF	4.7µF	100µF	100µF
C213	B-16	100µF	100µF	4.7µF	4.7µF	4.7µF	4.7µF	100µF	100µF
C220	C-5	0.1µF	0.1µF	0.1µF	0.1µF	0.1µF	0.1µF	#	#
C301	I-11	#	#	0.1µF	0.1µF	0.1µF	0.1µF	#	#
C302	I-11	#	#	0.1µF	0.1µF	0.1µF	0.1µF	#	#
C305	I-12	0.1µF	0.1µF	0.1µF	0.1µF	0.1µF	0.1µF	#	#
C306	H-13	0.1µF	0.1µF	0.1µF	0.1µF	0.1µF	0.1µF	#	#
C307	H-13	0.1µF	0.1µF	0.1µF	0.1µF	0.1µF	0.1µF	#	#
C360	B-12	220pF	220pF	220pF	220pF	220pF	220pF	#	#
C361	B-12	220pF	220pF	220pF	220pF	220pF	220pF	#	#
C362	I-13	0.001µF	0.001µF	0.001µF	0.001µF	0.001µF	0.001µF	#	#
C363	H-13	0.001µF	0.001µF	0.001µF	0.001µF	0.001µF	0.001µF	#	#
C370	F-12	0.0068µF	0.0068µF	0.0068µF	0.0068µF	0.01µF	0.01µF	0.0068µF	0.0068µF
C400	C-19	#	#	0.33µF	0.33µF	0.33µF	0.33µF	#	#
C401	D-19	#	#	0.022µF	0.022µF	0.022µF	0.022µF	#	#
C402	C-19	#	#	0.0082µF	0.0082µF	0.0082µF	0.0082µF	#	#
C403	D-19	#	#	0.0033µF	0.0033µF	0.0033µF	0.0033µF	#	#
C404	C-19	#	#	0.0033µF	0.0033µF	0.0033µF	0.0033µF	#	#
C405	D-19	#	#	0.033µF	0.033µF	0.033µF	0.033µF	#	#
C406	C-19	#	#	0.033µF	0.033µF	0.033µF	0.033µF	#	#
C407	D-20	#	#	0.0015µF	0.0015µF	0.0015µF	0.0015µF	#	#
C408	C-20	#	#	0.0015µF	0.0015µF	0.0015µF	0.0015µF	#	#
C409	D-20	#	#	0.22µF	0.22µF	0.22µF	0.22µF	#	#
C410	C-20	#	#	0.22µF	0.22µF	0.22µF	0.22µF	#	#
C411	D-20	#	#	0.33µF	0.33µF	0.33µF	0.33µF	#	#
C412	C-20	#	#	1µF	1µF	1µF	1µF	#	#
C413	D-20	#	#	1µF	1µF	1µF	1µF	#	#
C414	C-20	#	#	2.2µF	2.2µF	2.2µF	2.2µF	#	#
C415	D-20	#	#	1µF	1µF	1µF	1µF	#	#
C416	C-20	#	#	1µF	1µF	1µF	1µF	#	#
C418	C-20	#	#	4.7µF	4.7µF	4.7µF	4.7µF	#	#
C420	C-20	#	#	1µF	1µF	1µF	1µF	#	#
C422	C-20	#	#	1µF	1µF	1µF	1µF	#	#
C424	E-16	1µF	1µF	#	#	#	#	#	#
C452	F-19	100µF	100µF	47µF	47µF	47µF	47µF	100µF	100µF
C454	G-19	0.033µF	0.033µF	#	#	#	#	0.033µF	0.033µF

#: Not Mounted

A BOARD VARIANCE TABLE (2 OF 5)

REF. NO.	LOCATION	KV-20FS10(KV-21FS100(N)	KV-21FS100(S)	KV-20FV30(KV-21FV300(N)	KV-21FV300(S)	KV-24FV30(KV-25FV300(N)	KV-25FV300(S)	KV-21FM100(N)	KV-21FM100(S)
C455	F-19	0.033µF	0.033µF	#	#	#	#	0.033µF	0.033µF
C457	F-19	0.22µF	0.22µF	4.7µF	4.7µF	4.7µF	4.7µF	0.22µF	0.22µF
C458	G-19	0.22µF	0.22µF	4.7µF	4.7µF	4.7µF	4.7µF	0.22µF	0.22µF
C459	G-19	0.47µF	0.47µF	#	#	#	#	0.47µF	0.47µF
C460	G-18	0.47µF	0.47µF	#	#	#	#	0.47µF	0.47µF
C461	F-19	#	#	0.22µF	0.22µF	0.22µF	0.22µF	#	#
C462	F-19	#	#	0.22µF	0.22µF	0.22µF	0.22µF	#	#
C463	F-20	#	#	0.22µF	0.22µF	0.22µF	0.22µF	#	#
C464	F-20	#	#	0.22µF	0.22µF	0.22µF	0.22µF	#	#
C499	F-16	22µF	22µF	4.7µF	4.7µF	4.7µF	4.7µF	22µF	22µF
C500	G-17	#	#	#	#	0.047µF	0.047µF	#	#
C506	I-17	0.001µF	0.001µF	0.001µF	0.001µF	680pF	680pF	0.001µF	0.001µF
C507	I-17	8200pF	8200pF	8200pF	8200pF	19000pF	19000pF	8200pF	8200pF
C508	I-17	0.047µF	0.047µF	0.047µF	0.047µF	0.056µF	0.056µF	0.047µF	0.047µF
C511	I-17	0.82µF	0.82µF	0.82µF	0.82µF	0.75µF	0.75µF	0.82µF	0.82µF
C514	I-20	0.56µF	0.56µF	0.56µF	0.56µF	0.82µF	0.82µF	0.56µF	0.56µF
C516	I-19	#	#	#	#	0.15µF	0.15µF	#	#
C523	L-2	0.22µF	0.22µF	0.22µF	0.22µF	0.22µF	0.22µF	0.22µF	0.22µF
C535	M-15	#	#	#	#	0.022µF	0.022µF	#	#
C536	M-15	0.001µF	0.001µF	0.001µF	0.001µF	0.0022µF	0.0022µF	0.001µF	0.001µF
C602	J-2	0.47µF	0.47µF	0.47µF	0.47µF	0.47µF	0.47µF	0.47µF	0.47µF
C603	K-3	0.47µF	0.47µF	0.47µF	0.47µF	0.47µF	0.47µF	0.47µF	0.47µF
C621	K-5	390µF	390µF	470µF	470µF	470µF	470µF	390µF	390µF
C629	J-5	390µF	390µF	470µF	470µF	470µF	470µF	390µF	390µF
C672	M-7	15000pF	15000pF	22000pF	22000pF	22000pF	22000pF	15000pF	15000pF
CN002	F-1	#	#	6P	6P	6P	6P	#	#
D001	E-3	LNK0120022G	LNK0120022G	#	#	#	#	LNK0120022G	LNK0120022G
D200	B-14	MTZJ-T-77-9.1B	MTZJ-T-77-9.1B	MTZJ-T-77-9.1B	MTZJ-T-77-9.1B	MTZJ-T-77-9.1B	MTZJ-T-77-9.1B	#	#
D203	B-20	MTZJ-T-77-9.1B	MTZJ-T-77-9.1B	MTZJ-T-77-9.1B	MTZJ-T-77-9.1B	MTZJ-T-77-9.1B	MTZJ-T-77-9.1B	#	#
D204	B-18	MTZJ-T-77-9.1B	MTZJ-T-77-9.1B	MTZJ-T-77-9.1B	MTZJ-T-77-9.1B	MTZJ-T-77-9.1B	MTZJ-T-77-9.1B	#	#
D205	B-18	MTZJ-T-77-9.1B	MTZJ-T-77-9.1B	MTZJ-T-77-9.1B	MTZJ-T-77-9.1B	MTZJ-T-77-9.1B	MTZJ-T-77-9.1B	#	#
D206	C-16	#	#	MTZJ-T-77-9.1B	MTZJ-T-77-9.1B	MTZJ-T-77-9.1B	MTZJ-T-77-9.1B	#	#
D208	B-16	#	#	MTZJ-T-77-9.1B	MTZJ-T-77-9.1B	MTZJ-T-77-9.1B	MTZJ-T-77-9.1B	#	#
D231	B-15	#	#	RD9.1EW-T1	RD9.1EW-T1	RD9.1EW-T1	RD9.1EW-T1	#	#
D234	I-14	RD9.1EW-T1	RD9.1EW-T1	RD9.1EW-T1	RD9.1EW-T1	RD9.1EW-T1	RD9.1EW-T1	#	#
D235	B-13	RD9.1EW-T1	RD9.1EW-T1	RD9.1EW-T1	RD9.1EW-T1	RD9.1EW-T1	RD9.1EW-T1	#	#
D236	I-13	RD9.1EW-T1	RD9.1EW-T1	RD9.1EW-T1	RD9.1EW-T1	RD9.1EW-T1	RD9.1EW-T1	#	#
D237	A-16	#	#	RD9.1EW-T1	RD9.1EW-T1	RD9.1EW-T1	RD9.1EW-T1	#	#
D506	J-17	RGP15GPKG23	RGP15GPKG23	RGP15GPKG23	RGP15GPKG23	RU4AM-T3	RU4AM-T3	RGP15GPKG23	RGP15GPKG23
D596	K-19	GP08DPKG23	GP08DPKG23	GP08DPKG23	GP08DPKG23	RGP15GPKG23	RGP15GPKG23	GP08DPKG23	GP08DPKG23
D598	K-19	GP08DPKG23	GP08DPKG23	GP08DPKG23	GP08DPKG23	RGP15GPKG23	RGP15GPKG23	GP08DPKG23	GP08DPKG23
D612	J-5	ERC04-06SE	#	ERC04-06SE	#	ERC04-06SE	#	ERC04-06SE	#
D613	J-5	ERC04-06SE	#	ERC04-06SE	#	ERC04-06SE	#	ERC04-06SE	#
F601	K-2	6.3A/125V	6.3A/250V	6.3A/125V	6.3A/250V	6.3A/125V	6.3A/250V	6.3A/125V	6.3A/250V
IC004	G-2	SBX3081-71	SBX3081-71	#	#	#	#	SBX3081-71	SBX3081-71
IC005	E-6	#	#	NJM2534M(TE2)	NJM2534M(TE2)	NJM2534M(TE2)	NJM2534M(TE2)	#	#
IC400	D-20	#	#	NJW1134G-TE2	NJW1134G-TE2	NJW1134G-TE2	NJW1134G-TE2	#	#

#: Not Mounted

A BOARD VARIANCE TABLE (3 OF 5)

REF. NO.	LOCATION	KV-20FS10(KV-21FS100(N)	KV-21FS100(S)	KV-20FV30(KV-21FV300(N)	KV-21FV300(S)	KV-24FV30(KV-25FV300(N)	KV-25FV300(S)	KV-21FM100(N)	KV-21FM100(S)
IC401	D-15	NJM2750M-TE2	NJM2750M-TE2	#	#	#	#	#	#
IC402	D-16	#	#	#	#	#	#	NJM2521M-TE1	NJM2521M-TE1
IC404	E-19	AN17820A	AN17820A	AN7125Z	AN7125Z	AN7125Z	AN7125Z	AN17820A	AN17820A
IC545	J-16	AN5522	AN5522	AN5522	AN5522	TDA8172	TDA8172	AN5522	AN5522
J200	B-15	#	#	#	#	4P	4P	2P	2P
J201	B-19	3P	3P	3P	3P	3P	3P	2P	2P
J202	B-19	#	#	#	#	2P	2P	#	#
J205	B-16	#	#	#	#	2P	2P	#	#
J206	B-13	#	#	#	#	3P	3P	#	#
L360	H-13	10UH	10UH	10UH	10UH	10UH	10UH	#	#
L361	H-13	10UH	10UH	10UH	10UH	10UH	10UH	#	#
L510	J-18	470UH	470UH	470UH	470UH			470UH	470UH
L516	I-20	#	#	#	#	150UH	150UH	#	#
PS401	F-18	1-576-336-21	1-576-336-21	1-576-337-21	1-576-337-21	1-576-337-21	1-576-337-21	1-576-336-21	1-576-336-21
Q404	G-19	2SD601A-QRS-TX	2SD601A-QRS-TX	#	#	#	#	2SD601A-QRS-TX	2SD601A-QRS-TX
Q405	G-19	2SD601A-QRS-TX	2SD601A-QRS-TX	#	#	#	#	2SD601A-QRS-TX	2SD601A-QRS-TX
Q505	I-16	#	#	#	#	2SD2634-YB	2SD2634-YB	#	#
Q506	I-17	2SD2627LS-YB11	2SD2627LS-YB11	2SD2627LS-YB11	2SD2627LS-YB11	#	#	2SD2627LS-YB11	2SD2627LS-YB11
Q600	J-7	2SK2876-01MR-F122	2SK2876-01MR-F122	2SK2640-01MR-F122	2SK2640-01MR-F122	2SK2640-01MR-F122	2SK2640-01MR-F122	2SK2876-01MR-F122	2SK2876-01MR-F122
Q601	M-6	2SK2876-01MR-F122	2SK2876-01MR-F122	2SK2640-01MR-F122	2SK2640-01MR-F122	2SK2640-01MR-F122	2SK2640-01MR-F122	2SK2876-01MR-F122	2SK2876-01MR-F122
R001	I-8	220	220	#	#	#	#	220	220
R029	B-9	220	220	220	220	220	220	#	#
R030	F-9	220	220	220	220	220	220	#	#
R032	B-6	220	220	220	220	220	220	#	#
R036	D-13	4.7K	4.7K	2.2K	2.2K	2.2K	2.2K	4.7K	4.7K
R046	E-8	#	#	220	220	220	220	#	#
R060	H-8	220	220	220	220	220	220	#	#
R079	F-3	0	0	#	#	#	#	0	0
R085	F-6	0	0	#	#	#	#	0	0
R101	B-3	4.7K	4.7K	4.7K	4.7K	4.7K	4.7K	8.2K	8.2K
R104	C-4	#	#	#	#	#	#	0	0
R105	C-4	0	0	0	0	0	0	#	#
R106	C-5	#	#	#	#	#	#	0	0
R109	B-4	4.7K	4.7K	4.7K	4.7K	4.7K	4.7K	#	#
R111	B-4	4.7K	4.7K	4.7K	4.7K	4.7K	4.7K	#	#
R200	B-7	47K	47K	220	220	220	220	47K	47K
R202	B-14	100K	100K	100K	100K	100K	100K	#	#
R203	B-14	100K	100K	100K	100K	100K	100K	470K	470K
R204	C-14	47K	47K	220	220	220	220	47K	47K
R205	D-15	47K	47K	#	#	#	#	47K	47K
R206	B-20	100K	100K	100K	100K	100K	100K	470K	470K
R207	B-19	100K	100K	100K	100K	100K	100K	#	#
R208	B-20	47K	47K	220	220	220	220	47K	47K
R209	B-20	47K	47K	220	220	220	220	47K	47K
R210	B-18	100K	100K	100K	100K	100K	100K	#	#
R211	B-18	47K	47K	220	220	220	220	47K	47K

#: Not Mounted

A BOARD VARIANCE TABLE (4 OF 5)

REF. NO.	LOCATION	KV-20FS10(KV-21FS100(N)	KV-21FS100(S)	KV-20FV30(KV-21FV300(N)	KV-21FV300(S)	KV-24FV30(KV-25FV300(N)	KV-25FV300(S)	KV-21FM100(N)	KV-21FM100(S)
R212	C-19	47K	47K	220	220	220	220	47K	47K
R213	B-18	100K	100K	100K	100K	100K	100K	#	#
R215	B-16	#	#	100K	100K	100K	100K	#	#
R216	B-16	#	#	100K	100K	100K	100K	#	#
R217	B-17	#	#	220	220	220	220	#	#
R218	C-16	#	#	220	220	220	220	#	#
R220	C-5	47K	47K	220	220	220	220	47K	47K
R221	D-18	#	#	220	220	220	220	#	#
R222	C-16	#	#	220	220	220	220	#	#
R227	B-15	#	#	75	75	75	75	#	#
R234	B-15	#	#	#	#	#	#	#	#
R250	C-18	#	#	22K	22K	22K	22K	#	#
R251	E-18	#	#	22K	22K	22K	22K	#	#
R301	K-10	#	#	75	75	75	75	#	#
R305	I-14	75	75	75	75	75	75	#	#
R306	B-13	75	75	75	75	75	75	#	#
R307	B-14	75	75	75	75	75	75	#	#
R360	B-12	100	100	100	100	100	100	#	#
R361	B-13	100	100	100	100	100	100	#	#
R400	C-19	#	#	4.7K	4.7K	4.7K	4.7K	#	#
R401	D-20	#	#	100	100	100	100	#	#
R403	D-20	#	#	100	100	100	100	#	#
R404	E-14	#	#	#	#	#	#	0	0
R405	G-18	#	#	#	#	#	#	0	0
R410	B-20	0	0	#	#	#	#	0	0
R413	D-20	0	0	#	#	#	#	0	0
R427	F-19	#	#	4.7K	4.7K	4.7K	4.7K	#	#
R429	F-20	#	#	4.7K	4.7K	4.7K	4.7K	#	#
R431	F-19	#	#	2.2	2.2	2.2	2.2	#	#
R432	F-19	#	#	2.2	2.2	2.2	2.2	#	#
R433	F-20	#	#	2.2	2.2	2.2	2.2	#	#
R434	F-20	#	#	2.2	2.2	2.2	2.2	#	#
R455	F-19	1K	1K	#	#	#	#	1K	1K
R456	G-18	1K	1K	#	#	#	#	1K	1K
R457	F-19	1K	1K	#	#	#	#	1K	1K
R458	G-18	1K	1K	#	#	#	#	1K	1K
R459	F-19	470	470	#	#	#	#	470	470
R460	G-19	470	470	#	#	#	#	470	470
R461	F-19	2.2K	2.2K	100K	100K	100K	100K	1K	1K
R462	G-19	2.2K	2.2K	100K	100K	100K	100K	1K	1K
R482	E-18	#	#	#	#	#	#	#	#
R487	H-19	22K	22K	#	#	#	#	22K	22K
R488	H-19	22K	22K	#	#	#	#	22K	22K
R489	G-19	47	47	#	#	#	#	47	47
R490	G-19	47	47	#	#	#	#	47	47
R499	F-16	2.2K	2.2K	10K	10K	10K	10K	2.2K	2.2K

#: Not Mounted

CV BOARD SCHEMATIC DIAGRAM

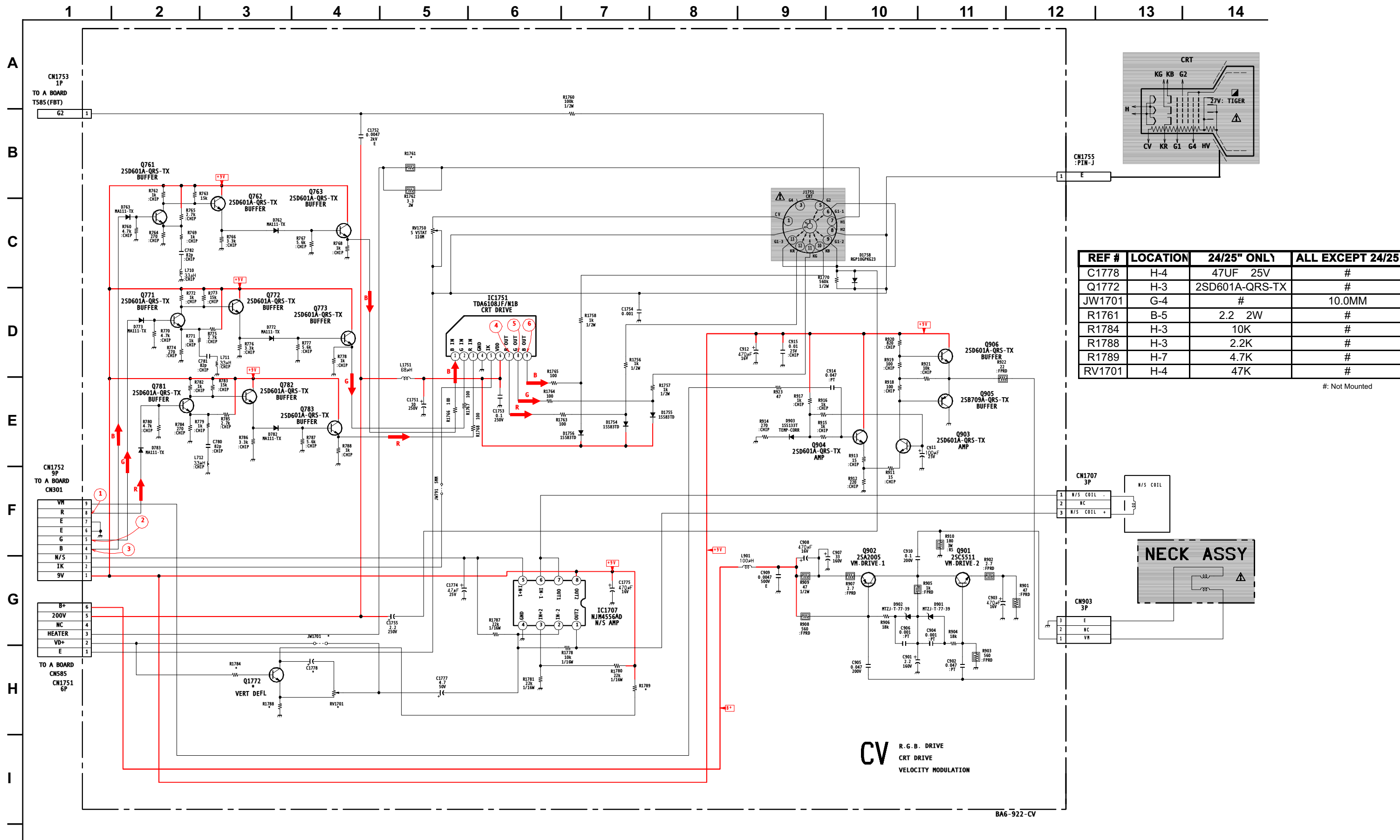

CV BOARD WAVEFORMS

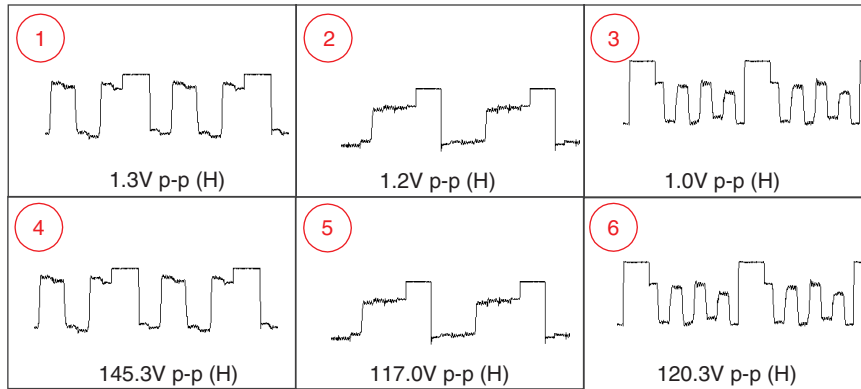

CV [RGB DRIVE, CRT DRIVE, VELOCITY MODULATION]

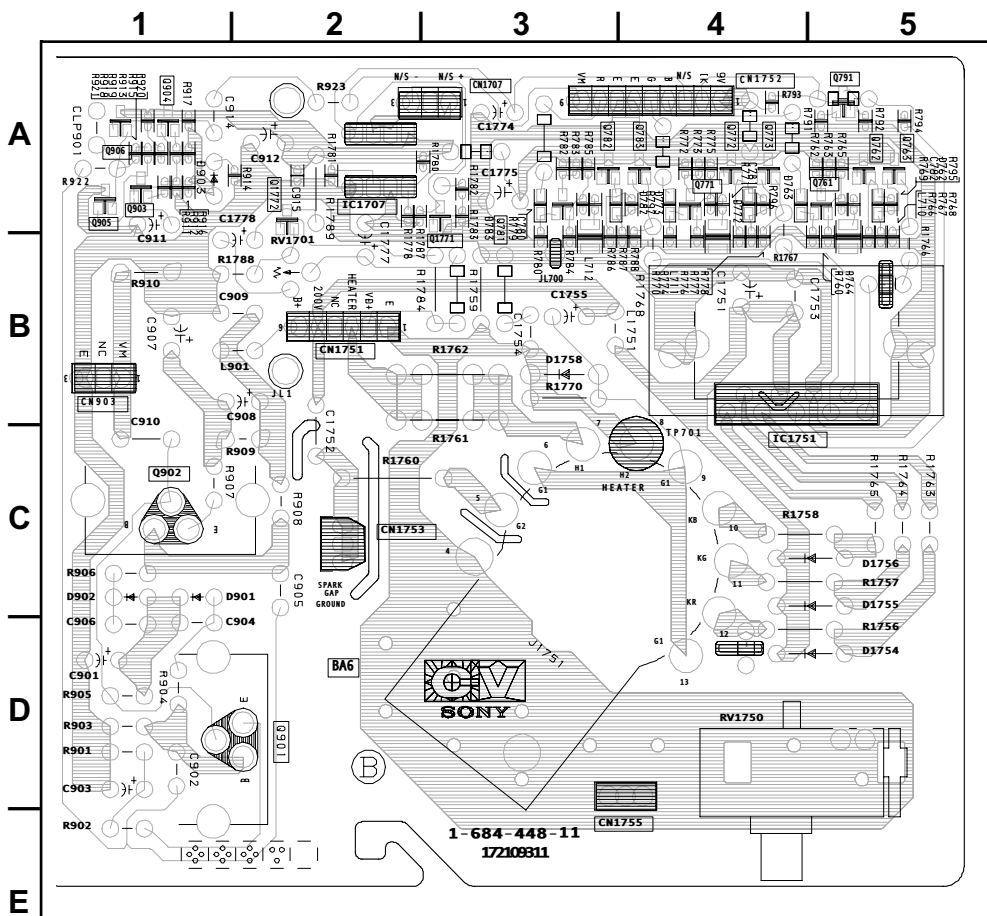

CV BOARD IC VOLTAGE TABLE

IC1707	
PIN	VOLT
1	1.8
2	2.8
3	4.4
4	GND
5	4.8
6	4.8
7	4.8
8	9.0

IC1751	
PIN	VOLT
1	2.0
2	2.0
3	2.4
4	GND
5	3.7
6	200.0
7	136.0
8	142.0
9	140.0

CV BOARD TRANSISTOR TABLE

	B	C	E		B	C	E
Q761	2.2	3.8	2.9	Q783	2.1	9.0	2.7
Q762	3.1	9.0	3.8	Q901	0.9	67.0	0.4
Q763	2.0	9.0	2.6	Q902	134.0	67.0	134.0
Q771	2.2	3.8	2.9	Q903	1.8	5.4	2.4
Q772	3.2	9.0	3.8	Q904	1.8	9.0	2.4
Q773	2.0	9.0	2.6	Q905	5.7	GND	5.4
Q781	2.2	3.9	2.9	Q906	5.7	9.0	6.1
Q782	3.3	9.0	3.9	Q1772	0.0	0.0	0.0

HR BOARD SCHEMATIC DIAGRAM

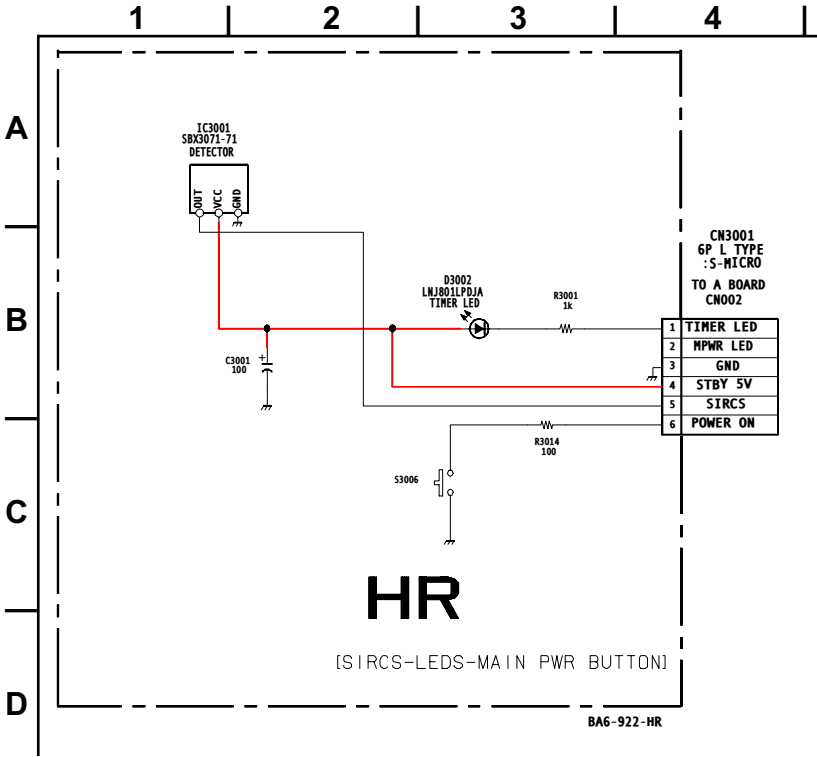

HR [MAIN PWR BUTTON, SIRCS, LEDS]

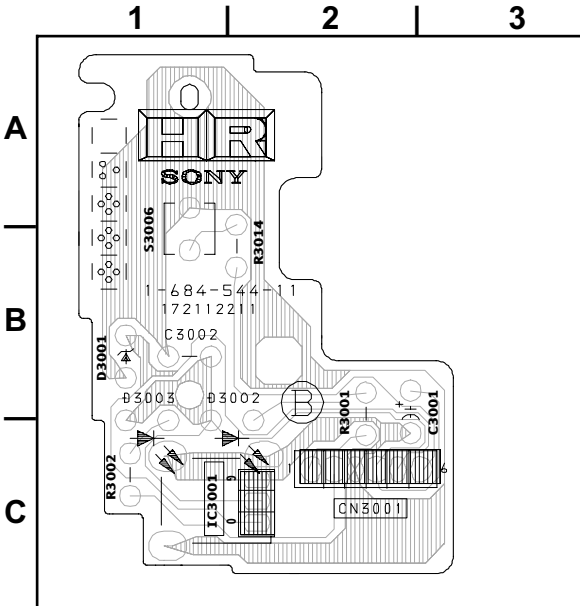

M3 BOARD SCHEMATIC DIAGRAM

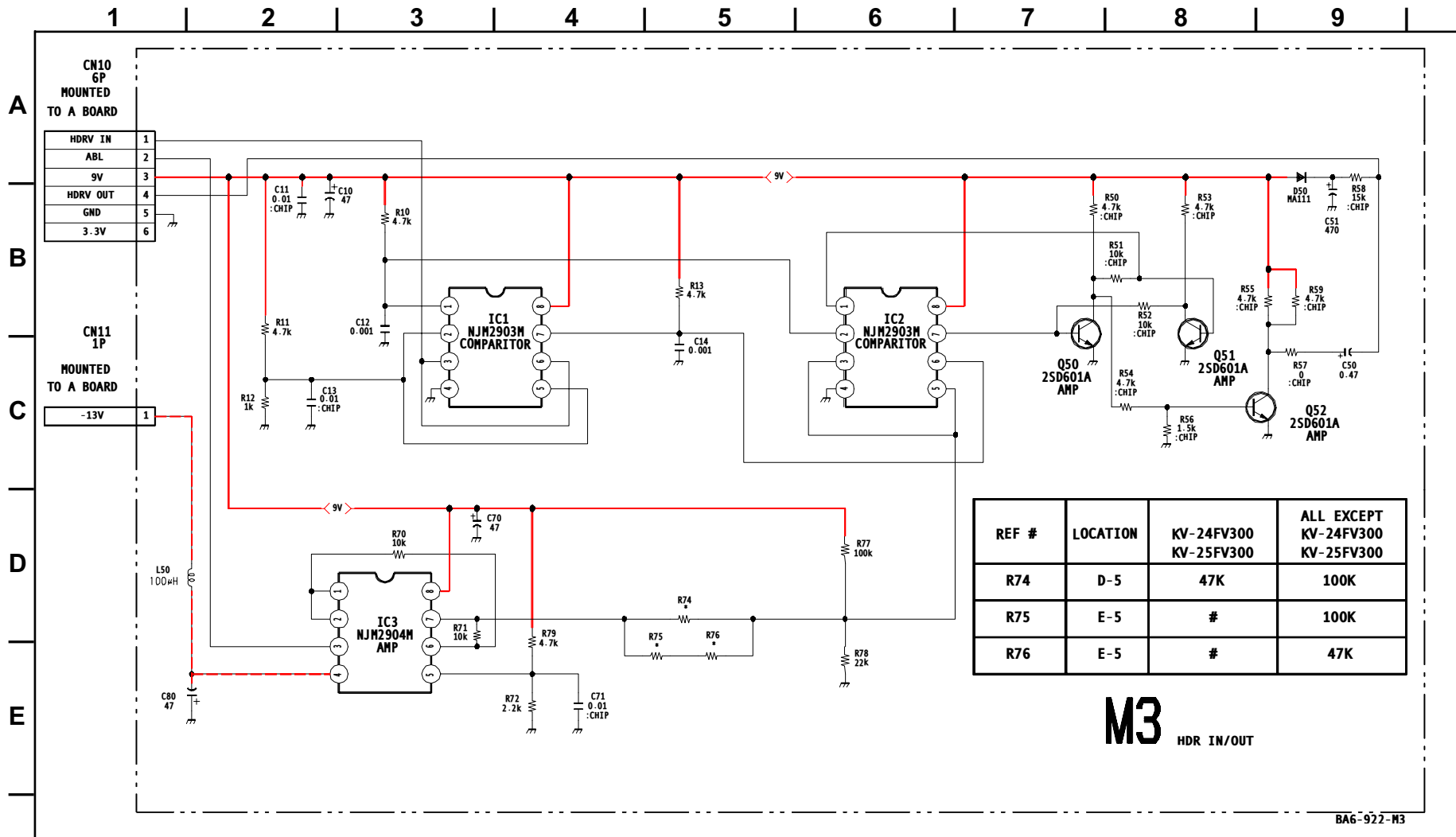

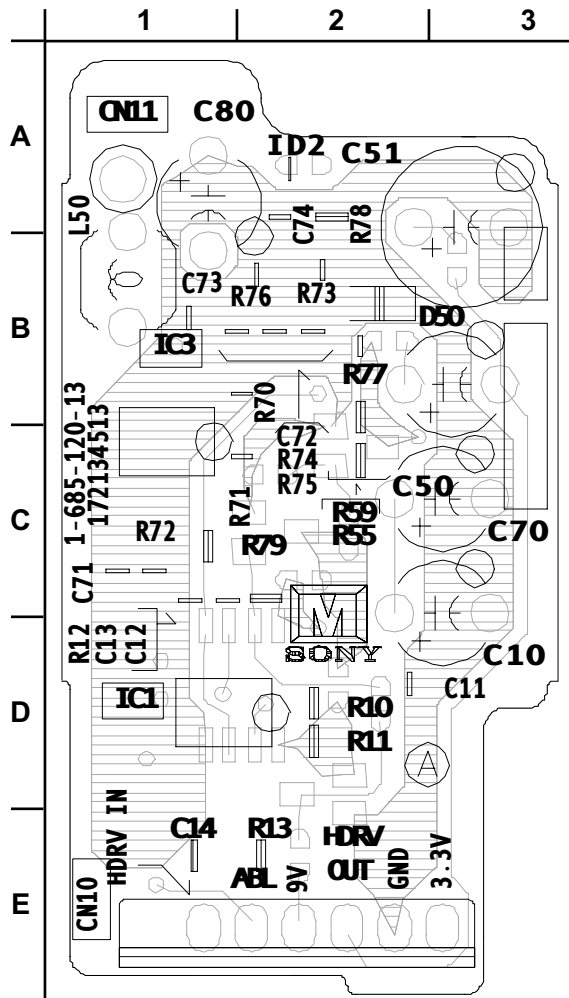

M3 [HDR IN/OUT CONDUCTOR SIDE]

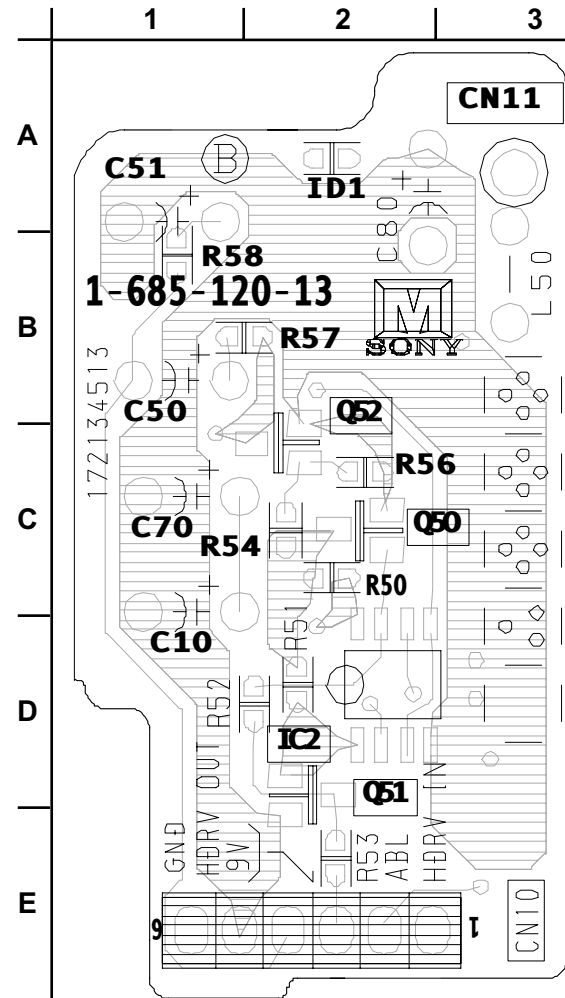

M3 [HDR IN/OUT COMPONENT SIDE]

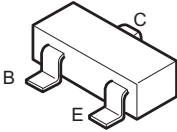
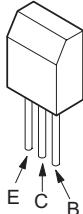
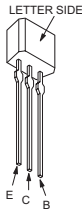
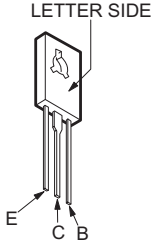
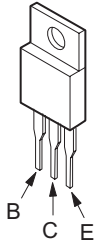
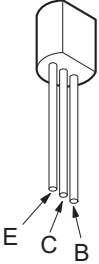
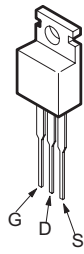
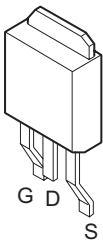
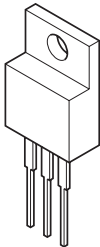
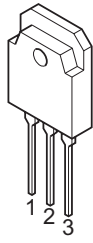
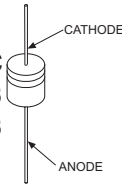
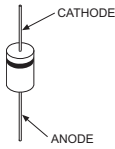
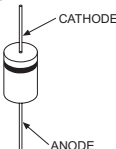

5-4. SEMICONDUCTORS

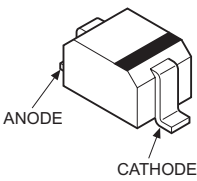
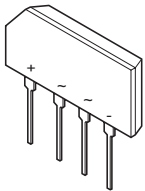
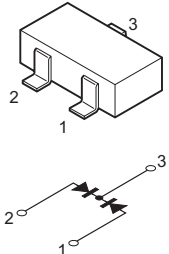
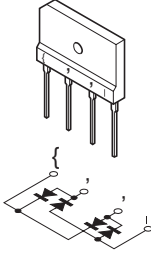
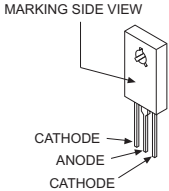
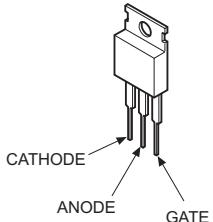
<p>2SB709A-QRS-TX 2SD601A-QRS-TX</p> 	<p>2SB734-T-34 2SC3209LK-TP</p> 	<p>2SA1309A-QRSTA 2SC3311A-QRSTA 2SD2144S-TP-UVV</p> 	<p>2SC3840K</p> 	<p>2SA1837</p> 
<p>2SA10910-TPE2</p> 	<p>IRF614</p> 	<p>2SK2663</p> 	<p>2SC4793</p> 	<p>2SD2578-YB</p> 
<p>ERA38-06TP1 ERA82-004TP5 1SS133T-77 D1NS0R-TA MTZJ-T-77-12C MTZJ-T-77-15B MTZJ-T-77-33B MTZJ-T-77-39</p> 	<p>RU-1P ERC06-15S EGP20DPKG23 MTZJ-T-77-5.1C MTZJ-T-77-5.6C MTZJ-T-77-7.5A MTZJ-T-77-10B MTZJ-T-77-30D RGP10-GPKG3 RGP02-17PKG23</p> 	<p>ERB44-06TP1 1SS83TD GP08DPKG23 RGP10GPKG23 RU4AM-T3</p> 	<p>RD9.1EW-T1</p> 	<p>MA111-TX UDZ-TE-17.5.1B UDZ-TE-17.91B</p> 
<p>D2SB60A-F04</p> 	<p>DAP202K-T-146</p> 	<p>D4SB60L-F</p> 		
<p>D5LC20U</p> 	<p>TF541M</p> 			

SECTION 6: EXPLODED VIEWS

Components not identified by a part number or description are not stocked because they are seldom required for routine service.

The component parts of an assembly are indicated by the reference numbers in the far right column of the parts list and within the dotted lines of the diagram.

* Items marked with an asterisk are not stocked since they are seldom required for routine service. Expect some delay when ordering these components.

NOTE: The components identified by shading and \triangle mark are critical for safety. Replace only with part number specified.

NOTE: Les composants identifiés par un trame et une marque \triangle sont critiques pour la sécurité. Ne les remplacer que par une pièce portant le numéro spécifié.

6-1. CHASSIS (KV-21FM100 ONLY)

●	7-685-648-79	SCREW +BVTP 3X12 TYPE2 IT-3
■	7-685-663-71	SCREW +BVTP 4X16 TYPE2 IT-3
▲	4-365-808-01	SCREW (5) TAPPING

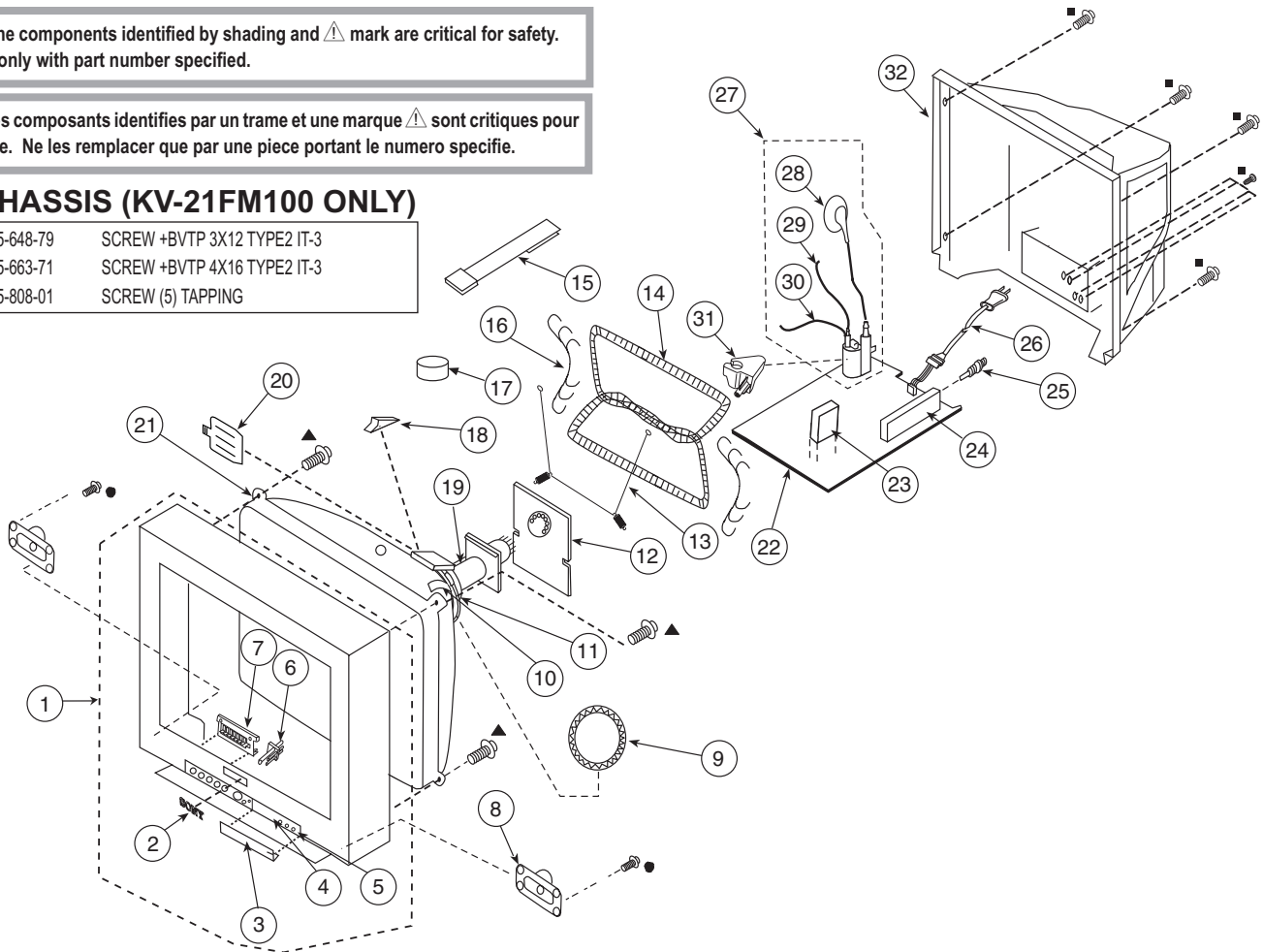

REF. NO.	PART NO.	DESCRIPTION	[Assembly Includes]	REF. NO.	PART NO.	DESCRIPTION	[Assembly Includes]
1	X-4039-907-1	BEZNET ASSY	2-7	* 22	A-1300-147-A	A COMPLETE PC BOARD 21FM100(N) (ONLY)	23
2	4-046-161-11	EMBLEM (NO.8), SONY				The high-voltage leads associated with the FBT on this board are not included and must be ordered separately (SEE 28-30).	
3	4-078-806-51	DOOR		* 22	A-1300-243-A	A COMPLETE PC BOARD 21FM100(S) (ONLY)	23
4	4-074-895-51	LABEL, FRONT TERMINAL (20)				The high-voltage leads associated with the FBT on this board are not included and must be ordered separately (SEE 28-30).	
5	3-703-574-00	RETAINER, DOOR		23	A-1400-738-A	M3 (VAR) MOUNTED PC BOARD	
6	4-073-933-02	GUIDE, LED		\triangle 24	8-598-594-00	TUNER, FSS BTF-FA421	
7	4-073-931-21	BUTTON, MULTI		\triangle 25	1-766-374-11	PLUG, F-PIN	
8	1-529-613-11	SPEAKER (9X5CM)		\triangle 26	1-791-935-12	CORD, AC POWER(WITH CONNECTOR) 21FM100(N) (ONLY)	
\triangle 9	1-452-728-61	COIL, NA ROTATION (RT-154)		\triangle 26	1-769-796-31	CORD, POWER (WITH CONNECTOR) 21FM100(S) (ONLY)	
* 10	4-074-576-01	CUSHION, DGC		\triangle 27	1-453-316-21	FBT ASSY NX-1748//X4A4	28-30
\triangle 11	8-451-505-71	DY Y21RSA-V		\triangle 28	1-251-642-52	CAP ASSY, HIGH-VOLTAGE	
* 12	A-1400-223-A	CV (VAR) MOUNTED PC BOARD		\triangle 29	1-900-800-65	CONNECTOR ASSY, FOCUS LEAD	
* 13	4-375-394-01	SPRING, TENSION		\triangle 30	1-900-803-22	WIRE ASSY, G2 LEAD	
\triangle 14	1-419-287-12	COIL, DEGAUSSING		31	4-071-497-02	HOLDER, FBT	
15	4-083-414-01	PIECE A(110), CONV CORRECT		32	4-087-298-01	COVER, REAR	
* 16	4-080-810-21	BAND, DEGAUSS COIL					
17	1-452-032-00	MAGNET,DISC					
18	4-053-005-01	SPACER, DY					
19	1-451-552-21	NECK ASSEMBLY					
20	4-057-714-01	PIECE ASSY, TLH CORRECTION					
\triangle 21	8-738-831-05	CRT 21RSN(SDP) (A51LPT50X) 21FM100(N) (ONLY)					
\triangle 21	8-738-838-05	CRT 21RSN (SDP) SOUTH (A51LPT50X) 21FM100(S) (ONLY)					

NOTE: The components identified by shading and ⚠ mark are critical for safety. Replace only with part number specified.

NOTE: Les composants identifiés par un trame et une marque ⚠ sont critiques pour la sécurité. Ne les remplacer que par une pièce portant le numéro spécifique.

6-2. CHASSIS (KV-20FS100/21FS100 ONLY)

●	7-685-648-79	SCREW +BVTP 3X12 TYPE2 IT-3
■	7-685-663-71	SCREW +BVTP 4X16 TYPE2 IT-3
▲	4-365-808-01	SCREW (5) TAPPING

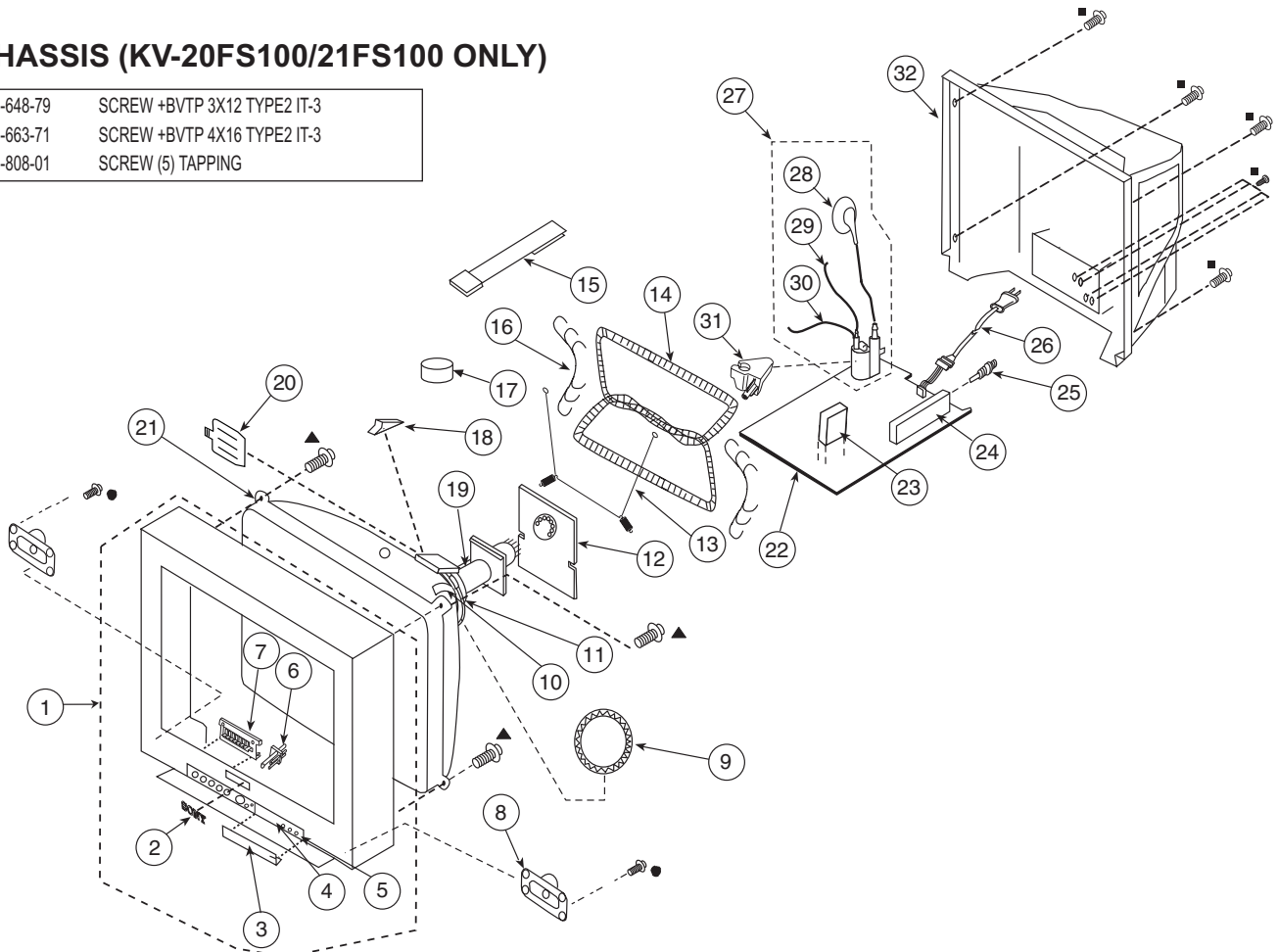

REF. NO.	PART NO.	DESCRIPTION	[Assembly Includes]	REF. NO.	PART NO.	DESCRIPTION	[Assembly Includes]
1	X-4039-906-1	BEZNET ASSY	2-7	* 22	A-1300-242-A	A COMPLETE PC BOARD 21FS100(S) (ONLY)	23
2	4-046-161-11	EMBLEM (NO.8), SONY				The high-voltage leads associated with the FBT on this board are not included and must be ordered separately (SEE 28-30).	
3	4-078-806-51	DOOR		* 22	A-1300-146-A	A COMPLETE PC BOARD 20FS100/21FS100(N) (ONLY)	23
4	4-074-895-41	LABEL, FRONT TERMINAL (20)				The high-voltage leads associated with the FBT on this board are not included and must be ordered separately (SEE 28-30).	
5	3-703-574-00	RETAINER, DOOR		23	A-1400-738-A	M3 (VAR) MOUNTED PC BOARD	
6	4-073-933-02	GUIDE, LED		▲ 24	8-598-593-00	TUNER, FSS BTF-WA421	
7	4-073-931-31	BUTTON, MULTI		▲ 25	1-766-374-11	PLUG, F-PIN	
8	1-825-070-11	SPEAKER (5x9CM)		▲ 26	1-824-069-11	CORD, AC	
8	1-529-613-11	SPEAKER (9X5CM)		▲ 26	1-769-796-31	CORD, AC POWER(WITH CONNECTOR)	
▲ 9	1-452-728-61	COIL, NA ROTATION (RT-154)		▲ 26	1-791-935-12	CORD, AC POWER(WITH CONNECTOR)	
* 10	4-074-576-01	CUSHION, DGC		▲ 27	1-453-316-21	FBT ASSY NX-1748//X4A4	28-30
▲ 11	8-451-505-71	DY Y21RSA-V		▲ 28	1-251-642-52	CAP ASSY, HIGH-VOLTAGE	
* 12	A-1400-223-A	CV (VAR) MOUNTED PC BOARD		▲ 29	1-900-800-65	CONNECTOR ASSY, FOCUS LEAD	
* 13	4-375-394-01	SPRING, TENSION		▲ 30	1-900-803-22	WIRE ASSY, G2 LEAD	
▲ 14	1-419-287-12	COIL, DEGAUSSING		31	4-071-497-02	HOLDER, FBT	
15	4-083-414-01	PIECE A(110), CONV CORRECT		32	4-087-298-01	COVER, REAR	
* 16	4-080-810-21	BAND, DEGAUSS COIL					
17	1-452-032-00	MAGNET,DISC					
18	4-053-005-01	SPACER, DY					
19	1-451-552-21	NECK ASSEMBLY					
20	4-057-714-01	PIECE ASSY, TLH CORRECTION					
▲ 21	8-738-838-05	CRT 21RSN(SDP) (A51LPT50X)					
		21FS100(S) (ONLY)					
▲ 21	8-738-831-05	CRT 21RSN(SDP) (A51LPT50X)					
		20FS100/21FS100(N) (ONLY)					

NOTE: The components identified by shading and ⚠ mark are critical for safety. Replace only with part number specified.

NOTE: Les composants identifiés par un trame et une marque ⚠ sont critiques pour la sécurité. Ne les remplacer que par une pièce portant le numéro spécifique.

6-3. CHASSIS (KV-20FV300/21FV300 ONLY)

- 4-384-096-01 SCREW 4X16 TAPPING, +P
- 7-685-663-79 SCREW +BVTP 4X16 TYPE2 IT(B)
- ▲ 4-365-808-01 SCREW (5) TAPPING
- ★ 7-685-663-91 SCREW

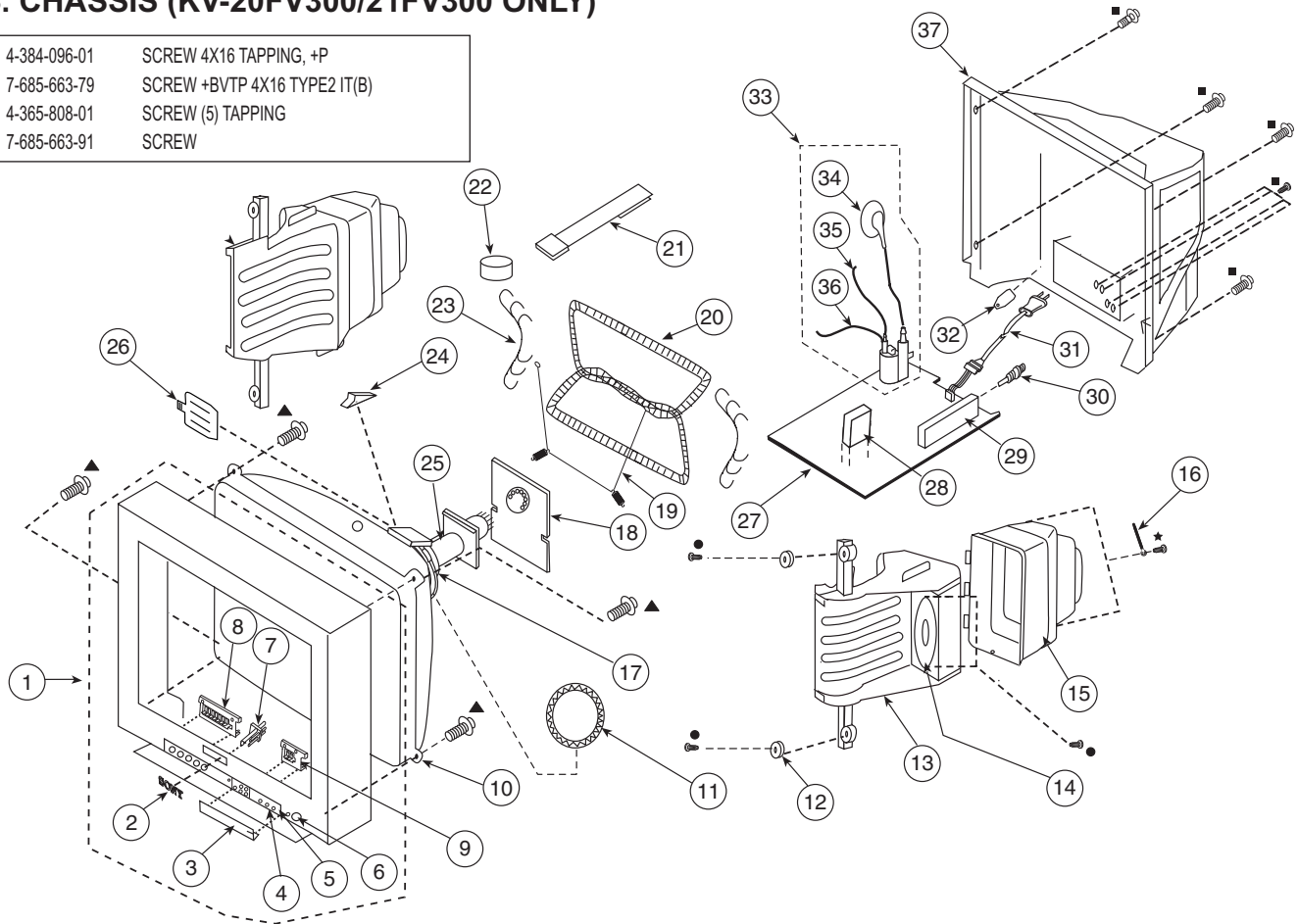

REF. NO.	PART NO.	DESCRIPTION	[Assembly Includes]	REF. NO.	PART NO.	DESCRIPTION	[Assembly Includes]
1	X-4039-877-1	BEZNET ASSY	2-8	24	4-053-005-01	SPACER, DY	
2	4-046-161-11	EMBLEM (NO.8), SONY		25	1-451-552-21	NECK ASSEMBLY	
3	4-087-155-11	DOOR, CONTROL		26	4-057-714-01	PIECE, TLH CONVERGENCE	
4	4-074-895-71	LABEL, FRONT TERMINAL (20)		* 27	A-1300-271-A	A COMPLETE PC BOARD 21FV300(S) (ONLY)	28
5	4-042-192-01	CATCHER, PUSH				The high-voltage leads associated with the FBT on this board are not included and must be ordered separately (SEE 34-36).	
6	4-087-150-01	BUTTON, POWER		* 27	A-1300-156-A	A COMPLETE PC BOARD 20FV300/21FV300(N) (ONLY)	28
7	4-087-156-01	GUIDE, LIGHT				The high-voltage leads associated with the FBT on this board are not included and must be ordered separately (SEE 34-36).	
8	4-087-151-01	BUTTON, MULTI		28	A-1400-738-A	M3 (VAR) MOUNTED PC BOARD	
* 9	A-1400-251-A	HR (COM) MOUNTED PC BOARD		▲ 29	8-598-593-00	TUNER, FSS BTF-WA421	
▲ 10	8-738-838-05	CRT 21RSN(SDP)(SOUTH) (A51LPT50X) 21FV300(S) (ONLY)		▲ 30	1-766-374-11	PLUG, F-PIN	
▲ 10	8-738-831-05	CRT 21RSN(SDP) (A51LPT50X) 20FV300/21FV300(N) (ONLY)		▲ 31	1-757-840-12	CORD, AC POWER (WITH CONNECTOR) 21FV300(S) (ONLY)	
▲ 11	1-452-728-61	COIL, NA ROTATION (RT-154)		▲ 31	1-824-069-11	CORD, AC	
* 12	4-374-745-31	CUSHION (A)		* 32	4-081-980-11	HOLDER, AC CABLE	
13	4-087-154-01	BAFFLE, SPEAKER		▲ 33	1-453-316-21	FBT ASSY NX-1748//X4A4	34-36
14	1-825-069-11	SPEAKER (8CM)		▲ 34	1-251-642-52	CAP ASSY, HIGH-VOLTAGE	
15	4-071-350-01	COVER, SPEAKER		▲ 35	1-900-800-65	CONNECTOR ASSY, FOCUS LEAD	
16	4-857472-01	CLAMP		▲ 36	1-900-803-22	WIRE ASSY, G2 LEAD	
▲ 17	8-451-505-71	DY Y21RSA-V		37	4-087-153-01	COVER, REAR	
* 18	A-1400-223-A	CV (VAR) MOUNTED PC BOARD					
* 19	4-375-394-01	SPRING, TENSION					
▲ 20	1-419-287-12	COIL, DEGAUSSING					
21	4-083-414-01	PIECE A(110), CONV CORRECT					
22	1-452-032-00	MAGNET, DISC					
* 23	4-080-810-21	BAND, DEGAUSS COIL					

NOTE: The components identified by shading and ⚠ mark are critical for safety. Replace only with part number specified.

NOTE: Les composants identifiés par un trame et une marque ⚠ sont critiques pour la sécurité. Ne les remplacer que par une pièce portant le numéro spécifique.

6-4. CHASSIS (KV-24FV300/25FV300 ONLY)

- 4-384-096-01 SCREW 4X16 TAPPING, +P
- 7-685-663-79 SCREW +BVTP 4X16 TYPE2 IT(B)
- ▲ 4-041-268-01 SCREW (7) TAPPING
- ★ 7-685-663-91 SCREW

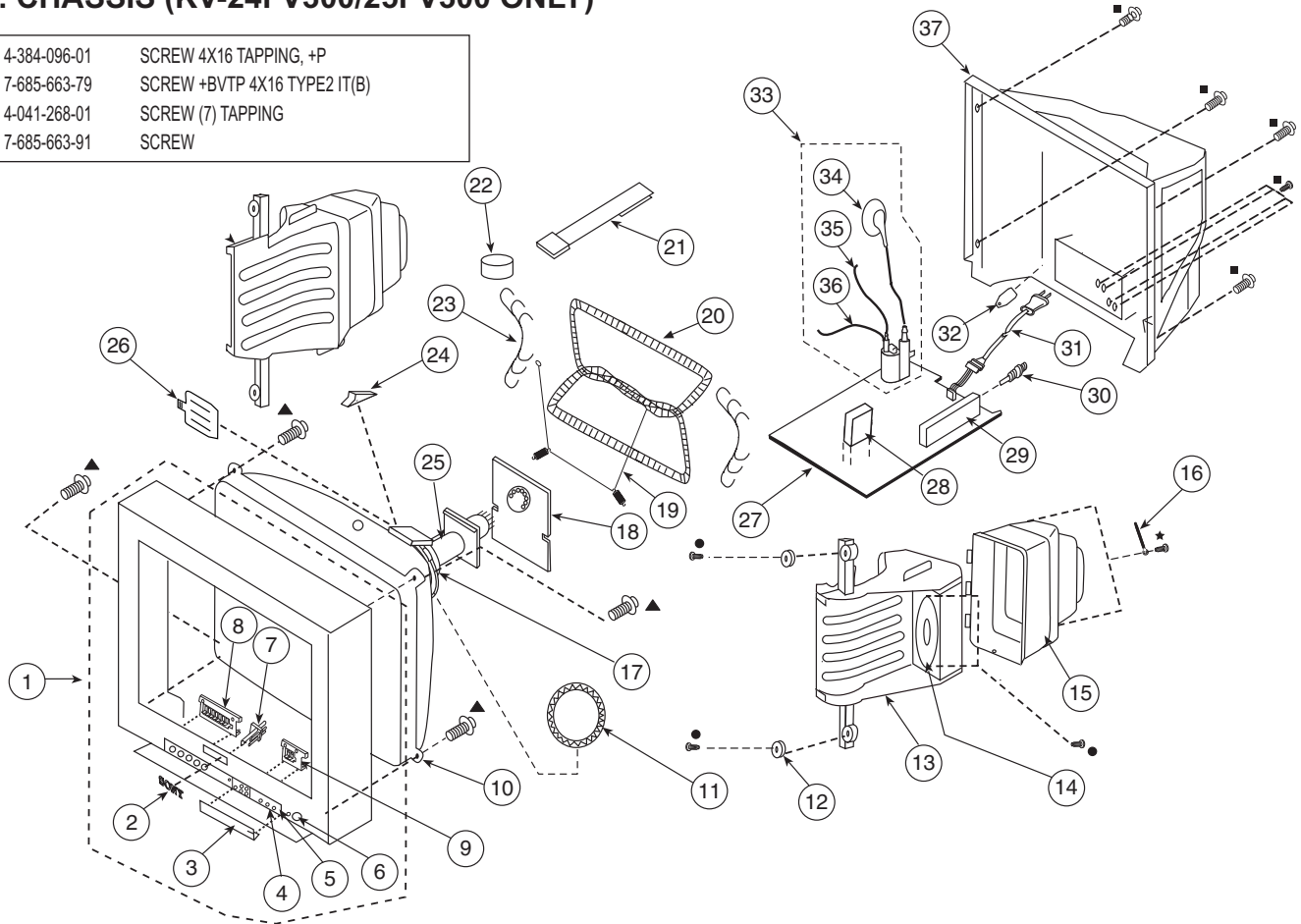

REF. NO.	PART NO.	DESCRIPTION	[Assembly Includes]	REF. NO.	PART NO.	DESCRIPTION	[Assembly Includes]
1	X-4039-943-1	BEZNET ASSY	2-8	25	1-451-552-11	NECK ASSEMBLY	
2	4-046-160-21	EMBLEM, SONY (NO.9)		26	4-057-714-01	PIECE, TLH CONVERGENCE	
3	4-087-155-01	DOOR, CONTROL		* 27	A-1300-306-A	A COMPLETE PC BOARD 25FV300(S) (ONLY)	28
4	4-074-895-71	LABEL, FRONT TERMINAL (20)				The high-voltage leads associated with the FBT on this board are not included and must be ordered separately (SEE 34-36).	
5	4-042-192-01	CATCHER, PUSH		* 27	A-1300-217-A	A COMPLETE PC BOARD 24FV300/25FV300(N) (ONLY)	28
6	4-087-150-01	BUTTON, POWER				The high-voltage leads associated with the FBT on this board are not included and must be ordered separately (SEE 34-36).	
7	4-087-156-01	GUIDE, LIGHT		28	A-1400-739-A	M3 (VAR) MOUNTED PC BOARD	
8	4-087-151-01	BUTTON, MULTI		▲ 29	8-598-593-00	TUNER, FSS BTF-WA421	
* 9	A-1400-251-A	HR (COM) MOUNTED PC BOARD		▲ 30	1-766-374-11	PLUG, F-PIN	
▲ 10	8-733-250-05	CRT 25RSN (A60LPN50X)		▲ 31	1-757-840-12	CORD, POWER (WITH CONNECTOR) 25FV300(S) (ONLY)	
▲ 11	1-452-896-11	COIL, NA ROTATION (RT200)		▲ 31	1-824-069-11	CORD, AC 24FV300/25FV300(N) (ONLY)	
12	4-374-745-31	CUSHION (A)		32	4-081-980-11	HOLDER, AC CABLE	
13	4-087-408-01	BAFFLE, SPEAKER		▲ 33	1-453-336-11	FBT ASSY NX-4011//X4A4	34-36
14	1-529-640-11	SPEAKER (13X8CM)		▲ 34	1-251-642-52	CAP ASSY, HIGH-VOLTAGE	
15	4-087-409-01	COVER, SPEAKER		▲ 35	1-900-800-65	CONNECTOR ASSY, FOCUS LEAD	
16	4-857472-01	CLAMP		▲ 36	1-900-803-22	WIRE ASSY, G2 LEAD	
▲ 17	1-451-475-11	DY (Y25RSA)		37	4-087-406-01	COVER, REAR	
18	A-1400-341-A	CV (VAR) MOUNTED PC					
* 19	4-036-329-01	SPRING (B), TENSION					
▲ 20	1-419-509-21	COIL, DEGAUSSING					
21	4-083-414-01	PIECE A(110), CONV CORRECT					
22	1-452-032-00	MAGNET, DISC					
* 23	4-080-810-21	BAND, DEGAUSS COIL					
24	4-053-005-01	SPACER, DY					

SECTION 7: ELECTRICAL PARTS LIST

PARTS LISTING TABLE OF CONTENTS

Page

A BOARD COMMON PARTS LIST: Parts common to all models listed in this manual52

A BOARD VARIANT PARTS LIST: Parts that belong ONLY to the model specified

Refer to the designated variant parts list when seeking a part indicated by an asterisk (*) on the A Board Schematic or by the word 'variant' on the common parts list.

<u>Model</u>	<u>Page</u>
KV-20FS100/21FS100(N)	60
KV-21FS100(S)	62
KV-20FV300/21FV300(N)	64
KV-21FV300(S)	67
KV-21FM100(N)	70
KV-21FM100(S).....	72
KV-25FV300(S)	74
KV-24FV300/25FV300(N)	77
CV BOARD <u>COMPLETE</u> PARTS LIST (FOR KV-21FS100/21FM100/21FV300/20FV300/20FS100 ONLY).....	80
CV BOARD <u>COMPLETE</u> PARTS LIST (FOR KV-24FV300/25FV300 ONLY)	80
HR BOARD <u>COMPLETE</u> PARTS LIST (FOR KV-21FV300/20FV300/24FV300/25FV300 ONLY).....	82
M3 BOARD <u>COMPLETE</u> PARTS LIST.....	82
ACCESSORIES AND PACKING	83

ELECTRICAL PARTS LIST

NOTE: The components identified by shading and  mark are critical FOR safety. Replace ONLY with part number specified.

NOTE: Les composants identifiés par un trame et une marque  sont critiques pour la sécurité. Ne les remplacer que par une pièce portant le numéro spécifié.

The components in this manual identified by the following symbol:  indicate parts that have been carefully factory-selected to satisfy regulations regarding X-ray radiation FOR each set.

Should replacement be required FOR one of these components, replace ONLY with the value originally used.

* Items marked with an asterisk are not stocked since they are seldom required FOR routine service. Expect some delay when ordering these components.



COMMON PARTS LIST





RESISTORS

- All resistors are in ohms
- F : nonflammable
- All variable and adjustable resistors have characteristic curve B, unless otherwise noted.

When ordering parts by reference number, please include the board name.







REF. NO.	PART NO.	DESCRIPTION	VALUES	REF. NO.	PART NO.	DESCRIPTION	VALUES
<div style="border: 1px solid black; padding: 5px; width: fit-content;">A</div> <p>A-1300-146-A KV-21FS100 (LATIN NORTH) / 20FS100 A-1300-147-A KV-21FM100 (LATIN NORTH) A-1300-156-A KV-21FV300 (LATIN NORTH) / 20FV300 A-1300-217-A KV-25FV300 (LATIN NORTH) / 24FV300 A-1300-242-A KV-21FS100 (LATIN SOUTH) A-1300-243-A KV-21FM100 (LATIN SOUTH) A-1300-271-A KV-21FV300 (LATIN SOUTH) A-1300-306-A KV-25FV300 (LATIN SOUTH)</p> <p>The high voltage leads associated with the FBT on this board are not included and must be ordered separately.</p> <div style="background-color: #f0f0f0; padding: 5px;"> <p> 1-251-642-52 HV CAP ASSY  1-900-800-65 FOCUS LEAD  1-900-803-22 G2 LEAD</p> </div> <p>CAPACITOR</p>				C022	1-126-964-11	ELECT	10µF 20% 50V
				C023	1-126-935-11	ELECT	470µF 20% 16V
				C033	1-162-970-11	CERAMIC CHIP	0.01µF 10% 25V
				C041	1-126-964-11	ELECT	10µF 20% 50V
				C047	1-164-315-11	CERAMIC CHIP	470pF 5% 50V
				C048	1-104-665-11	ELECT	100µF 20% 25V
				C049	1-126-960-11	ELECT	1µF 20% 50V
				C051	1-126-964-11	ELECT	10µF 20% 50V
				C052	1-164-230-11	CERAMIC CHIP	220pF 5% 50V
				C053	1-165-176-11	CERAMIC CHIP	0.047µF 10% 16V
C054	1-126-960-11	ELECT	1µF 20% 50V				
C056	1-162-966-11	CERAMIC CHIP	0.0022µF 10% 50V				
C057	1-107-826-11	CERAMIC CHIP	0.1µF 10% 16V				
C064	1-165-176-11	CERAMIC CHIP	0.047µF 10% 16V				
C066	VARIANT (SEE VARIANT PARTS LIST)						
C069	VARIANT (SEE VARIANT PARTS LIST)						
C074	1-126-964-11	ELECT	10µF 20% 50V				
C075	1-126-935-11	ELECT	470µF 20% 16V				
C076	1-104-665-11	ELECT	100µF 20% 25V				
C077	1-126-947-11	ELECT	47µF 20% 25V				
C079	1-162-968-11	CERAMIC CHIP	0.0047µF 10% 50V				
C080	1-128-934-91	CERAMIC CHIP	0.33µF 20% 10V				
C081	1-128-934-91	CERAMIC CHIP	0.33µF 20% 10V				
C090	1-162-970-11	CERAMIC CHIP	0.01µF 10% 25V				
C091	1-126-947-11	ELECT	47µF 20% 25V				
C092	1-126-947-11	ELECT	47µF 20% 25V				
C094	1-162-970-11	CERAMIC CHIP	0.01µF 10% 25V				
C095	1-126-947-11	ELECT	47µF 20% 25V				
C096	1-162-970-11	CERAMIC CHIP	0.01µF 10% 25V				
C097	1-126-947-11	ELECT	47µF 20% 25V				
C098	1-162-970-11	CERAMIC CHIP	0.01µF 10% 25V				
C099	1-126-947-11	ELECT	47µF 20% 25V				
C100	1-126-956-91	ELECT	0.1µF 20% 50V				
C115	1-164-739-11	CERAMIC CHIP	560pF 5% 50V				
C116	1-107-826-11	CERAMIC CHIP	0.1µF 10% 16V				
C001	VARIANT (SEE VARIANT PARTS LIST)						
C003	1-162-919-11	CERAMIC CHIP	22pF 5% 50V				
C004	1-162-923-11	CERAMIC CHIP	47pF 5% 50V				
C005	1-162-966-11	CERAMIC CHIP	0.0022µF 10% 50V				
C006	1-126-942-61	ELECT	1000µF 20% 25V				
C007	1-164-315-11	CERAMIC CHIP	470pF 5% 50V				
C008	1-126-956-91	ELECT	0.1µF 20% 50V				
C009	1-164-230-11	CERAMIC CHIP	220pF 5% 50V				
C010	1-126-960-11	ELECT	1µF 20% 50V				
C011	1-162-964-11	CERAMIC CHIP	0.001µF 10% 50V				
C012	1-162-968-11	CERAMIC CHIP	0.0047µF 10% 50V				
C014	1-126-960-11	ELECT	1µF 20% 50V				
C015	1-107-826-11	CERAMIC CHIP	0.1µF 10% 16V				
C019	1-126-956-91	ELECT	0.1µF 20% 50V				
C021	1-107-826-11	CERAMIC CHIP	0.1µF 10% 16V				

NOTE: The components identified by shading and  mark are critical FOR safety. Replace ONLY with part number specified.

NOTE: Les composants identifiés par un triangle et une marque  sont critiques pour la sécurité. Ne les remplacer que par une pièce portant le numéro spécifique.

COMMON PARTS LIST



REF. NO.	PART NO.	DESCRIPTION	VALUES	REF. NO.	PART NO.	DESCRIPTION	VALUES
C200	VARIANT (SEE VARIANT PARTS LIST)			C513	1-106-383-00	MYLAR	0.047μF 10% 200V
C202-C207	VARIANT (SEE VARIANT PARTS LIST)			C514	VARIANT (SEE VARIANT PARTS LIST)		
C212-C213	VARIANT (SEE VARIANT PARTS LIST)			C515	1-107-651-11	ELECT	4.7μF 20% 250V
C220	VARIANT (SEE VARIANT PARTS LIST)			C516	VARIANT (SEE VARIANT PARTS LIST)		
C301-C302	VARIANT (SEE VARIANT PARTS LIST)			C520	1-126-965-91	ELECT	22μF 20% 50V
C303	1-126-956-91	ELECT	0.1μF 20% 50V	C521	1-126-960-11	ELECT	1μF 20% 50V
C304	1-126-956-91	ELECT	0.1μF 20% 50V	C522	1-162-923-11	CERAMIC CHIP	47pF 5% 50V
C305-C307	VARIANT (SEE VARIANT PARTS LIST)			C523	VARIANT (SEE VARIANT PARTS LIST)		
C312	1-164-230-11	CERAMIC CHIP	220pF 5% 50V	C525	1-164-646-11	CERAMIC	2200pF 10% 500V
C313	1-126-956-91	ELECT	0.1μF 20% 50V	C526	1-102-244-00	CERAMIC	220pF 10% 500V
C325	1-162-967-11	CERAMIC CHIP	0.0033μF 10% 50V	C527	1-107-645-11	ELECT	22μF 20% 160V
C326	1-127-715-91	CERAMIC CHIP	0.22μF 10% 16V	C529	1-162-966-11	CERAMIC CHIP	0.0022μF 10% 50V
C328	1-162-970-11	CERAMIC CHIP	0.01μF 10% 25V	C534	1-162-966-11	CERAMIC CHIP	0.0022μF 10% 50V
C330	1-162-970-11	CERAMIC CHIP	0.01μF 10% 25V	C535-C536	VARIANT (SEE VARIANT PARTS LIST)		
C337	1-162-919-11	CERAMIC CHIP	22pF 5% 50V	C537	1-162-964-11	CERAMIC CHIP	0.001μF 10% 50V
C351	1-164-315-11	CERAMIC CHIP	470pF 5% 50V	C539	1-162-970-11	CERAMIC CHIP	0.01μF 10% 25V
C360-C363	VARIANT (SEE VARIANT PARTS LIST)			C542	1-162-966-11	CERAMIC CHIP	0.0022μF 10% 50V
C370	VARIANT (SEE VARIANT PARTS LIST)			C544	1-126-967-11	ELECT	47μF 20% 50V
C390	1-162-970-11	CERAMIC CHIP	0.01μF 10% 25V	C545	1-126-969-11	ELECT	220μF 20% 50V
C400-C416	VARIANT (SEE VARIANT PARTS LIST)			C546	1-137-194-81	FILM	0.47μF 5% 50V
C418	VARIANT (SEE VARIANT PARTS LIST)			C551	1-126-960-11	ELECT	1μF 20% 50V
C420	VARIANT (SEE VARIANT PARTS LIST)			C552	1-126-964-11	ELECT	10μF 20% 50V
C422	VARIANT (SEE VARIANT PARTS LIST)			C553	1-107-826-11	CERAMIC CHIP	0.1μF 10% 16V
C424	VARIANT (SEE VARIANT PARTS LIST)			C554	1-162-970-11	CERAMIC CHIP	0.01μF 10% 25V
C440	1-126-940-11	ELECT	330μF 20% 25V	 C561	1-126-963-11	ELECT	4.7μF 20% 50V
C441	1-126-940-11	ELECT	330μF 20% 25V	 C562	1-104-666-11	ELECT	220μF 20% 25V
C450	1-126-943-11	ELECT	2200μF 20% 25V	C563	1-162-970-11	CERAMIC CHIP	0.01μF 10% 25V
C451	1-126-959-11	ELECT	0.47μF 20% 50V	 C566	1-107-635-11	ELECT	4.7μF 20% 160V
C452	VARIANT (SEE VARIANT PARTS LIST)			C571	1-104-665-11	ELECT	100μF 20% 25V
C453	1-126-933-11	ELECT	100μF 20% 16V	C582	1-106-387-00	MYLAR	0.068μF 10% 200V
C454-C455	VARIANT (SEE VARIANT PARTS LIST)			 C588	1-137-417-11	MYLAR	0.0047μF 10% 200V
C457-C464	VARIANT (SEE VARIANT PARTS LIST)			C589	1-128-560-11	ELECT	22μF 20% 100V
C470	1-126-940-11	ELECT	330μF 20% 25V	 C590	1-126-964-11	ELECT	10μF 20% 50V
C498	1-126-960-11	ELECT	1μF 20% 50V	C594	1-123-024-21	ELECT	33μF 160V
C499-C500	VARIANT (SEE VARIANT PARTS LIST)			C595	1-104-666-11	ELECT	220μF 20% 25V
C502	1-102-112-00	CERAMIC	330pF 10% 50V	C597	1-104-666-11	ELECT	220μF 20% 25V
C503	1-106-383-00	MYLAR	0.047μF 10% 200V	C600	1-126-964-11	ELECT	10μF 20% 50V
C504	1-102-212-00	CERAMIC	820pF 10% 500V	C602-C603	VARIANT (SEE VARIANT PARTS LIST)		
C505	1-102-002-00	CERAMIC	680pF 10% 500V	 C605	1-127-793-51	CERAMIC	2200pF 20% 250V
C506-C508	VARIANT (SEE VARIANT PARTS LIST)			 C606	1-127-793-51	CERAMIC	2200pF 20% 250V
C509	1-128-551-11	ELECT	22μF 20% 25V	C609	1-126-942-61	ELECT	1000μF 20% 25V
C510	1-117-214-11	CERAMIC	0.001μF 10% 2KV	C610	1-164-644-11	CERAMIC	330pF 10% 500V
C511	VARIANT (SEE VARIANT PARTS LIST)			C611	1-126-971-11	ELECT	470μF 20% 50V
C512	1-104-987-11	MYLAR	0.001μF 10% 100V	C612	1-126-961-11	ELECT	2.2μF 20% 50V

COMMON PARTS LIST











REF. NO.	PART NO.	DESCRIPTION	VALUES	REF. NO.	PART NO.	DESCRIPTION	VALUES
C613	1-161-964-91	CERAMIC	0.0047μF 250V	CN585	1-564-509-11	PLUG,CONNECTOR	6P
C614	1-161-964-91	CERAMIC	0.0047μF 250V	CN600	1-580-843-11	PIN,CONNECTOR (POWER)	
C615	1-161-964-91	CERAMIC	0.0047μF 250V			DIODE	
C616	1-126-943-11	ELECT	2200μF 20% 25V	D001		VARIANT (SEE VARIANT PARTS LIST)	
C617	1-128-564-11	ELECT	220μF 20% 100V	D002	8-719-109-89	DIODE MTZJ-T-77-5.6B	
C618	1-128-564-11	ELECT	220μF 20% 100V	D003	8-719-110-17	DIODE MTZJ-T-77-10B	
C619	1-161-964-91	CERAMIC	0.0047μF 250V	D004	8-719-110-17	DIODE MTZJ-T-77-10B	
C620	1-162-970-11	CERAMIC CHIP	0.01μF 10% 25V	D005	8-719-110-17	DIODE MTZJ-T-77-10B	
C621		VARIANT (SEE VARIANT PARTS LIST)		D006	8-719-921-44	DIODE MTZJ-T-77-5.1C	
C624	1-107-636-11	ELECT	10μF 20% 160V	D044	8-719-110-17	DIODE MTZJ-T-77-10B	
C625	1-126-964-11	ELECT	10μF 20% 50V	D045	8-719-110-17	DIODE MTZJ-T-77-10B	
C629		VARIANT (SEE VARIANT PARTS LIST)		D050	8-719-991-33	DIODE 1SS133T-77	
C632	1-126-967-11	ELECT	47μF 20% 50V	D051	8-719-991-33	DIODE 1SS133T-77	
C633	1-136-479-11	FILM	0.001μF 2% 50V	D052	8-719-109-89	DIODE MTZJ-T-77-5.6B	
C634	1-126-947-11	ELECT	47μF 20% 25V	D200		VARIANT (SEE VARIANT PARTS LIST)	
C635	1-126-963-11	ELECT	4.7μF 20% 50V	D201	8-719-929-15	DIODE MTZJ-T-77-9.1B	
C636	1-127-715-91	CERAMIC CHIP	0.22μF 10% 16V	D202	8-719-929-15	DIODE MTZJ-T-77-9.1B	
C637	1-127-715-91	CERAMIC CHIP	0.22μF 10% 16V	D203-D206		VARIANT (SEE VARIANT PARTS LIST)	
C638	1-104-665-11	ELECT	100μF 20% 25V	D208		VARIANT (SEE VARIANT PARTS LIST)	
C640	1-164-644-11	CERAMIC	330pF 10% 500V	D230	8-719-108-12	DIODE RD9.1EW-T1	
C642	1-126-969-11	ELECT	220μF 20% 50V	D231		VARIANT (SEE VARIANT PARTS LIST)	
C643	1-130-777-00	MYLAR	0.1μF 5% 100V	D232	8-719-108-12	DIODE RD9.1EW-T1	
C645	1-162-964-11	CERAMIC CHIP	0.001μF 10% 50V	D234-D237		VARIANT (SEE VARIANT PARTS LIST)	
C647	1-126-947-11	ELECT	47μF 20% 25V	D351	8-719-109-66	DIODE MTZJ-T-77-3.3B	
C648	1-162-115-00	CERAMIC	330pF 10% 1KV	D390	8-719-404-50	DIODE MA111-TX	
C649	1-162-115-00	CERAMIC	330pF 10% 1KV	D410	8-719-404-50	DIODE MA111-TX	
C650	1-126-942-61	ELECT	1000μF 20% 25V	D412	1-216-864-11	SHORT	
C651	1-126-942-61	ELECT	1000μF 20% 25V	D413	8-719-404-50	DIODE MA111-TX	
C652	1-164-227-11	CERAMIC CHIP	0.022μF 10% 25V	D414	8-719-921-63	DIODE MTZJ-T-77-7.5B	
C660	1-126-947-11	ELECT	47μF 20% 25V	D435	8-719-110-17	DIODE MTZJ-T-77-10B	
C661	1-104-665-11	ELECT	100μF 20% 25V	D438	8-719-404-50	DIODE MA111-TX	
C663	1-126-963-11	ELECT	4.7μF 20% 50V	D501	8-719-404-50	DIODE MA111-TX	
C665	1-104-665-11	ELECT	100μF 20% 25V	D505	8-719-081-00	DIODE BY228/A52A/	
C672		VARIANT (SEE VARIANT PARTS LIST)		D506		VARIANT (SEE VARIANT PARTS LIST)	
C680	1-127-793-51	CERAMIC	2200pF 20% 250V	D508	8-719-404-50	DIODE MA111-TX	
C681	1-127-793-51	CERAMIC	2200pF 20% 250V	D509	8-719-109-66	DIODE MTZJ-T-77-3.3B	
C690	1-162-970-11	CERAMIC CHIP	0.01μF 10% 25V	D514	8-719-908-03	DIODE GP08DPKG23	
		CONNECTOR		D515	8-719-908-03	DIODE GP08DPKG23	
CN001	1-560-124-00	PLUG,CONNECTOR (2.5MM)	4P	D525	8-719-991-33	DIODE 1SS133T-77	
CN002		VARIANT (SEE VARIANT PARTS LIST)		D526	8-719-302-43	DIODE RGP10GPKG23	
CN401	1-564-507-11	PLUG,CONNECTOR	4P	D528	8-719-991-33	DIODE 1SS133T-77	
CN501	1-508-786-00	PIN,CONNECTOR (5MM PITCH)	2P	D545	8-719-908-03	DIODE GP08DPKG23	
CN515	1-580-798-11	CONNECTOR PIN (DY)	6P	D558	8-719-404-50	DIODE MA111-TX	

COMMON PARTS LIST



NOTE: The components identified by shading and  mark are critical FOR safety. Replace ONLY with part number specified.

NOTE: Les composants identifiés par un trame et une  sont critiques pour la sécurité. Ne les remplacer que par une pièce portant le numéro spécifique.

REF. NO.	PART NO.	DESCRIPTION	VALUES	REF. NO.	PART NO.	DESCRIPTION	VALUES
D559	8-719-404-50	DIODE MA111-TX		IC			
 D562	8-719-991-33	DIODE 1SS133T-77		 IC001	6-800-842-01	IC M65582UF-100FP	
 D566	8-719-979-84	DIODE EGP20DPKG23		IC002	8-759-699-33	IC M24C16-MN6T(A)	
 D567	8-719-991-33	DIODE 1SS133T-77		IC003	8-759-352-91	IC PST9143NL	
D568	8-719-110-08	DIODE MTZJ-T-77-8.2B		IC004-IC005 VARIANT (SEE VARIANT PARTS LIST)			
 D569	8-719-921-44	DIODE MTZJ-T-77-5.1C		IC400-IC402 VARIANT (SEE VARIANT PARTS LIST)			
D587	8-719-302-43	DIODE RGP10GPKG23		IC404	VARIANT (SEE VARIANT PARTS LIST)		
 D589	8-719-991-33	DIODE 1SS133T-77		IC545	VARIANT (SEE VARIANT PARTS LIST)		
D596	VARIANT (SEE VARIANT PARTS LIST)			 IC561	8-759-700-07	IC NJM2903M-TE2	
D598	VARIANT (SEE VARIANT PARTS LIST)			IC565	8-759-700-44	IC NJM2902M-TE2	
D605	8-719-510-53	DIODE D4SB60L-F		IC600	8-759-670-30	IC MCZ3001D	
D608	8-719-077-76	DIODE D2SB60A-F04		IC603	8-759-833-71	IC NJM2395F09	
D611	8-719-302-43	DIODE EL1Z-V1		 IC604	8-749-012-13	IC DM-58	
D612-D613	VARIANT (SEE VARIANT PARTS LIST)			IC608	8-759-450-47	IC BA05T	
D614	8-719-057-52	DIODE EZ0150AV1		IC633	8-759-445-59	IC BA033T	
D615	6-500-177-01	DIODE MA7D50		JACK			
D618	8-719-979-64	DIODE μ F4005PKG23		J200-J202	VARIANT (SEE VARIANT PARTS LIST)		
D620	8-719-911-19	DIODE 1SS119-25TD		J205-J206	VARIANT (SEE VARIANT PARTS LIST)		
D621	8-719-510-37	DIODE D5LC20U		J401	1-568-267-21	JACK	
D624	8-719-302-43	DIODE EL1Z-V1		CHIP CONDUCTOR			
D628	8-719-404-50	DIODE MA111-TX		JR102	1-216-864-11	SHORT	
D629	8-719-110-31	DIODE MTZJ-T-77-12B		JR128	1-216-864-11	SHORT	
D630	8-719-982-22	DIODE MTZJ-T-77-30D		JR200	1-216-864-11	SHORT	
D631	8-719-063-70	DIODE D1NL20U-TA2		JR301	1-216-864-11	SHORT	
D650	8-719-109-89	DIODE MTZJ-T-77-5.6C		JR302	1-216-864-11	SHORT	
FUSE				JR303	1-216-864-11	SHORT	
F601	VARIANT (SEE VARIANT PARTS LIST)			JR304	1-216-864-11	SHORT	
FERRITE BEAD				JR305	1-216-864-11	SHORT	
FB505	1-410-397-21	FERRITE	1.1 μ H	JR306	1-216-864-11	SHORT	
FB522	1-410-397-21	FERRITE	1.1 μ H	JR307	1-216-864-11	SHORT	
FB601	1-412-911-11	FERRITE	0 μ H	JR308	1-216-864-11	SHORT	
FB602	1-412-911-11	FERRITE	0 μ H	JR309	1-216-864-11	SHORT	
FB603	1-412-911-11	FERRITE	0 μ H	JR401	1-216-864-11	SHORT	
FB604	1-412-911-11	FERRITE	0 μ H	COIL			
FB616	1-469-578-11	FERRITE	1.1 μ H	L002	1-239-803-11	ENCAPSULATED COMPONENT	
FB617	1-469-578-11	FERRITE	1.1 μ H	L003	1-239-803-11	ENCAPSULATED COMPONENT	
FILTER				L004	1-239-803-11	ENCAPSULATED COMPONENT	
FL001	1-239-803-11	ENCAPSULATED COMPONENT		L005	1-239-803-11	ENCAPSULATED COMPONENT	
				L006	1-412-032-11	INDUCTOR	100 μ H

NOTE: The components identified by shading and \triangle mark are critical FOR safety. Replace ONLY with part number specified.

NOTE: Les composants identifiés par un trame et une marque \triangle sont critiques pour la sécurité. Ne les remplacer que par une pièce portant le numéro spécifique.

COMMON PARTS LIST





REF. NO.	PART NO.	DESCRIPTION	VALUES	REF. NO.	PART NO.	DESCRIPTION	VALUES
L007	1-412-032-11	INDUCTOR	100 μ H	Q502	8-729-140-50	TRANSISTOR 2SC3209LK-TP	
L008	1-410-482-31	INDUCTOR	100 μ H	Q505-Q506	VARIANT (SEE VARIANT PARTS LIST)		
L009	1-410-470-11	INDUCTOR	10 μ H	Q521	8-729-423-33	TRANSISTOR 2SC3311A-QRSTA	
L010	1-412-029-11	INDUCTOR	10 μ H	Q522	8-729-053-87	TRANSISTOR KTC4370A	
L360-L361	VARIANT (SEE VARIANT PARTS LIST)			Q572	8-729-422-27	TRANSISTOR 2SD601A-QRS-TX	
L510	VARIANT (SEE VARIANT PARTS LIST)			Q573	8-729-424-02	TRANSISTOR 2SB709A-QRS-TX	
L513	1-406-677-11	INDUCTOR	10MH	Q578	8-729-422-27	TRANSISTOR 2SD601A-QRS-TX	
L515	1-412-552-11	INDUCTOR	2.2MH	\triangle Q590	8-729-200-17	TRANSISTOR 2SA10910-TPE2	
L516	VARIANT (SEE VARIANT PARTS LIST)			Q600-Q601	VARIANT (SEE VARIANT PARTS LIST)		
L525	1-409-955-11	INDUCTOR	8MH	Q604	8-729-424-02	TRANSISTOR 2SB709A-QRS-TX	
\triangle L588	1-412-528-81	INDUCTOR	18 μ H	Q608	8-729-922-37	TRANSISTOR 2SD2144S-TP-UVW	
L606	1-412-525-31	INDUCTOR	10 μ H	Q650	8-729-926-14	TRANSISTOR 2SD1292	
L607	1-412-525-31	INDUCTOR	10 μ H	RESISTOR			
L608	1-412-533-21	INDUCTOR	47 μ H	R001	VARIANT (SEE VARIANT PARTS LIST)		
L609	1-412-525-31	INDUCTOR	10 μ H	R002	1-216-864-11	SHORT	
PHOTO COUPLER				R003	1-216-821-11	RES-CHIP	1K 5% 1/10W
PH602	8-749-010-64	PHOTO COUPLER	PC123FY2	R004	1-216-817-11	RES-CHIP	470 5% 1/10W
IC LINK				R006	1-216-829-11	RES-CHIP	4.7K 5% 1/10W
PS401	VARIANT (SEE VARIANT PARTS LIST)			R015	1-216-833-11	RES-CHIP	10K 5% 1/10W
TRANSISTOR				R027	1-218-732-11	METAL CHIP	47K 0.50% 1/16W
Q002	8-729-422-27	TRANSISTOR 2SD601A-QRS-TX		R028	1-249-409-11	CARBON	220 5% 1/4W
Q004	8-729-422-27	TRANSISTOR 2SD601A-QRS-TX		R029-R030	VARIANT (SEE VARIANT PARTS LIST)		
Q005	8-729-424-02	TRANSISTOR 2SB709A-QRS-TX		R031	1-216-813-11	RES-CHIP	220 5% 1/10W
Q006	8-729-422-27	TRANSISTOR 2SD601A-QRS-TX		R032	VARIANT (SEE VARIANT PARTS LIST)		
Q008	8-729-422-27	TRANSISTOR 2SD601A-QRS-TX		R033	1-249-409-11	CARBON	220 5% 1/4W
Q009	8-729-422-27	TRANSISTOR 2SD601A-QRS-TX		R035	1-216-809-11	RES-CHIP	100 5% 1/10W
Q300	8-729-422-27	TRANSISTOR 2SD601A-QRS-TX		R036	VARIANT (SEE VARIANT PARTS LIST)		
Q301	8-729-424-02	TRANSISTOR 2SB709A-QRS-TX		R037	1-216-833-11	RES-CHIP	10K 5% 1/10W
Q303	8-729-424-02	TRANSISTOR 2SB709A-QRS-TX		R038	1-216-821-11	RES-CHIP	1K 5% 1/10W
Q304	8-729-424-02	TRANSISTOR 2SB709A-QRS-TX		R039	1-216-817-11	RES-CHIP	470 5% 1/10W
Q305	8-729-424-02	TRANSISTOR 2SB709A-QRS-TX		R040	1-216-829-11	RES-CHIP	4.7K 5% 1/10W
Q306	8-729-424-02	TRANSISTOR 2SB709A-QRS-TX		R041	1-216-829-11	RES-CHIP	4.7K 5% 1/10W
Q390	8-729-422-27	TRANSISTOR 2SD601A-QRS-TX		R042	1-216-813-11	RES-CHIP	220 5% 1/10W
Q391	8-729-422-27	TRANSISTOR 2SD601A-QRS-TX		R043	1-216-813-11	RES-CHIP	220 5% 1/10W
Q400	8-729-422-27	TRANSISTOR 2SD601A-QRS-TX		R044	1-216-829-11	RES-CHIP	4.7K 5% 1/10W
Q401	8-729-422-27	TRANSISTOR 2SD601A-QRS-TX		R045	1-216-829-11	RES-CHIP	4.7K 5% 1/10W
Q404-Q405	VARIANT (SEE VARIANT PARTS LIST)			R046	VARIANT (SEE VARIANT PARTS LIST)		
Q411	8-729-422-27	TRANSISTOR 2SD601A-QRS-TX		R047	1-249-409-11	CARBON	220 5% 1/4W
Q412	8-729-422-27	TRANSISTOR 2SD601A-QRS-TX		R048	1-216-829-11	RES-CHIP	4.7K 5% 1/10W
Q435	8-729-424-02	TRANSISTOR 2SB709A-QRS-TX		R049	1-216-829-11	RES-CHIP	4.7K 5% 1/10W
Q501	8-729-423-33	TRANSISTOR 2SC3311A-QRSTA		R050	1-249-425-11	CARBON	4.7K 5% 1/4W
				R051	1-249-417-11	CARBON	1K 5% 1/4W
				R052	1-216-813-11	RES-CHIP	220 5% 1/10W

COMMON PARTS LIST











REF. NO.	PART NO.	DESCRIPTION	VALUES			REF. NO.	PART NO.	DESCRIPTION	VALUES		
R053	1-249-433-11	CARBON	22K	5%	1/4W	R109	VARIANT (SEE VARIANT PARTS LIST)				
R054	1-249-433-11	CARBON	22K	5%	1/4W	R110	1-249-409-11	CARBON	220	5%	1/4W
R055	1-216-829-11	RES-CHIP	4.7K	5%	1/10W	R111	VARIANT (SEE VARIANT PARTS LIST)				
R056	1-216-833-11	RES-CHIP	10K	5%	1/10W	R112	1-249-425-11	CARBON	4.7K	5%	1/4W
R057	1-249-417-11	CARBON	1K	5%	1/4W	R115	1-216-817-11	RES-CHIP	470	5%	1/10W
R058	1-249-429-11	CARBON	10K	5%	1/4W	R116	1-216-853-11	RES-CHIP	470K	5%	1/10W
R059	1-249-417-11	CARBON	1K	5%	1/4W	R200	VARIANT (SEE VARIANT PARTS LIST)				
R060	VARIANT (SEE VARIANT PARTS LIST)					R202	VARIANT (SEE VARIANT PARTS LIST)				
R061	1-249-429-11	CARBON	10K	5%	1/4W	R203-R213	VARIANT (SEE VARIANT PARTS LIST)				
R062	1-249-413-11	CARBON	470	5%	1/4W	R215-R218	VARIANT (SEE VARIANT PARTS LIST)				
R063	1-216-829-11	RES-CHIP	4.7K	5%	1/10W	R220-R222	VARIANT (SEE VARIANT PARTS LIST)				
R065	1-249-415-11	CARBON	680	5%	1/4W	R226	1-218-285-11	RES-CHIP	75	5%	1/10W
R067	1-249-416-11	CARBON	820	5%	1/4W	R227	VARIANT (SEE VARIANT PARTS LIST)				
R069	1-249-421-11	CARBON	2.2K	5%	1/4W	R234	VARIANT (SEE VARIANT PARTS LIST)				
R070	1-249-409-11	CARBON	220	5%	1/4W	R250-R251	VARIANT (SEE VARIANT PARTS LIST)				
R071	1-249-427-11	CARBON	6.8K	5%	1/4W	R301	VARIANT (SEE VARIANT PARTS LIST)				
R072	1-249-425-11	CARBON	4.7K	5%	1/4W	R303	1-218-285-11	RES-CHIP	75	5%	1/10W
R073	1-249-419-11	CARBON	1.5K	5%	1/4W	R305-R307	VARIANT (SEE VARIANT PARTS LIST)				
R074	1-249-421-11	CARBON	2.2K	5%	1/4W	R308	1-216-821-11	RES-CHIP	1K	5%	1/10W
R075	1-249-427-11	CARBON	6.8K	5%	1/4W	R309	1-216-833-11	RES-CHIP	10K	5%	1/10W
R076	1-247-807-31	CARBON	100	5%	1/4W	R310	1-216-821-11	RES-CHIP	1K	5%	1/10W
R079	VARIANT (SEE VARIANT PARTS LIST)					R311	1-216-813-11	RES-CHIP	220	5%	1/10W
R080	1-216-833-11	RES-CHIP	10K	5%	1/10W	R312	1-218-867-11	RES-CHIP	6.8K	5%	1/10W
R081	1-216-841-11	RES-CHIP	47K	5%	1/10W	R313	1-216-864-11	SHORT			
R082	1-216-857-11	RES-CHIP	1M	5%	1/10W	R314	1-216-833-11	RES-CHIP	10K	5%	1/10W
R083	1-216-847-11	RES-CHIP	150K	5%	1/10W	R315	1-216-813-11	RES-CHIP	220	5%	1/10W
R084	1-216-819-11	RES-CHIP	680	5%	1/10W	R316	1-216-825-11	RES-CHIP	2.2K	5%	1/10W
R085	VARIANT (SEE VARIANT PARTS LIST)					R317	1-216-813-11	RES-CHIP	220	5%	1/10W
R086	1-216-821-11	RES-CHIP	1K	5%	1/10W	R318	1-216-825-11	RES-CHIP	2.2K	5%	1/10W
R087	1-247-807-31	CARBON	100	5%	1/4W	R319	1-216-813-11	RES-CHIP	220	5%	1/10W
R090	1-216-837-11	RES-CHIP	22K	5%	1/10W	R320	1-216-825-11	RES-CHIP	2.2K	5%	1/10W
R091	1-216-841-11	RES-CHIP	47K	5%	1/10W	R321	1-247-807-31	CARBON	100	5%	1/4W
R092	1-216-825-11	RES-CHIP	2.2K	5%	1/10W	R322	1-216-817-11	RES-CHIP	470	5%	1/10W
R093	1-216-841-11	RES-CHIP	47K	5%	1/10W	R323	1-249-414-11	CARBON	560	5%	1/4W
R094	1-216-864-11	SHORT				R324	1-216-826-11	RES-CHIP	2.7K	5%	1/10W
R095	1-216-864-11	SHORT				R337	1-216-801-11	RES-CHIP	22	5%	1/10W
R096	1-216-829-11	RES-CHIP	4.7K	5%	1/10W	R351	1-216-833-11	RES-CHIP	10K	5%	1/10W
R098	1-216-839-11	RES-CHIP	33K	5%	1/10W	R352	1-216-853-11	RES-CHIP	470K	5%	1/10W
R101	VARIANT (SEE VARIANT PARTS LIST)					R360-R361	VARIANT (SEE VARIANT PARTS LIST)				
R102	1-216-837-11	RES-CHIP	22K	5%	1/10W	R370	1-216-825-11	RES-CHIP	2.2K	5%	1/10W
R103	1-216-833-11	RES-CHIP	10K	5%	1/10W	R371	1-216-857-11	RES-CHIP	1M	5%	1/10W
R104-R106	VARIANT (SEE VARIANT PARTS LIST)					R372	1-216-827-11	RES-CHIP	3.3K	5%	1/10W
R107	1-216-809-11	RES-CHIP	100	5%	1/10W	R390	1-216-864-11	SHORT			
R108	1-216-809-11	RES-CHIP	100	5%	1/10W	R391	1-216-829-11	RES-CHIP	4.7K	5%	1/10W

NOTE: The components identified by shading and  mark are critical FOR safety. Replace ONLY with part number specified.

A component identified by this  symbol indicates that it has been carefully factory-selected to satisfy regulations regarding X-ray radiation. Should replacement be required, replace ONLY with the value originally used.

COMMON PARTS LIST









REF. NO.	PART NO.	DESCRIPTION	VALUES			REF. NO.	PART NO.	DESCRIPTION	VALUES		
R392	1-216-818-11	RES-CHIP	560	5%	1/10W	R521	1-216-819-11	RES-CHIP	680	5%	1/10W
R393	1-216-825-11	RES-CHIP	2.2K	5%	1/10W	R522	1-249-411-11	CARBON	330	5%	1/4W
R394	1-216-833-11	RES-CHIP	10K	5%	1/10W	R524	1-218-867-11	RES-CHIP	6.8K	5%	1/10W
R400-R401	VARIANT (SEE VARIANT PARTS LIST)					R525	1-215-861-00	METAL OXIDE	47	5%	1W
R402	1-216-864-11	SHORT				R526	1-216-837-11	RES-CHIP	22K	5%	1/10W
R403-R405	VARIANT (SEE VARIANT PARTS LIST)					R527	1-216-825-11	RES-CHIP	2.2K	5%	1/10W
R406	1-216-813-11	RES-CHIP	220	5%	1/10W	R528	VARIANT (SEE VARIANT PARTS LIST)				
R407	1-216-813-11	RES-CHIP	220	5%	1/10W	R529	VARIANT (SEE VARIANT PARTS LIST)				
R410	VARIANT (SEE VARIANT PARTS LIST)					R530	1-216-829-11	RES-CHIP	4.7K	5%	1/10W
R413	VARIANT (SEE VARIANT PARTS LIST)					R533	VARIANT (SEE VARIANT PARTS LIST)				
R415	1-216-864-11	SHORT				R534	1-216-835-11	RES-CHIP	15K	5%	1/10W
R416	1-216-864-11	SHORT				R535-R538	VARIANT (SEE VARIANT PARTS LIST)				
R427	VARIANT (SEE VARIANT PARTS LIST)					R539	1-216-864-11	SHORT			
R429	VARIANT (SEE VARIANT PARTS LIST)					R540	1-249-429-11	CARBON	10K	5%	1/4W
R431-R434	VARIANT (SEE VARIANT PARTS LIST)					R541	VARIANT (SEE VARIANT PARTS LIST)				
R435	1-216-833-11	RES-CHIP	10K	5%	1/10W	R542	1-215-445-00	METAL	10K	1%	1/4W
R436	1-216-864-11	SHORT				R543	1-216-351-00	METAL OXIDE	1.5	5%	1W
R437	1-216-829-11	RES-CHIP	4.7K	5%	1/10W	R545	1-215-890-11	METAL OXIDE	470	5%	2W
R438	1-249-417-11	CARBON	1K	5%	1/4W	R546	1-249-385-11	CARBON	2.2	5%	1/4W
R440	1-249-409-11	CARBON	220	5%	1/4W	R547	1-215-445-00	METAL	10K	1%	1/4W
R441	1-249-409-11	CARBON	220	5%	1/4W	R548-R549	VARIANT (SEE VARIANT PARTS LIST)				
R455-R462	VARIANT (SEE VARIANT PARTS LIST)					R550	1-216-817-11	RES-CHIP	470	5%	1/10W
R463	1-249-437-11	CARBON	47K	5%	1/4W	R552	VARIANT (SEE VARIANT PARTS LIST)				
R464	1-216-841-11	RES-CHIP	47K	5%	1/10W	R553	1-216-821-11	RES-CHIP	1K	5%	1/10W
R477	1-216-821-11	RES-CHIP	1K	5%	1/10W	R555	1-216-833-11	RES-CHIP	10K	5%	1/10W
R478	1-216-833-11	RES-CHIP	10K	5%	1/10W	R557	1-216-825-11	RES-CHIP	2.2K	5%	1/10W
R479	1-216-821-11	RES-CHIP	1K	5%	1/10W	R560	1-216-821-11	RES-CHIP	1K	5%	1/10W
R482	VARIANT (SEE VARIANT PARTS LIST)					 R561	1-216-833-11	RES-CHIP	10K	5%	1/10W
R484	1-216-809-11	RES-CHIP	100	5%	1/10W	 R562	1-249-429-11	CARBON	10K	5%	1/4W
R485	1-216-809-11	RES-CHIP	100	5%	1/10W	 R563	1-216-833-11	RES-CHIP	10K	5%	1/10W
R487-R490	VARIANT (SEE VARIANT PARTS LIST)					R564	VARIANT (SEE VARIANT PARTS LIST)				
R494	1-216-833-11	RES-CHIP	10K	5%	1/10W	  R565	1-216-833-11	RES-CHIP	10K	5%	1/10W
R498	1-216-864-11	SHORT				 R566	1-215-469-00	METAL	100K	1%	1/4W
R499	VARIANT (SEE VARIANT PARTS LIST)					 R567	1-215-879-11	METAL OXIDE	47K	5%	1W
R502	1-249-425-11	CARBON	4.7K	5%	1/4W	 R568	1-215-416-00	METAL	620	1%	1/4W
R503	VARIANT (SEE VARIANT PARTS LIST)					R569	1-249-429-11	CARBON	10K	5%	1/4W
R504	1-249-426-11	CARBON	5.6K	5%	1/4W	R570	1-249-429-11	CARBON	10K	5%	1/4W
R507	1-216-833-11	RES-CHIP	10K	5%	1/10W	R572	1-216-829-11	RES-CHIP	4.7K	5%	1/10W
R510	VARIANT (SEE VARIANT PARTS LIST)					R573	1-216-829-11	RES-CHIP	4.7K	5%	1/10W
R512-R513	VARIANT (SEE VARIANT PARTS LIST)					R574	1-216-833-11	RES-CHIP	10K	5%	1/10W
R514	1-215-910-00	METAL OXIDE	68	5%	3W	R575	1-249-389-11	CARBON	4.7	5%	1/4W
R515	VARIANT (SEE VARIANT PARTS LIST)					R578	1-249-429-11	CARBON	10K	5%	1/4W
R520	1-216-833-11	RES-CHIP	10K	5%	1/10W	R581	1-249-441-11	CARBON	100K	5%	1/4W
						R583	1-249-377-11	CARBON	0.47	5%	1/4W



NOTE: The components identified by shading and  mark are critical FOR safety. Replace ONLY with part number specified.

NOTE: Les composants identifiés par un trame et une  sont critiques pour la sécurité. Ne les remplacer que par une pièce portant le numéro spécifique.

COMMON PARTS LIST



REF. NO.	PART NO.	DESCRIPTION	VALUES		
R584	1-215-453-00	METAL	22K	1%	1/4W
R585	VARIANT (SEE VARIANT PARTS LIST)				
R586	1-215-429-00	METAL	2.2K	1%	1/4W
R587	1-249-401-11	CARBON	47	5%	1/4W
R588	1-215-882-00	METAL OXIDE	22	5%	2W
 R589	1-247-895-91	CARBON	470K	5%	1/4W
 R590	1-249-429-11	CARBON	10K	5%	1/4W
 R591	1-216-365-00	METAL OXIDE	0.47	5%	2W
 R592	1-249-441-11	CARBON	100K	5%	1/4W
 R593	1-249-429-11	CARBON	10K	5%	1/4W
R594	VARIANT (SEE VARIANT PARTS LIST)				
 R595	1-247-895-91	CARBON	470K	5%	1/4W
R596	1-249-377-11	CARBON	0.47	5%	1/4W
R597	1-216-849-11	RES-CHIP	220K	5%	1/10W
R598	1-249-377-11	CARBON	0.47	5%	1/4W
R600	1-219-512-11	CARBON	2.2M	5%	1/2W
R601-R603	VARIANT (SEE VARIANT PARTS LIST)				
R604	1-216-821-11	RES-CHIP	1K	5%	1/10W
R605	1-216-833-11	RES-CHIP	10K	5%	1/10W
R606	1-216-833-11	RES-CHIP	10K	5%	1/10W
R607	1-216-857-11	RES-CHIP	1M	5%	1/10W
R608	1-215-924-00	METAL OXIDE	15K	5%	3W
R609	1-240-251-11	CEMENTED	6.8	5%	10W
R612	1-260-131-11	CARBON	470K	5%	1/2W
R614	1-216-825-11	RES-CHIP	2.2K	5%	1/10W
R615	1-202-933-61	FUSIBLE	0.1	10%	1/2W
R616	1-216-821-11	RES-CHIP	1K	5%	1/10W
R617	1-216-821-11	RES-CHIP	1K	5%	1/10W
R619	1-249-377-11	CARBON	0.47	5%	1/4W
R620	1-216-353-00	METAL OXIDE	2.2	5%	1W
R625	1-216-817-11	RES-CHIP	470	5%	1/10W
R626	1-218-715-11	METAL CHIP	9.1K	0.50%	1/16W
R627	1-215-481-00	METAL	330K	1%	1/4W
R628	1-260-131-11	CARBON	470K	5%	1/2W
R629	1-215-481-00	METAL	330K	1%	1/4W
R630	1-215-481-00	METAL	330K	1%	1/4W
R631	VARIANT (SEE VARIANT PARTS LIST)				
R632	1-216-809-11	RES-CHIP	100	5%	1/10W
R634	1-215-907-11	METAL OXIDE	22	5%	3W
R640	1-249-417-11	CARBON	1K	5%	1/4W
R647	1-216-811-11	RES-CHIP	150	5%	1/10W
R650	1-249-415-11	CARBON	680	5%	1/4W
R658	1-249-393-11	CARBON	10	5%	1/4W
R659	1-249-393-11	CARBON	10	5%	1/4W

REF. NO.	PART NO.	DESCRIPTION	VALUES		
R660	1-216-833-11	RES-CHIP	10K	5%	1/10W
R667	1-216-833-11	RES-CHIP	10K	5%	1/10W
 R668	1-249-418-11	CARBON	1.2K	5%	1/4W
R670	1-216-833-11	RES-CHIP	10K	5%	1/10W
R671	1-243-979-71	METAL OXIDE	0.1	5%	2W
R680	1-216-864-11	SHORT			
R687	VARIANT (SEE VARIANT PARTS LIST)				
R699	VARIANT (SEE VARIANT PARTS LIST)				
R850	1-215-451-00	METAL	18K	1%	1/4W
R851	1-216-821-11	RES-CHIP	1K	5%	1/10W
R852	VARIANT (SEE VARIANT PARTS LIST)				
R862	1-216-813-11	RES-CHIP	220	5%	1/10W
RELAY					
RY501	1-755-198-11	RELAY			
 RY600	1-755-395-11	RELAY(AC POWER)			
SWITCH					
S001	VARIANT (SEE VARIANT PARTS LIST)				
S002	1-692-431-21	SWITCH TACTILE			
S003	1-692-431-21	SWITCH TACTILE			
S004	1-692-431-21	SWITCH TACTILE			
S005	1-692-431-21	SWITCH TACTILE			
S006	1-692-431-21	SWITCH TACTILE			
S007	1-762-816-11	SWITCH TACTILE			
S008	1-762-816-11	SWITCH TACTILE			
SWITCH LEVER					
SW515	1-572-707-11	SWITCH LEVER			
TRANSFORMER					
T505	1-433-836-11	TRANSFORMER, HORIZONTAL DRIVE			
T510	VARIANT (SEE VARIANT PARTS LIST)				
T511	VARIANT (SEE VARIANT PARTS LIST)				
T585	VARIANT (SEE VARIANT PARTS LIST)				
T601-T603	VARIANT (SEE VARIANT PARTS LIST)				
THERMISTOR					
THP501	VARIANT (SEE VARIANT PARTS LIST)				
TUNER					
TU101	VARIANT (SEE VARIANT PARTS LIST)				
VARIATOR					
VDR600	VARIANT (SEE VARIANT PARTS LIST)				
CRYSTAL					
X001	1-795-006-21	OSCILLATOR, CRYSTAL			
X301	1-781-377-11	VIBRATOR, CRYSTAL			

NOTE: The components identified by shading and \triangle mark are critical FOR safety. Replace ONLY with part number specified.

NOTE: Les composants identifiés par un trame et une marque \triangle sont critiques pour la sécurité. Ne les remplacer que par une pièce portant le numéro spécifié.

VARIANT PARTS LIST



The parts on this page belong to the following model(s) ONLY:
KV-20FS100/21FS100(N)

REF. NO.	PART NO.	DESCRIPTION	VALUES			REF. NO.	PART NO.	DESCRIPTION	VALUES		
CAPACITOR						DIODE					
C001	1-164-230-11	CERAMIC CHIP	220pF	5%	50V	D001	8-719-070-80	DIODE LNK0120022G			
C066	1-126-947-11	ELECT	47 μ F	20%	25V	D200	8-719-929-15	DIODE MTZJ-T-77-9.1B			
C200	1-107-826-11	CERAMIC CHIP	0.1 μ F	10%	16V	D203	8-719-929-15	DIODE MTZJ-T-77-9.1B			
C202	1-107-826-11	CERAMIC CHIP	0.1 μ F	10%	16V	D204	8-719-929-15	DIODE MTZJ-T-77-9.1B			
C203	1-107-826-11	CERAMIC CHIP	0.1 μ F	10%	16V	D205	8-719-929-15	DIODE MTZJ-T-77-9.1B			
C204	1-107-826-11	CERAMIC CHIP	0.1 μ F	10%	16V	D234	8-719-108-12	DIODE RD9.1EW-T1			
C205	1-107-826-11	CERAMIC CHIP	0.1 μ F	10%	16V	D235	8-719-108-12	DIODE RD9.1EW-T1			
C206	1-126-963-11	ELECT	4.7 μ F	20%	50V	D236	8-719-108-12	DIODE RD9.1EW-T1			
C207	1-126-963-11	ELECT	4.7 μ F	20%	50V	D506	8-719-979-85	DIODE RGP15GPKG23			
C212	1-126-968-11	ELECT	100 μ F	20%	50V	D596	8-719-908-03	DIODE GP08DPKG23			
C213	1-126-968-11	ELECT	100 μ F	20%	50V	D598	8-719-908-03	DIODE GP08DPKG23			
C220	1-107-826-11	CERAMIC CHIP	0.1 μ F	10%	16V	D612	8-719-068-00	DIODE ERC04-06SE			
C305	1-107-826-11	CERAMIC CHIP	0.1 μ F	10%	16V	D613	8-719-068-00	DIODE ERC04-06SE			
C306	1-107-826-11	CERAMIC CHIP	0.1 μ F	10%	16V	FUSE					
C307	1-107-826-11	CERAMIC CHIP	0.1 μ F	10%	16V	\triangle F601	1-576-193-11	FUSE	6.3A/125V		
C360	1-164-230-11	CERAMIC CHIP	220pF	5%	50V	IC					
C361	1-164-230-11	CERAMIC CHIP	220pF	5%	50V	IC004	8-742-212-20	HYB, IC SBX3081-71			
C362	1-162-964-11	CERAMIC CHIP	0.001 μ F	10%	50V	IC401	6-701-105-01	IC NJM2750M-TE2			
C363	1-162-964-11	CERAMIC CHIP	0.001 μ F	10%	50V	IC404	6-701-104-01	IC AN17820A			
C370	1-162-969-11	CERAMIC CHIP	0.0068 μ F	10%	25V	IC545	8-759-835-98	IC AN5522			
C424	1-126-960-11	ELECT	1 μ F	20%	50V	JACK					
C452	1-126-933-11	ELECT	100 μ F	20%	16V	J200	1-794-118-11	JACK BLOCK, PIN	3P		
C454	1-164-677-11	CERAMIC CHIP	0.033 μ F	10%	16V	J201	1-794-048-11	JACK, PIN	3P		
C455	1-164-677-11	CERAMIC CHIP	0.033 μ F	10%	16V	J202	1-794-116-11	JACK BLOCK, PIN	2P		
C457	1-137-378-11	MYLAR	0.22 μ F	5%	50V	J206	1-794-117-11	JACK BLOCK, PIN	3P		
C458	1-137-378-11	MYLAR	0.22 μ F	5%	50V	COIL					
C459	1-137-194-91	FILM	0.47 μ F	5%	50V	L360	1-412-029-11	INDUCTOR	10 μ H		
C460	1-137-194-91	FILM	0.47 μ F	5%	50V	L361	1-412-029-11	INDUCTOR	10 μ H		
C499	1-126-965-91	ELECT	22 μ F	20%	50V	\triangle L510	1-406-981-21	INDUCTOR	470 μ H		
\triangle C506	1-117-214-11	CERAMIC	0.001 μ F	10%	2KV	IC LINK					
\triangle C507	1-117-642-11	FILM	8200pF	3%	1.2KV	PS401	1-576-336-21	LINK, IC			
\triangle C508	1-129-722-00	FILM	0.047 μ F	5%	630V	TRANSISTOR					
C511	1-115-521-11	FILM	0.82 μ F	5%	250V	Q404	8-729-422-27	TRANSISTOR 2SD601A-QRS-TX			
C514	1-115-519-11	FILM	0.56 μ F	5%	250V	Q405	8-729-422-27	TRANSISTOR 2SD601A-QRS-TX			
C523	1-136-346-51	MYLAR	0.22 μ F	20%	125V	\triangle Q506	6-550-042-01	TRANSISTOR 2SD2627LS-YB11			
C536	1-162-964-11	CERAMIC CHIP	0.001 μ F	10%	50V	Q600	8-729-052-29	TRANSISTOR 2SK2876-01MR-F122			
\triangle C602	1-136-311-51	MYLAR	0.47 μ F	20%	125V	Q601	8-729-052-29	TRANSISTOR 2SK2876-01MR-F122			
\triangle C603	1-136-311-51	MYLAR	0.47 μ F	20%	125V						
C621	1-165-921-11	ELECT	390 μ F	20%	250V						
C629	1-165-921-11	ELECT	390 μ F	20%	250V						
C672	1-135-871-21	FILM	15000pF	3%	800V						

VARIANT PARTS LIST



NOTE: The components identified by shading and \triangle mark are critical FOR safety. Replace ONLY with part number specified.

NOTE: Les composants identifiés par un trame et une marque \triangle sont critiques pour la sécurité. Ne les remplacer que par une pièce portant le numéro spécifié.

The parts on this page belong to the following model(s) ONLY:
KV-20FS100/21FS100(N)

REF. NO.	PART NO.	DESCRIPTION	VALUES			REF. NO.	PART NO.	DESCRIPTION	VALUES		
RESISTOR						R462	1-216-825-11	RES-CHIP	2.2K	5%	1/10W
R001	1-216-813-11	RES-CHIP	220	5%	1/10W	R487	1-216-837-11	RES-CHIP	22K	5%	1/10W
R029	1-249-409-11	CARBON	220	5%	1/4W	R488	1-216-837-11	RES-CHIP	22K	5%	1/10W
R030	1-249-409-11	CARBON	220	5%	1/4W	R489	1-216-805-11	RES-CHIP	47	5%	1/10W
R032	1-216-813-11	RES-CHIP	220	5%	1/10W	R490	1-216-805-11	RES-CHIP	47	5%	1/10W
R036	1-216-829-11	RES-CHIP	4.7K	5%	1/10W	R499	1-218-700-11	METAL CHIP	2.2K	0.50%	1/16W
R060	1-249-409-11	CARBON	220	5%	1/4W	R503	1-215-921-11	METAL OXIDE	4.7K	5%	3W
R079	1-216-864-11	SHORT				R510	1-260-320-11	CARBON	220	5%	1/2W
R085	1-216-864-11	SHORT				R512	1-215-910-00	METAL OXIDE	68	5%	3W
R101	1-216-829-11	RES-CHIP	4.7K	5%	1/10W	R513	1-215-913-11	METAL OXIDE	220	5%	3W
R105	1-216-864-11	SHORT				R515	1-215-886-11	METAL OXIDE	100	5%	2W
R109	1-216-829-11	RES-CHIP	4.7K	5%	1/10W	\triangle R528	1-218-867-11	RES-CHIP	6.8K	5%	1/10W
R111	1-216-829-11	RES-CHIP	4.7K	5%	1/10W	R529	1-216-837-11	RES-CHIP	22K	5%	1/10W
R200	1-216-841-11	RES-CHIP	47K	5%	1/10W	R533	1-216-826-11	RES-CHIP	2.7K	5%	1/10W
R202	1-216-845-11	RES-CHIP	100K	5%	1/10W	R535	1-216-825-11	RES-CHIP	2.2K	5%	1/10W
R203	1-216-845-11	RES-CHIP	100K	5%	1/10W	R536	1-216-833-11	RES-CHIP	10K	5%	1/10W
R204	1-249-437-11	CARBON	47K	5%	1/4W	R537	1-216-855-11	RES-CHIP	680K	5%	1/10W
R205	1-216-841-11	RES-CHIP	47K	5%	1/10W	R541	1-215-449-00	METAL	15K	1%	1/4W
R206	1-216-845-11	RES-CHIP	100K	5%	1/10W	R548	1-218-720-11	METAL CHIP	15K	0.50%	1/16W
R207	1-216-845-11	RES-CHIP	100K	5%	1/10W	R549	1-216-837-11	RES-CHIP	22K	5%	1/10W
R208	1-249-437-11	CARBON	47K	5%	1/4W	R585	1-215-453-00	METAL	22K	1%	1/4W
R209	1-249-437-11	CARBON	47K	5%	1/4W	\triangle R594	1-249-417-11	CARBON	1K	5%	1/4W
R210	1-216-845-11	RES-CHIP	100K	5%	1/10W	R601	1-205-998-11	CEMENTED	1	5%	10W
R211	1-249-437-11	CARBON	47K	5%	1/4W	R602	1-202-961-11	CEMENTED	1.8	5%	10W
R212	1-249-437-11	CARBON	47K	5%	1/4W	\triangle R603	1-219-513-11	CARBON	4.7M	5%	1/2W
R213	1-216-845-11	RES-CHIP	100K	5%	1/10W	R631	1-218-716-11	METAL CHIP	10K	0.50%	1/16W
R220	1-216-841-11	RES-CHIP	47K	5%	1/10W	R687	1-202-961-11	CEMENTED	1.8	5%	10W
R250	1-216-864-11	SHORT				SWITCH					
R251	1-216-864-11	SHORT				S001	1-692-431-21	SWITCH TACTILE			
R305	1-218-285-11	RES-CHIP	75	5%	1/10W	TRANSFORMER					
R306	1-218-285-11	RES-CHIP	75	5%	1/10W	\triangle T511	1-435-079-11	TRANSFORMER,HORIZONTAL,LINEAR			
R307	1-218-285-11	RES-CHIP	75	5%	1/10W	\triangle T585	1-453-316-21	FBT ASSY NX-1748//X4A4			
R360	1-216-809-11	RES-CHIP	100	5%	1/10W	\triangle T601	1-435-617-11	TRANSFORMER, LINE FILTER			
R361	1-216-809-11	RES-CHIP	100	5%	1/10W	\triangle T602	1-435-675-11	TRANSFORMER, STANDBY			
R410	1-216-864-11	SHORT				\triangle T603	1-437-609-11	POWER ISOLATION TRANSFORMER			
R413	1-216-864-11	SHORT				THERMISTOR					
R455	1-216-821-11	RES-CHIP	1K	5%	1/10W	THP501	1-809-539-11	THERMISTOR, POSITIVE			
R456	1-216-821-11	RES-CHIP	1K	5%	1/10W	TUNER					
R457	1-216-821-11	RES-CHIP	1K	5%	1/10W	\triangle TU101	8-598-593-00	TUNER, FSS BTF-WA421			
R458	1-216-821-11	RES-CHIP	1K	5%	1/10W	VARISTOR					
R459	1-216-817-11	RES-CHIP	470	5%	1/10W	VDR600	1-803-585-11	VARISTOR ENE271D-10A			
R460	1-216-817-11	RES-CHIP	470	5%	1/10W						
R461	1-216-825-11	RES-CHIP	2.2K	5%	1/10W						

VARIANT PARTS LIST





NOTE: The components identified by shading and mark are critical FOR safety. Replace ONLY with part number specified.

NOTE: Les composants identifiés par un trame et une marque sont critiques pour la securite. Ne les remplacer que par une piece portant le numero specifie.

The parts on this page belong to the following model(s) ONLY:
KV-21FS100(S)









REF. NO.	PART NO.	DESCRIPTION	VALUES			REF. NO.	PART NO.	DESCRIPTION	VALUES			
CAPACITOR						DIODE						
C001	1-164-230-11	CERAMIC CHIP	220pF	5%	50V	D001	8-719-070-80	DIODE LNK0120022G				
C066	1-126-947-11	ELECT	47µF	20%	25V	D200	8-719-929-15	DIODE MTZJ-T-77-9.1B				
C200	1-107-826-11	CERAMIC CHIP	0.1µF	10%	16V	D203	8-719-929-15	DIODE MTZJ-T-77-9.1B				
C202	1-107-826-11	CERAMIC CHIP	0.1µF	10%	16V	D204	8-719-929-15	DIODE MTZJ-T-77-9.1B				
C203	1-107-826-11	CERAMIC CHIP	0.1µF	10%	16V	D205	8-719-929-15	DIODE MTZJ-T-77-9.1B				
C204	1-107-826-11	CERAMIC CHIP	0.1µF	10%	16V	D234	8-719-108-12	DIODE RD9.1EW-T1				
C205	1-107-826-11	CERAMIC CHIP	0.1µF	10%	16V	D235	8-719-108-12	DIODE RD9.1EW-T1				
C206	1-126-963-11	ELECT	4.7µF	20%	50V	D236	8-719-108-12	DIODE RD9.1EW-T1				
C207	1-126-963-11	ELECT	4.7µF	20%	50V	D506	8-719-979-85	DIODE RGP15GPKG23				
C212	1-126-968-11	ELECT	100µF	20%	50V	D596	8-719-908-03	DIODE GP08DPKG23				
C213	1-126-968-11	ELECT	100µF	20%	50V	D598	8-719-908-03	DIODE GP08DPKG23				
C220	1-107-826-11	CERAMIC CHIP	0.1µF	10%	16V	FUSE						
C305	1-107-826-11	CERAMIC CHIP	0.1µF	10%	16V		F601	1-532-506-51	FUSE	6.3A/250V		
C306	1-107-826-11	CERAMIC CHIP	0.1µF	10%	16V	IC						
C307	1-107-826-11	CERAMIC CHIP	0.1µF	10%	16V	IC004	8-742-212-20	HYB, IC SBX3081-71				
C360	1-164-230-11	CERAMIC CHIP	220pF	5%	50V	IC401	6-701-105-01	IC NJM2750M-TE2				
C361	1-164-230-11	CERAMIC CHIP	220pF	5%	50V	IC404	6-701-104-01	IC AN17820A				
C362	1-162-964-11	CERAMIC CHIP	0.001µF	10%	50V	IC545	8-759-835-98	IC AN5522				
C363	1-162-964-11	CERAMIC CHIP	0.001µF	10%	50V	JACK						
C370	1-162-969-11	CERAMIC CHIP	0.0068µF	10%	25V	J200	1-794-118-11	JACK BLOCK, PIN	3P			
C424	1-126-960-11	ELECT	1µF	20%	50V	J201	1-794-048-11	JACK, PIN	3P			
C452	1-126-933-11	ELECT	100µF	20%	16V	J202	1-794-116-11	JACK BLOCK, PIN	2P			
C454	1-164-677-11	CERAMIC CHIP	0.033µF	10%	16V	J206	1-794-117-11	JACK BLOCK, PIN	3P			
C455	1-164-677-11	CERAMIC CHIP	0.033µF	10%	16V	COIL						
C457	1-137-378-11	MYLAR	0.22µF	5%	50V	L360	1-412-029-11	INDUCTOR	10µH			
C458	1-137-378-11	MYLAR	0.22µF	5%	50V	L361	1-412-029-11	INDUCTOR	10µH			
C459	1-137-194-91	FILM	0.47µF	5%	50V		L510	1-406-981-21	INDUCTOR	470µH		
C460	1-137-194-91	FILM	0.47µF	5%	50V	IC LINK						
C499	1-126-965-91	ELECT	22µF	20%	50V	PS401	1-576-336-21	LINK, IC				
	C506	1-117-214-11	CERAMIC	0.001µF	10%	2KV	TRANSISTOR					
	C507	1-117-642-11	FILM	8200pF	3%	1.2KV	Q404	8-729-422-27	TRANSISTOR 2SD601A-QRS-TX			
	C508	1-129-722-00	FILM	0.047µF	5%	630V	Q405	8-729-422-27	TRANSISTOR 2SD601A-QRS-TX			
	C511	1-115-521-11	FILM	0.82µF	5%	250V		Q506	6-550-042-01	TRANSISTOR 2SD2627LS-YB11		
	C514	1-115-519-11	FILM	0.56µF	5%	250V	Q600	8-729-052-29	TRANSISTOR 2SK2876-01MR-F122			
	C523	1-136-346-61	MYLAR	0.22µF	20%	300V	Q601	8-729-052-29	TRANSISTOR 2SK2876-01MR-F122			
	C536	1-162-964-11	CERAMIC CHIP	0.001µF	10%	50V	RESISTOR					
	C602	1-136-311-61	MYLAR	0.47µF	20%	300V	R001	1-216-813-11	RES-CHIP	220	5%	1/10W
	C603	1-136-311-61	MYLAR	0.47µF	20%	300V						
	C621	1-165-921-11	ELECT	390µF	20%	250V						
	C629	1-165-921-11	ELECT	390µF	20%	250V						
	C672	1-135-871-21	FILM	15000pF	3%	800V						

NOTE: The components identified by shading and  mark are critical FOR safety. Replace ONLY with part number specified.

NOTE: Les composants identifiés par un trame et une  sont critiques pour la sécurité. Ne les remplacer que par une pièce portant le numéro spécifié.

VARIANT PARTS LIST 

The parts on this page belong to the following model(s) ONLY:
KV-21FS100(S)

REF. NO.	PART NO.	DESCRIPTION	VALUES			REF. NO.	PART NO.	DESCRIPTION	VALUES		
R029	1-249-409-11	CARBON	220	5%	1/4W	R489	1-216-805-11	RES-CHIP	47	5%	1/10W
R030	1-249-409-11	CARBON	220	5%	1/4W	R490	1-216-805-11	RES-CHIP	47	5%	1/10W
R032	1-216-813-11	RES-CHIP	220	5%	1/10W	R499	1-218-700-11	METAL CHIP	2.2K	0.50%	1/16W
R036	1-216-829-11	RES-CHIP	4.7K	5%	1/10W	R503	1-215-921-11	METAL OXIDE	4.7K	5%	3W
R060	1-249-409-11	CARBON	220	5%	1/4W	R510	1-260-320-11	CARBON	220	5%	1/2W
R079	1-216-864-11	SHORT				R512	1-215-910-00	METAL OXIDE	68	5%	3W
R085	1-216-864-11	SHORT				R513	1-215-913-11	METAL OXIDE	220	5%	3W
R101	1-216-829-11	RES-CHIP	4.7K	5%	1/10W	R515	1-215-886-11	METAL OXIDE	100	5%	2W
R105	1-216-864-11	SHORT				 R528	1-218-867-11	RES-CHIP	6.8K	5%	1/10W
R109	1-216-829-11	RES-CHIP	4.7K	5%	1/10W	R529	1-216-837-11	RES-CHIP	22K	5%	1/10W
R111	1-216-829-11	RES-CHIP	4.7K	5%	1/10W	R533	1-216-826-11	RES-CHIP	2.7K	5%	1/10W
R200	1-216-841-11	RES-CHIP	47K	5%	1/10W	R535	1-216-825-11	RES-CHIP	2.2K	5%	1/10W
R202	1-216-845-11	RES-CHIP	100K	5%	1/10W	R536	1-216-833-11	RES-CHIP	10K	5%	1/10W
R203	1-216-845-11	RES-CHIP	100K	5%	1/10W	R537	1-216-855-11	RES-CHIP	680K	5%	1/10W
R204	1-249-437-11	CARBON	47K	5%	1/4W	R541	1-215-449-00	METAL	15K	1%	1/4W
R205	1-216-841-11	RES-CHIP	47K	5%	1/10W	R548	1-218-720-11	METAL CHIP	15K	0.50%	1/16W
R206	1-216-845-11	RES-CHIP	100K	5%	1/10W	R549	1-216-837-11	RES-CHIP	22K	5%	1/10W
R207	1-216-845-11	RES-CHIP	100K	5%	1/10W	R585	1-215-453-00	METAL	22K	1%	1/4W
R208	1-249-437-11	CARBON	47K	5%	1/4W	 R594	1-249-417-11	CARBON	1K	5%	1/4W
R209	1-249-437-11	CARBON	47K	5%	1/4W	R601	1-244-206-11	WIREWOUND	2.2	5%	10W
R210	1-216-845-11	RES-CHIP	100K	5%	1/10W	R602	1-244-206-11	WIREWOUND	2.2	5%	10W
R211	1-249-437-11	CARBON	47K	5%	1/4W	R631	1-218-716-11	METAL CHIP	10K	0.50%	1/16W
R212	1-249-437-11	CARBON	47K	5%	1/4W	R687	1-244-206-11	WIREWOUND	2.2	5%	10W
R213	1-216-845-11	RES-CHIP	100K	5%	1/10W	 R699	1-218-265-11	METAL	8.2M	5%	1W
R220	1-216-841-11	RES-CHIP	47K	5%	1/10W	SWITCH					
R250	1-216-864-11	SHORT				S001	1-692-431-21	SWITCH TACTILE			
R251	1-216-864-11	SHORT				TRANSFORMER					
R305	1-218-285-11	RES-CHIP	75	5%	1/10W	 T511	1-435-079-11	TRANSFORMER,HORIZONTAL DRIVE, LINEAR			
R306	1-218-285-11	RES-CHIP	75	5%	1/10W	 T585	1-453-316-21	FBT ASSY NX-1748//X4A4			
R307	1-218-285-11	RES-CHIP	75	5%	1/10W	 T601	1-426-717-11	TRANSFORMER,LINE FILTER			
R360	1-216-809-11	RES-CHIP	100	5%	1/10W	 T602	1-435-676-11	TRANSFORMER, STANDBY			
R361	1-216-809-11	RES-CHIP	100	5%	1/10W	 T603	1-437-609-11	POWER ISOLATION TRANSFORMER			
R410	1-216-864-11	SHORT				THERMISTOR					
R413	1-216-864-11	SHORT				THP501	1-803-540-11	THERMISTOR			
R455	1-216-821-11	RES-CHIP	1K	5%	1/10W	TUNER					
R456	1-216-821-11	RES-CHIP	1K	5%	1/10W	 TU101	8-598-593-00	TUNER, FSS BTF-WA421			
R457	1-216-821-11	RES-CHIP	1K	5%	1/10W	VARISTOR					
R458	1-216-821-11	RES-CHIP	1K	5%	1/10W	VDR600	1-803-967-11	VARISTOR (ENE621D-14A)			
R459	1-216-817-11	RES-CHIP	470	5%	1/10W						
R460	1-216-817-11	RES-CHIP	470	5%	1/10W						
R461	1-216-825-11	RES-CHIP	2.2K	5%	1/10W						
R462	1-216-825-11	RES-CHIP	2.2K	5%	1/10W						
R487	1-216-837-11	RES-CHIP	22K	5%	1/10W						
R488	1-216-837-11	RES-CHIP	22K	5%	1/10W						







NOTE: The components identified by shading and  mark are critical FOR safety. Replace ONLY with part number specified.

NOTE: Les composants identifiés par un trame et une marque  sont critiques pour la sécurité. Ne les remplacer que par une pièce portant le numéro spécifié.

VARIANT PARTS LIST



The parts on this page belong to the following model(s) ONLY:
KV-20FV300/21FV300(N)

REF. NO.	PART NO.	DESCRIPTION	VALUES			REF. NO.	PART NO.	DESCRIPTION	VALUES		
CAPACITOR						C457	1-126-963-11	ELECT	4.7μF	20%	50V
C069	1-126-964-11	ELECT	10μF	20%	50V	C458	1-126-963-11	ELECT	4.7μF	20%	50V
C200	1-107-826-11	CERAMIC CHIP	0.1μF	10%	16V	C461	1-127-715-91	CERAMIC CHIP	0.22μF	10%	16V
C202	1-107-826-11	CERAMIC CHIP	0.1μF	10%	16V	C462	1-127-715-91	CERAMIC CHIP	0.22μF	10%	16V
C203	1-107-826-11	CERAMIC CHIP	0.1μF	10%	16V	C463	1-127-715-91	CERAMIC CHIP	0.22μF	10%	16V
C204	1-107-826-11	CERAMIC CHIP	0.1μF	10%	16V	C464	1-127-715-91	CERAMIC CHIP	0.22μF	10%	16V
C205	1-107-826-11	CERAMIC CHIP	0.1μF	10%	16V	C499	1-126-963-11	ELECT	4.7μF	20%	50V
C206	1-126-963-11	ELECT	4.7μF	20%	50V	 C506	1-117-214-11	CERAMIC	0.001μF	10%	2KV
C207	1-126-963-11	ELECT	4.7μF	20%	50V	 C507	1-117-642-11	FILM	8200pF	3%	1.2KV
C212	1-126-963-11	ELECT	4.7μF	20%	50V	 C508	1-129-722-00	FILM	0.047μF	5%	630V
C213	1-126-963-11	ELECT	4.7μF	20%	50V	C511	1-115-521-11	FILM	0.82μF	5%	250V
C220	1-107-826-11	CERAMIC CHIP	0.1μF	10%	16V	C514	1-115-519-11	FILM	0.56μF	5%	250V
C301	1-126-956-91	ELECT	0.1μF	20%	50V	C523	1-136-346-51	MYLAR	0.22μF	20%	125V
C302	1-126-956-91	ELECT	0.1μF	20%	50V	C536	1-162-964-11	CERAMIC CHIP	0.001μF	10%	50V
C305	1-107-826-11	CERAMIC CHIP	0.1μF	10%	16V	 C602	1-136-311-51	MYLAR	0.47μF	20%	125V
C306	1-107-826-11	CERAMIC CHIP	0.1μF	10%	16V	 C603	1-136-311-51	MYLAR	0.47μF	20%	125V
C307	1-107-826-11	CERAMIC CHIP	0.1μF	10%	16V	C621	1-165-922-11	ELECT	470μF	20%	250V
C360	1-164-230-11	CERAMIC CHIP	220pF	5%	50V	C629	1-165-922-11	ELECT	470μF	20%	250V
C361	1-164-230-11	CERAMIC CHIP	220pF	5%	50V	C672	1-137-756-21	FILM	22000pF	3%	800V
C362	1-162-964-11	CERAMIC CHIP	0.001μF	10%	50V	CONNECTOR					
C363	1-162-964-11	CERAMIC CHIP	0.001μF	10%	50V	CN002	1-564-509-11	PLUG,CONNECTOR	6P		
C370	1-162-969-11	CERAMIC CHIP	0.0068μF	10%	25V	DIODE					
C400	1-128-934-91	CERAMIC CHIP	0.33μF	20%	10V	D200	8-719-929-15	DIODE MTZJ-T-77-9.1B			
C401	1-164-227-11	CERAMIC CHIP	0.022μF	10%	25V	D203	8-719-929-15	DIODE MTZJ-T-77-9.1B			
C402	1-164-174-11	CERAMIC CHIP	0.0082μF	10%	25V	D204	8-719-929-15	DIODE MTZJ-T-77-9.1B			
C403	1-162-967-11	CERAMIC CHIP	0.0033μF	10%	50V	D205	8-719-929-15	DIODE MTZJ-T-77-9.1B			
C404	1-162-967-11	CERAMIC CHIP	0.0033μF	10%	50V	D206	8-719-929-15	DIODE MTZJ-T-77-9.1B			
C405	1-164-677-11	CERAMIC CHIP	0.033μF	10%	16V	D208	8-719-929-15	DIODE MTZJ-T-77-9.1B			
C406	1-164-677-11	CERAMIC CHIP	0.033μF	10%	16V	D231	8-719-108-12	DIODE RD9.1EW-T1			
C407	1-162-965-11	CERAMIC CHIP	0.0015μF	10%	50V	D234	8-719-108-12	DIODE RD9.1EW-T1			
C408	1-162-965-11	CERAMIC CHIP	0.0015μF	10%	50V	D235	8-719-108-12	DIODE RD9.1EW-T1			
C409	1-127-715-91	CERAMIC CHIP	0.22μF	10%	16V	D236	8-719-108-12	DIODE RD9.1EW-T1			
C410	1-127-715-91	CERAMIC CHIP	0.22μF	10%	16V	D237	8-719-108-12	DIODE RD9.1EW-T1			
C411	1-128-934-91	CERAMIC CHIP	0.33μF	20%	10V	D506	8-719-979-85	DIODE RGP15GPKG23			
C412	1-126-960-11	ELECT	1μF	20%	50V	D596	8-719-908-03	DIODE GP08DPKG23			
C413	1-126-960-11	ELECT	1μF	20%	50V	D598	8-719-908-03	DIODE GP08DPKG23			
C414	1-126-961-11	ELECT	2.2μF	20%	50V	D612	8-719-068-00	DIODE ERC04-06SE			
C415	1-126-960-11	ELECT	1μF	20%	50V	D613	8-719-068-00	DIODE ERC04-06SE			
C416	1-126-960-11	ELECT	1μF	20%	50V	FUSE					
C418	1-126-963-11	ELECT	4.7μF	20%	50V	 F601	1-576-193-11	FUSE	6.3A/125V		
C420	1-126-960-11	ELECT	1μF	20%	50V						
C422	1-126-960-11	ELECT	1μF	20%	50V						
C452	1-126-967-11	ELECT	47μF	20%	50V						



NOTE: The components identified by shading and  mark are critical FOR safety. Replace ONLY with part number specified.

NOTE: Les composants identifiés par un trame et une marque  sont critiques pour la sécurité. Ne les remplacer que par une pièce portant le numéro spécifié.

VARIANT PARTS LIST



The parts on this page belong to the following model(s) ONLY:
KV-20FV300/21FV300(N)

REF. NO.	PART NO.	DESCRIPTION	VALUES			REF. NO.	PART NO.	DESCRIPTION	VALUES			
IC						R209	1-249-409-11	CARBON	220	5%	1/4W	
IC005	8-759-353-00	IC NJM2534M(TE2)				R210	1-216-845-11	RES-CHIP	100K	5%	1/10W	
IC400	6-701-106-01	IC NJW1134G-TE2				R211	1-249-409-11	CARBON	220	5%	1/4W	
IC404	6-701-107-01	IC AN7125Z				R212	1-249-409-11	CARBON	220	5%	1/4W	
IC545	8-759-835-98	IC AN5522				R213	1-216-845-11	RES-CHIP	100K	5%	1/10W	
JACK						R215	1-216-845-11	RES-CHIP	100K	5%	1/10W	
J200	1-794-119-11	TERMINAL BLOCK, S4P				R216	1-216-845-11	RES-CHIP	100K	5%	1/10W	
J201	1-794-048-11	JACK, PIN 3P				R217	1-249-409-11	CARBON	220	5%	1/4W	
J202	1-794-116-11	JACK BLOCK, PIN 2P				R218	1-249-409-11	CARBON	220	5%	1/4W	
J205	1-794-116-11	JACK BLOCK, PIN 2P				R220	1-216-813-11	RES-CHIP	220	5%	1/10W	
J206	1-794-117-11	JACK BLOCK, PIN 3P				R221	1-249-409-11	CARBON	220	5%	1/4W	
COIL						R222	1-249-409-11	CARBON	220	5%	1/4W	
L360	1-412-029-11	INDUCTOR	10μH			R227	1-218-285-11	RES-CHIP	75	5%	1/10W	
L361	1-412-029-11	INDUCTOR	10μH			R250	1-216-837-11	RES-CHIP	22K	5%	1/10W	
	L510	1-406-981-21	INDUCTOR	470μH		R251	1-216-837-11	RES-CHIP	22K	5%	1/10W	
IC LINK						R301	1-218-285-11	RES-CHIP	75	5%	1/10W	
PS401	1-576-337-21	LINK, IC				R305	1-218-285-11	RES-CHIP	75	5%	1/10W	
TRANSISTOR						R306	1-218-285-11	RES-CHIP	75	5%	1/10W	
	Q506	6-550-042-01	TRANSISTOR 2SD2627LS-YB11			R307	1-218-285-11	RES-CHIP	75	5%	1/10W	
Q600	8-729-053-36	TRANSISTOR 2SK2640-01MR-F122				R360	1-216-809-11	RES-CHIP	100	5%	1/10W	
Q601	8-729-053-36	TRANSISTOR 2SK2640-01MR-F122				R361	1-216-809-11	RES-CHIP	100	5%	1/10W	
RESISTOR						R400	1-216-829-11	RES-CHIP	4.7K	5%	1/10W	
R029	1-249-409-11	CARBON	220	5%	1/4W	R401	1-216-809-11	RES-CHIP	100	5%	1/10W	
R030	1-249-409-11	CARBON	220	5%	1/4W	R403	1-216-809-11	RES-CHIP	100	5%	1/10W	
R032	1-216-813-11	RES-CHIP	220	5%	1/10W	R427	1-216-829-11	RES-CHIP	4.7K	5%	1/10W	
R036	1-216-825-11	RES-CHIP	2.2K	5%	1/10W	R429	1-216-829-11	RES-CHIP	4.7K	5%	1/10W	
R046	1-249-409-11	CARBON	220	5%	1/4W	R431	1-216-789-11	RES-CHIP	2.2	5%	1/10W	
R060	1-249-409-11	CARBON	220	5%	1/4W	R432	1-216-789-11	RES-CHIP	2.2	5%	1/10W	
R101	1-216-829-11	RES-CHIP	4.7K	5%	1/10W	R433	1-216-789-11	RES-CHIP	2.2	5%	1/10W	
R105	1-216-864-11	SHORT				R434	1-216-789-11	RES-CHIP	2.2	5%	1/10W	
R109	1-216-829-11	RES-CHIP	4.7K	5%	1/10W	R461	1-216-845-11	RES-CHIP	100K	5%	1/10W	
R111	1-216-829-11	RES-CHIP	4.7K	5%	1/10W	R462	1-216-845-11	RES-CHIP	100K	5%	1/10W	
R200	1-216-813-11	RES-CHIP	220	5%	1/10W	R482	1-216-864-11	SHORT				
R202	1-216-845-11	RES-CHIP	100K	5%	1/10W	R499	1-216-833-11	RES-CHIP	10K	5%	1/10W	
R203	1-216-845-11	RES-CHIP	100K	5%	1/10W	R503	1-215-921-11	METAL OXIDE	4.7K	5%	3W	
R204	1-249-409-11	CARBON	220	5%	1/4W	R510	1-260-320-11	CARBON	220	5%	1/2W	
R206	1-216-845-11	RES-CHIP	100K	5%	1/10W	R512	1-215-910-00	METAL OXIDE	68	5%	3W	
R207	1-216-845-11	RES-CHIP	100K	5%	1/10W	R513	1-215-913-11	METAL OXIDE	220	5%	3W	
R208	1-249-409-11	CARBON	220	5%	1/4W	R515	1-215-886-11	METAL OXIDE	100	5%	2W	
							R528	1-218-867-11	RES-CHIP	6.8K	5%	1/10W
						R529	1-216-837-11	RES-CHIP	22K	5%	1/10W	
						R533	1-216-826-11	RES-CHIP	2.7K	5%	1/10W	
						R535	1-216-825-11	RES-CHIP	2.2K	5%	1/10W	
						R536	1-216-833-11	RES-CHIP	10K	5%	1/10W	









NOTE: The components identified by shading and  mark are critical FOR safety. Replace ONLY with part number specified.

NOTE: Les composants identifiés par un trame et une marque  sont critiques pour la securite. Ne les remplacer que par une piece portant le numero specifie.

VARIANT PARTS LIST



The parts on this page belong to the following model(s) ONLY:
KV-20FV300/21FV300(N)

REF. NO.	PART NO.	DESCRIPTION	VALUES			REF. NO.	PART NO.	DESCRIPTION	VALUES		
R537	1-216-855-11	RES-CHIP	680K	5%	1/10W						
R541	1-215-449-00	METAL	15K	1%	1/4W						
R548	1-218-720-11	METAL CHIP	15K	0.50%	1/16W						
R549	1-216-837-11	RES-CHIP	22K	5%	1/10W						
R585	1-215-453-00	METAL	22K	1%	1/4W						
 R594	1-249-417-11	CARBON	1K	5%	1/4W						
R601	1-240-262-11	CEMENTED	0.68	5%	10W						
R602	1-202-961-11	CEMENTED	1.8	5%	10W						
 R603	1-219-513-11	CARBON	4.7M	5%	1/2W						
R631	1-218-718-11	METAL CHIP	12K	0.50%	1/16W						
R687	1-202-961-11	CEMENTED	1.8	5%	10W						
TRANSFORMER											
 T511	1-435-079-11	TRANSFORMER, HORIZONTAL LINEAR									
 T585	1-453-316-21	FBT ASSY NX-1748//X4A4									
 T601	1-435-617-11	TRANSFORMER, LINE FILTER									
 T602	1-435-675-11	TRANSFORMER, STANDBY									
 T603	1-437-611-11	POWER ISOLATION TRANSFORMER									
THERMISTOR											
THP501	1-809-539-11	THERMISTOR, POSITIVE									
TUNER											
 TU101	8-598-593-00	TUNER, FSS BTF-WA421									
VARISTOR											
VDR600	1-803-585-11	VARISTOR ENE271D-10A									







NOTE: The components identified by shading and  mark are critical FOR safety. Replace ONLY with part number specified.

NOTE: Les composants identifiés par un trame et une marque  sont critiques pour la sécurité. Ne les remplacer que par une pièce portant le numéro spécifié.

VARIANT PARTS LIST



The parts on this page belong to the following model(s) ONLY:
KV-21FV300(S)

REF. NO.	PART NO.	DESCRIPTION	VALUES	REF. NO.	PART NO.	DESCRIPTION	VALUES
CAPACITOR				C457	1-126-963-11	ELECT	4.7µF 20% 50V
C069	1-126-964-11	ELECT	10µF 20% 50V	C458	1-126-963-11	ELECT	4.7µF 20% 50V
C200	1-107-826-11	CERAMIC CHIP	0.1µF 10% 16V	C461	1-127-715-91	CERAMIC CHIP	0.22µF 10% 16V
C202	1-107-826-11	CERAMIC CHIP	0.1µF 10% 16V	C462	1-127-715-91	CERAMIC CHIP	0.22µF 10% 16V
C203	1-107-826-11	CERAMIC CHIP	0.1µF 10% 16V	C463	1-127-715-91	CERAMIC CHIP	0.22µF 10% 16V
C204	1-107-826-11	CERAMIC CHIP	0.1µF 10% 16V	C464	1-127-715-91	CERAMIC CHIP	0.22µF 10% 16V
C205	1-107-826-11	CERAMIC CHIP	0.1µF 10% 16V	C499	1-126-963-11	ELECT	4.7µF 20% 50V
C206	1-126-963-11	ELECT	4.7µF 20% 50V	 C506	1-117-214-11	CERAMIC	0.001µF 10% 2KV
C207	1-126-963-11	ELECT	4.7µF 20% 50V	 C507	1-117-642-11	FILM	8200pF 3% 1.2KV
C212	1-126-963-11	ELECT	4.7µF 20% 50V	 C508	1-129-722-00	FILM	0.047µF 5% 630V
C213	1-126-963-11	ELECT	4.7µF 20% 50V	C511	1-115-521-11	FILM	0.82µF 5% 250V
C220	1-107-826-11	CERAMIC CHIP	0.1µF 10% 16V	C514	1-115-519-11	FILM	0.56µF 5% 250V
C301	1-126-956-91	ELECT	0.1µF 20% 50V	C523	1-136-346-61	MYLAR	0.22µF 20% 300V
C302	1-126-956-91	ELECT	0.1µF 20% 50V	C536	1-162-964-11	CERAMIC CHIP	0.001µF 10% 50V
C305	1-107-826-11	CERAMIC CHIP	0.1µF 10% 16V	 C602	1-136-311-61	MYLAR	0.47µF 20% 300V
C306	1-107-826-11	CERAMIC CHIP	0.1µF 10% 16V	 C603	1-136-311-61	MYLAR	0.47µF 20% 300V
C307	1-107-826-11	CERAMIC CHIP	0.1µF 10% 16V	C621	1-165-922-11	ELECT	470µF 20% 250V
C360	1-164-230-11	CERAMIC CHIP	220pF 5% 50V	C629	1-165-922-11	ELECT	470µF 20% 250V
C361	1-164-230-11	CERAMIC CHIP	220pF 5% 50V	C672	1-137-756-21	FILM	22000pF 3% 800V
C362	1-162-964-11	CERAMIC CHIP	0.001µF 10% 50V	CONNECTOR			
C363	1-162-964-11	CERAMIC CHIP	0.001µF 10% 50V	CN002	1-564-509-11	PLUG,CONNECTOR	6P
C370	1-162-969-11	CERAMIC CHIP	0.0068µF 10% 25V	DIODE			
C400	1-128-934-91	CERAMIC CHIP	0.33µF 20% 10V	D200	8-719-929-15	DIODE MTZJ-T-77-9.1B	
C401	1-164-227-11	CERAMIC CHIP	0.022µF 10% 25V	D203	8-719-929-15	DIODE MTZJ-T-77-9.1B	
C402	1-164-174-11	CERAMIC CHIP	0.0082µF 10% 25V	D204	8-719-929-15	DIODE MTZJ-T-77-9.1B	
C403	1-162-967-11	CERAMIC CHIP	0.0033µF 10% 50V	D205	8-719-929-15	DIODE MTZJ-T-77-9.1B	
C404	1-162-967-11	CERAMIC CHIP	0.0033µF 10% 50V	D206	8-719-929-15	DIODE MTZJ-T-77-9.1B	
C405	1-164-677-11	CERAMIC CHIP	0.033µF 10% 16V	D208	8-719-929-15	DIODE MTZJ-T-77-9.1B	
C406	1-164-677-11	CERAMIC CHIP	0.033µF 10% 16V	D231	8-719-108-12	DIODE RD9.1EW-T1	
C407	1-162-965-11	CERAMIC CHIP	0.0015µF 10% 50V	D234	8-719-108-12	DIODE RD9.1EW-T1	
C408	1-162-965-11	CERAMIC CHIP	0.0015µF 10% 50V	D235	8-719-108-12	DIODE RD9.1EW-T1	
C409	1-127-715-91	CERAMIC CHIP	0.22µF 10% 16V	D236	8-719-108-12	DIODE RD9.1EW-T1	
C410	1-127-715-91	CERAMIC CHIP	0.22µF 10% 16V	D237	8-719-108-12	DIODE RD9.1EW-T1	
C411	1-128-934-91	CERAMIC CHIP	0.33µF 20% 10V	D506	8-719-979-85	DIODE RGP15GPKG23	
C412	1-126-960-11	ELECT	1µF 20% 50V	D596	8-719-908-03	DIODE GP08DPKG23	
C413	1-126-960-11	ELECT	1µF 20% 50V	D598	8-719-908-03	DIODE GP08DPKG23	
C414	1-126-961-11	ELECT	2.2µF 20% 50V	FUSE			
C415	1-126-960-11	ELECT	1µF 20% 50V	 F601	1-532-506-51	FUSE	6.3A/250V
C416	1-126-960-11	ELECT	1µF 20% 50V				
C418	1-126-963-11	ELECT	4.7µF 20% 50V				
C420	1-126-960-11	ELECT	1µF 20% 50V				
C422	1-126-960-11	ELECT	1µF 20% 50V				
C452	1-126-967-11	ELECT	47µF 20% 50V				

NOTE: The components identified by shading and \triangle mark are critical FOR safety. Replace ONLY with part number specified.

NOTE: Les composants identifiés par un trame et une marque \triangle sont critiques pour la sécurité. Ne les remplacer que par une pièce portant le numéro spécifié.

VARIANT PARTS LIST



The parts on this page belong to the following model(s) ONLY:
KV-21FV300(S)

REF. NO.	PART NO.	DESCRIPTION	VALUES	REF. NO.	PART NO.	DESCRIPTION	VALUES
IC				R209	1-249-409-11	CARBON	220 5% 1/4W
IC005	8-759-353-00	IC NJM2534M(Te2)		R210	1-216-845-11	RES-CHIP	100K 5% 1/10W
IC400	6-701-106-01	IC NJW1134G-TE2		R211	1-249-409-11	CARBON	220 5% 1/4W
IC404	6-701-107-01	IC AN7125Z		R212	1-249-409-11	CARBON	220 5% 1/4W
IC545	8-759-835-98	IC AN5522		R213	1-216-845-11	RES-CHIP	100K 5% 1/10W
JACK				R215	1-216-845-11	RES-CHIP	100K 5% 1/10W
J200	1-794-119-11	TERMINAL BLOCK, S	4P	R216	1-216-845-11	RES-CHIP	100K 5% 1/10W
J201	1-794-048-11	JACK, PIN	3P	R217	1-249-409-11	CARBON	220 5% 1/4W
J202	1-794-116-11	JACK BLOCK, PIN	2P	R218	1-249-409-11	CARBON	220 5% 1/4W
J205	1-794-116-11	JACK BLOCK, PIN	2P	R220	1-216-813-11	RES-CHIP	220 5% 1/10W
J206	1-794-117-11	JACK BLOCK, PIN	3P	R221	1-249-409-11	CARBON	220 5% 1/4W
COIL				R222	1-249-409-11	CARBON	220 5% 1/4W
L360	1-412-029-11	INDUCTOR	10 μ H	R227	1-218-285-11	RES-CHIP	75 5% 1/10W
L361	1-412-029-11	INDUCTOR	10 μ H	R250	1-216-837-11	RES-CHIP	22K 5% 1/10W
\triangle L510	1-406-981-21	INDUCTOR	470 μ H	R251	1-216-837-11	RES-CHIP	22K 5% 1/10W
IC LINK				R301	1-218-285-11	RES-CHIP	75 5% 1/10W
PS401	1-576-337-21	LINK, IC		R305	1-218-285-11	RES-CHIP	75 5% 1/10W
TRANSISTOR				R306	1-218-285-11	RES-CHIP	75 5% 1/10W
\triangle Q506	6-550-042-01	TRANSISTOR 2SD2627LS-YB11		R307	1-218-285-11	RES-CHIP	75 5% 1/10W
Q600	8-729-053-36	TRANSISTOR 2SK2640-01MR-F122		R360	1-216-809-11	RES-CHIP	100 5% 1/10W
Q601	8-729-053-36	TRANSISTOR 2SK2640-01MR-F122		R361	1-216-809-11	RES-CHIP	100 5% 1/10W
RESISTOR				R400	1-216-829-11	RES-CHIP	4.7K 5% 1/10W
R029	1-249-409-11	CARBON	220 5% 1/4W	R401	1-216-809-11	RES-CHIP	100 5% 1/10W
R030	1-249-409-11	CARBON	220 5% 1/4W	R403	1-216-809-11	RES-CHIP	100 5% 1/10W
R032	1-216-813-11	RES-CHIP	220 5% 1/10W	R427	1-216-829-11	RES-CHIP	4.7K 5% 1/10W
R036	1-216-825-11	RES-CHIP	2.2K 5% 1/10W	R429	1-216-829-11	RES-CHIP	4.7K 5% 1/10W
R046	1-249-409-11	CARBON	220 5% 1/4W	R431	1-216-789-11	RES-CHIP	2.2 5% 1/10W
R060	1-249-409-11	CARBON	220 5% 1/4W	R432	1-216-789-11	RES-CHIP	2.2 5% 1/10W
R101	1-216-829-11	RES-CHIP	4.7K 5% 1/10W	R433	1-216-789-11	RES-CHIP	2.2 5% 1/10W
R105	1-216-864-11	SHORT		R434	1-216-789-11	RES-CHIP	2.2 5% 1/10W
R109	1-216-829-11	RES-CHIP	4.7K 5% 1/10W	R461	1-216-845-11	RES-CHIP	100K 5% 1/10W
R111	1-216-829-11	RES-CHIP	4.7K 5% 1/10W	R462	1-216-845-11	RES-CHIP	100K 5% 1/10W
R200	1-216-813-11	RES-CHIP	220 5% 1/10W	R482	1-216-864-11	SHORT	
R202	1-216-845-11	RES-CHIP	100K 5% 1/10W	R499	1-216-833-11	RES-CHIP	10K 5% 1/10W
R203	1-216-845-11	RES-CHIP	100K 5% 1/10W	R503	1-215-921-11	METAL OXIDE	4.7K 5% 3W
R204	1-249-409-11	CARBON	220 5% 1/4W	R510	1-260-320-11	CARBON	220 5% 1/2W
R206	1-216-845-11	RES-CHIP	100K 5% 1/10W	R512	1-215-910-00	METAL OXIDE	68 5% 3W
R207	1-216-845-11	RES-CHIP	100K 5% 1/10W	R513	1-215-913-11	METAL OXIDE	220 5% 3W
R208	1-249-409-11	CARBON	220 5% 1/4W	R515	1-215-886-11	METAL OXIDE	100 5% 2W
				\triangle R528	1-218-867-11	RES-CHIP	6.8K 5% 1/10W
				R529	1-216-837-11	RES-CHIP	22K 5% 1/10W
				R533	1-216-826-11	RES-CHIP	2.7K 5% 1/10W
				R535	1-216-825-11	RES-CHIP	2.2K 5% 1/10W
				R536	1-216-833-11	RES-CHIP	10K 5% 1/10W









NOTE: The components identified by shading and  mark are critical FOR safety. Replace ONLY with part number specified.

NOTE: Les composants identifiés par un trame et une marque  sont critiques pour la securite. Ne les remplacer que par une piece portant le numero specifie.

VARIANT PARTS LIST



The parts on this page belong to the following model(s) ONLY:
KV-21FV300(S)

REF. NO.	PART NO.	DESCRIPTION	VALUES			REF. NO.	PART NO.	DESCRIPTION	VALUES		
R537	1-216-855-11	RES-CHIP	680K	5%	1/10W						
R541	1-215-449-00	METAL	15K	1%	1/4W						
R548	1-218-720-11	METAL CHIP	15K	0.50%	1/16W						
R549	1-216-837-11	RES-CHIP	22K	5%	1/10W						
R585	1-215-453-00	METAL	22K	1%	1/4W						
 R594	1-249-417-11	CARBON	1K	5%	1/4W						
R601	1-244-206-11	WIREWOUND	2.2	5%	10W						
R602	1-244-206-11	WIREWOUND	2.2	5%	10W						
R631	1-218-718-11	METAL CHIP	12K	0.50%	1/16W						
R687	1-244-206-11	WIREWOUND	2.2	5%	10W						
 R699	1-218-265-11	METAL	8.2M	5%	1W						
TRANSFORMER											
 T511	1-435-079-11	TRANSFORMER, HORIZONTAL LINEAR									
 T585	1-453-316-21	FBT ASSY NX-1748//X4A4									
 T601	1-426-717-11	TRANSFORMER, LINE FILTER (LFT)									
 T602	1-435-676-11	TRANSFORMER, STANDBY									
 T603	1-437-611-11	POWER ISOLATION TRANSFORMER									
THERMISTOR											
THP501	1-803-540-11	THERMISTOR									
TUNER											
 TU101	8-598-593-00	TUNER, FSS BTF-WA421									
VARISTOR											
VDR600	1-803-967-11	VARISTOR (ENE621D-14A)									

NOTE: The components identified by shading and \triangle mark are critical FOR safety. Replace ONLY with part number specified.

NOTE: Les composants identifiés par un trame et une marque \triangle sont critiques pour la sécurité. Ne les remplacer que par une pièce portant le numéro spécifié.

VARIANT PARTS LIST



The parts on this page belong to the following model(s) ONLY:
KV-21FM100(N)

REF. NO.	PART NO.	DESCRIPTION	VALUES	REF. NO.	PART NO.	DESCRIPTION	VALUES
CAPACTIOR							
C001	1-164-230-11	CERAMIC CHIP	220pF 5% 50V	IC402	8-759-450-93	IC NJM2521M-TE1	
C066	1-126-947-11	ELECT	47 μ F 20% 25V	IC404	6-701-104-01	IC AN17820A	
C200	1-113-619-11	CERAMIC CHIP	0.47 μ F 10V	IC545	8-759-835-98	IC AN5522	
C203	1-113-619-11	CERAMIC CHIP	0.47 μ F 10V	JACK			
C204	1-113-619-11	CERAMIC CHIP	0.47 μ F 10V	J200	1-794-115-11	JACK BLOCK PIN	2P
C212	1-126-968-11	ELECT	100 μ F 20% 50V	J201	1-580-441-41	JACK, PIN	2P
C213	1-126-968-11	ELECT	100 μ F 20% 50V	COIL			
C370	1-162-969-11	CERAMIC CHIP	0.0068 μ F 10% 25V	\triangle L510	1-406-981-21	INDUCTOR	470 μ H
C452	1-126-933-11	ELECT	100 μ F 20% 16V	IC LINK			
C454	1-164-677-11	CERAMIC CHIP	0.033 μ F 10% 16V	PS401	1-576-336-21	LINK, IC	
C455	1-164-677-11	CERAMIC CHIP	0.033 μ F 10% 16V	TRANSISTOR			
C457	1-137-378-11	MYLAR	0.22 μ F 5% 50V	Q404	8-729-422-27	TRANSISTOR 2SD601A-QRS-TX	
C458	1-137-378-11	MYLAR	0.22 μ F 5% 50V	Q405	8-729-422-27	TRANSISTOR 2SD601A-QRS-TX	
C459	1-137-194-91	FILM	0.47 μ F 5% 50V	\triangle Q506	6-550-042-01	TRANSISTOR 2SD2627LS-YB11	
C460	1-137-194-91	FILM	0.47 μ F 5% 50V	Q600	8-729-052-29	TRANSISTOR 2SK2876-01MR-F122	
C499	1-126-965-91	ELECT	22 μ F 20% 50V	Q601	8-729-052-29	TRANSISTOR 2SK2876-01MR-F122	
\triangle C506	1-117-214-11	CERAMIC	0.001 μ F 10% 2KV	RESISTOR			
\triangle C507	1-117-642-11	FILM	8200pF 3% 1.2KV	R001	1-216-813-11	RES-CHIP	220 5% 1/10W
\triangle C508	1-129-722-00	FILM	0.047 μ F 5% 630V	R036	1-216-829-11	RES-CHIP	4.7K 5% 1/10W
C511	1-115-521-11	FILM	0.82 μ F 5% 250V	R079	1-216-864-11	SHORT	
C514	1-115-519-11	FILM	0.56 μ F 5% 250V	R085	1-216-864-11	SHORT	
C523	1-136-346-51	MYLAR	0.22 μ F 20% 125V	R101	1-216-832-11	RES-CHIP	8.2K 5% 1/10W
C536	1-162-964-11	CERAMIC CHIP	0.001 μ F 10% 50V	R104	1-216-864-11	SHORT	
\triangle C602	1-136-311-51	MYLAR	0.47 μ F 20% 125V	R106	1-216-864-11	SHORT	
\triangle C603	1-136-311-51	MYLAR	0.47 μ F 20% 125V	R200	1-216-841-11	RES-CHIP	47K 5% 1/10W
C621	1-165-921-11	ELECT	390 μ F 20% 250V	R203	1-216-853-11	RES-CHIP	470K 5% 1/10W
C629	1-165-921-11	ELECT	390 μ F 20% 250V	R204	1-249-437-11	CARBON	47K 5% 1/4W
C672	1-135-871-21	FILM	15000pF 3% 800V	R205	1-216-841-11	RES-CHIP	47K 5% 1/10W
DIODE				R206	1-216-853-11	RES-CHIP	470K 5% 1/10W
D001	8-719-070-80	DIODE LNK0120022G		R208	1-249-437-11	CARBON	47K 5% 1/4W
D506	8-719-979-85	DIODE RGP15GPKG23		R209	1-249-437-11	CARBON	47K 5% 1/4W
D596	8-719-908-03	DIODE GP08DPKG23		R211	1-249-437-11	CARBON	47K 5% 1/4W
D598	8-719-908-03	DIODE GP08DPKG23		R212	1-249-437-11	CARBON	47K 5% 1/4W
D612	8-719-068-00	DIODE ERC04-06SE		R220	1-216-841-11	RES-CHIP	47K 5% 1/10W
D613	8-719-068-00	DIODE ERC04-06SE		R234	1-216-864-11	SHORT	
FUSE				R250	1-216-864-11	SHORT	
\triangle F601	1-576-193-11	FUSE 6.3A/125V		R251	1-216-864-11	SHORT	
IC							
IC004	8-742-212-20	HYB, IC SBX3081-71					

VARIANT PARTS LIST





NOTE: The components identified by shading and mark are critical FOR safety. Replace ONLY with part number specified.

NOTE: Les composants identifiés par un trame et une marque sont critiques pour la securite. Ne les remplacer que par une piece portant le numero specifie.

The parts on this page belong to the following model(s) ONLY:
KV-21FM100(N)

REF. NO.	PART NO.	DESCRIPTION	VALUES			REF. NO.	PART NO.	DESCRIPTION	VALUES
R404	1-216-864-11	SHORT							
R405	1-216-864-11	SHORT							
R410	1-216-864-11	SHORT							
R413	1-216-864-11	SHORT							
R455	1-216-821-11	RES-CHIP	1K	5%	1/10W				
R456	1-216-821-11	RES-CHIP	1K	5%	1/10W				
R457	1-216-821-11	RES-CHIP	1K	5%	1/10W				
R458	1-216-821-11	RES-CHIP	1K	5%	1/10W				
R459	1-216-817-11	RES-CHIP	470	5%	1/10W				
R460	1-216-817-11	RES-CHIP	470	5%	1/10W				
R461	1-216-821-11	RES-CHIP	1K	5%	1/10W				
R462	1-216-821-11	RES-CHIP	1K	5%	1/10W				
R487	1-216-837-11	RES-CHIP	22K	5%	1/10W				
R488	1-216-837-11	RES-CHIP	22K	5%	1/10W				
R489	1-216-805-11	RES-CHIP	47	5%	1/10W				
R490	1-216-805-11	RES-CHIP	47	5%	1/10W				
R499	1-218-700-11	METAL CHIP	2.2K	0.50%	1/16W				
R503	1-215-921-11	METAL OXIDE	4.7K	5%	3W				
R510	1-260-320-11	CARBON	220	5%	1/2W				
R512	1-215-910-00	METAL OXIDE	68	5%	3W				
R513	1-215-913-11	METAL OXIDE	220	5%	3W				
R515	1-215-886-11	METAL OXIDE	100	5%	2W				
R528	1-218-867-11	RES-CHIP	6.8K	5%	1/10W				
R529	1-216-837-11	RES-CHIP	22K	5%	1/10W				
R533	1-216-826-11	RES-CHIP	2.7K	5%	1/10W				
R535	1-216-825-11	RES-CHIP	2.2K	5%	1/10W				
R536	1-216-833-11	RES-CHIP	10K	5%	1/10W				
R537	1-216-855-11	RES-CHIP	680K	5%	1/10W				
R541	1-215-449-00	METAL	15K	1%	1/4W				
R548	1-218-720-11	METAL CHIP	15K	0.50%	1/16W				
R549	1-216-837-11	RES-CHIP	22K	5%	1/10W				
R585	1-215-453-00	METAL	22K	1%	1/4W				
R594	1-249-417-11	CARBON	1K	5%	1/4W				
R601	1-205-998-11	CEMENTED	1	5%	10W				
R602	1-202-961-11	CEMENTED	1.8	5%	10W				
R603	1-219-513-11	CARBON	4.7M	5%	1/2W				
R631	1-218-716-11	METAL CHIP	10K	0.50%	1/16W				
R687	1-202-961-11	CEMENTED	1.8	5%	10W				
SWITCH									
S001	1-692-431-21	SWITCH TACTILE							
TRANSFORMER									
T511	1-435-079-11	TRANSFORMER, HORIZONTAL LINEAR							
T585	1-453-316-21	FBT ASSY NX-1748//X4A4							
T601	1-435-617-11	TRANSFORMER, LINE FILTER							
T602	1-435-675-11	TRANSFORMER, STANDBY							
T603	1-437-609-11	POWER ISOLATION TRANSFORMER							
THERMISTOR									
THP501	1-809-539-11	THERMISTOR, POSITIVE							
TUNER									
TU101	8-598-594-00	TUNER, FSS BTF-FA421							
VARISTOR									
VDR600	1-803-585-11	VARISTOR ENE271D-10A							









NOTE: The components identified by shading and  mark are critical FOR safety. Replace ONLY with part number specified.

NOTE: Les composants identifiés par un trame et une marque  sont critiques pour la sécurité. Ne les remplacer que par une pièce portant le numéro spécifié.

VARIANT PARTS LIST



The parts on this page belong to the following model(s) ONLY:
KV-21FM100(S)

REF. NO.	PART NO.	DESCRIPTION	VALUES			REF. NO.	PART NO.	DESCRIPTION	VALUES			
CAPACITOR												
C001	1-164-230-11	CERAMIC CHIP	220pF	5%	50V							
C066	1-126-947-11	ELECT	47μF	20%	25V							
C200	1-113-619-11	CERAMIC CHIP	0.47μF		10V							
C203	1-113-619-211	CERAMIC CHIP	0.47μF		10V							
C204	1-113-619-11	CERAMIC CHIP	0.47μF		10V							
						JACK						
C212	1-126-968-11	ELECT	100μF	20%	50V	J200	1-794-115-11	JACK BLOCK PIN	2P			
C213	1-126-968-11	ELECT	100μF	20%	50V	J201	1-580-441-41	JACK, PIN	2P			
C370	1-162-969-11	CERAMIC CHIP	0.0068μF	10%	25V							
C452	1-126-933-11	ELECT	100μF	20%	16V							
C454	1-164-677-11	CERAMIC CHIP	0.033μF	10%	16V							
						COIL						
C455	1-164-677-11	CERAMIC CHIP	0.033μF	10%	16V		L510	1-406-981-21	INDUCTOR	470μH		
C457	1-137-378-11	MYLAR	0.22μF	5%	50V							
C458	1-137-378-11	MYLAR	0.22μF	5%	50V							
C459	1-137-194-91	FILM	0.47μF	5%	50V							
C460	1-137-194-91	FILM	0.47μF	5%	50V							
						IC LINK						
C499	1-126-965-91	ELECT	22μF	20%	50V	PS401	1-576-336-21	LINK, IC				
	C506	1-117-214-11	CERAMIC	0.001μF	10%	2KV						
	C507	1-117-642-11	FILM	8200pF	3%	1.2KV						
	C508	1-129-722-00	FILM	0.047μF	5%	630V						
C511	1-115-521-11	FILM	0.82μF	5%	250V							
						TRANSISTOR						
C514	1-115-519-11	FILM	0.56μF	5%	250V	Q404	8-729-422-27	TRANSISTOR 2SD601A-QRS-TX				
C523	1-136-346-61	MYLAR	0.22μF	20%	300V	Q405	8-729-422-27	TRANSISTOR 2SD601A-QRS-TX				
C536	1-162-964-11	CERAMIC CHIP	0.001μF	10%	50V		Q506	6-550-042-01	TRANSISTOR 2SD2627LS-YB11			
	C602	1-136-311-61	MYLAR	0.47μF	20%	300V	Q600	8-729-052-29	TRANSISTOR 2SK2876-01MR-F122			
	C603	1-136-311-61	MYLAR	0.47μF	20%	300V	Q601	8-729-052-29	TRANSISTOR 2SK2876-01MR-F122			
C621	1-165-921-11	ELECT	390μF	20%	250V							
C629	1-165-921-11	ELECT	390μF	20%	250V							
C672	1-135-871-21	FILM	15000pF	3%	800V							
						RESISTOR						
DIODE						R001	1-216-813-11	RES-CHIP	220	5%	1/10W	
D001	8-719-070-80	DIODE LNK0120022G				R036	1-216-829-11	RES-CHIP	4.7K	5%	1/10W	
D506	8-719-979-85	DIODE RGP15GPKG23				R079	1-216-864-11	SHORT				
D596	8-719-908-03	DIODE GP08DPKG23				R085	1-216-864-11	SHORT				
D598	8-719-908-03	DIODE GP08DPKG23				R101	1-216-832-11	RES-CHIP	8.2K	5%	1/10W	
						R104	1-216-864-11	SHORT				
						R106	1-216-864-11	SHORT				
						R200	1-216-841-11	RES-CHIP	47K	5%	1/10W	
						R203	1-216-853-11	RES-CHIP	470K	5%	1/10W	
						R204	1-249-437-11	CARBON	47K	5%	1/4W	
						R205	1-216-841-11	RES-CHIP	47K	5%	1/10W	
						R206	1-216-853-11	RES-CHIP	470K	5%	1/10W	
						R208	1-249-437-11	CARBON	47K	5%	1/4W	
						R209	1-249-437-11	CARBON	47K	5%	1/4W	
						R211	1-249-437-11	CARBON	47K	5%	1/4W	
						R212	1-249-437-11	CARBON	47K	5%	1/4W	
						R220	1-216-841-11	RES-CHIP	47K	5%	1/10W	
						R234	1-216-864-11	SHORT				
						R250	1-216-864-11	SHORT				
						R251	1-216-864-11	SHORT				
						FUSE						
	F601	1-532-506-51	FUSE	6.3A/250V								
						IC						
IC004	8-742-212-20	HYB, IC SBX3081-71										
IC402	8-759-450-93	IC NJM2521M-TE1										









NOTE: The components identified by shading and  mark are critical FOR safety. Replace ONLY with part number specified.

NOTE: Les composants identifiés par un trame et une marque  sont critiques pour la sécurité. Ne les remplacer que par une pièce portant le numéro spécifié.

VARIANT PARTS LIST



The parts on this page belong to the following model(s) ONLY:
KV-21FM100(S)

REF. NO.	PART NO.	DESCRIPTION	VALUES			REF. NO.	PART NO.	DESCRIPTION	VALUES
R404	1-216-864-11	SHORT				TRANSFORMER			
R405	1-216-864-11	SHORT				 T511	1-435-079-11	TRANSFORMER, HORIZONTAL LINEAR	
R410	1-216-864-11	SHORT				 T585	1-453-316-21	FBT ASSY NX-1748//XA4A	
R413	1-216-864-11	SHORT				 T601	1-426-717-11	TRANSFORMER, LINE FILTER (LFT)	
R455	1-216-821-11	RES-CHIP	1K	5%	1/10W	 T602	1-435-676-11	TRANSFORMER, STANDBY	
R456	1-216-821-11	RES-CHIP	1K	5%	1/10W	 T603	1-437-609-11	POWER ISOLATION TRANSFORMER	
R457	1-216-821-11	RES-CHIP	1K	5%	1/10W	THERMISTOR			
R458	1-216-821-11	RES-CHIP	1K	5%	1/10W	THP501	1-803-540-11	THERMISTOR	
R459	1-216-817-11	RES-CHIP	470	5%	1/10W	TUNER			
R460	1-216-817-11	RES-CHIP	470	5%	1/10W	 TU101	8-598-594-00	TUNER, FSS BTF-FA421	
R461	1-216-821-11	RES-CHIP	1K	5%	1/10W	VARISTOR			
R462	1-216-821-11	RES-CHIP	1K	5%	1/10W	VDR600	1-803-967-11	VARISTOR (ENE621D-14A)	
R487	1-216-837-11	RES-CHIP	22K	5%	1/10W				
R488	1-216-837-11	RES-CHIP	22K	5%	1/10W				
R489	1-216-805-11	RES-CHIP	47	5%	1/10W				
R490	1-216-805-11	RES-CHIP	47	5%	1/10W				
R499	1-218-700-11	METAL CHIP	2.2K	0.50%	1/16W				
R503	1-215-921-11	METAL OXIDE	4.7K	5%	3W				
R510	1-260-320-11	CARBON	220	5%	1/2W				
R512	1-215-910-00	METAL OXIDE	68	5%	3W				
R513	1-215-913-11	METAL OXIDE	220	5%	3W				
R515	1-215-886-11	METAL OXIDE	100	5%	2W				
 R528	1-218-867-11	RES-CHIP	6.8K	5%	1/10W				
R529	1-216-837-11	RES-CHIP	22K	5%	1/10W				
R533	1-216-826-11	RES-CHIP	2.7K	5%	1/10W				
R535	1-216-825-11	RES-CHIP	2.2K	5%	1/10W				
R536	1-216-833-11	RES-CHIP	10K	5%	1/10W				
R537	1-216-855-11	RES-CHIP	680K	5%	1/10W				
R541	1-215-449-00	METAL	15K	1%	1/4W				
R548	1-218-720-11	METAL CHIP	15K	0.50%	1/16W				
R549	1-216-837-11	RES-CHIP	22K	5%	1/10W				
R585	1-215-453-00	METAL	22K	1%	1/4W				
 R594	1-249-417-11	CARBON	1K	5%	1/4W				
R601	1-244-206-11	WIREWOUND	2.2	5%	10W				
R602	1-244-206-11	WIREWOUND	2.2	5%	10W				
R631	1-218-716-11	METAL CHIP	10K	0.50%	1/16W				
R687	1-244-206-11	WIREWOUND	2.2	5%	10W				
 R699	1-218-265-11	METAL	8.2M	5%	1W				
SWITCH									
S001	1-692-431-21	SWITCH TACTILE							





NOTE: The components identified by shading and  mark are critical FOR safety. Replace ONLY with part number specified.

NOTE: Les composants identifiés par un trame et une marque  sont critiques pour la sécurité. Ne les remplacer que par une pièce portant le numéro spécifié.

VARIANT PARTS LIST



The parts on this page belong to the following model(s) ONLY:
KV-25FV300(S)

REF. NO.	PART NO.	DESCRIPTION	VALUES			REF. NO.	PART NO.	DESCRIPTION	VALUES		
CAPACITOR						C457	1-126-963-11	ELECT	4.7µF	20%	50V
C069	1-126-964-11	ELECT	10µF	20%	50V	C458	1-126-963-11	ELECT	4.7µF	20%	50V
C200	1-107-826-11	CERAMIC CHIP	0.1µF	10%	16V	C461	1-127-715-91	CERAMIC CHIP	0.22µF	10%	16V
C202	1-107-826-11	CERAMIC CHIP	0.1µF	10%	16V	C462	1-127-715-91	CERAMIC CHIP	0.22µF	10%	16V
C203	1-107-826-11	CERAMIC CHIP	0.1µF	10%	16V	C463	1-127-715-91	CERAMIC CHIP	0.22µF	10%	16V
C204	1-107-826-11	CERAMIC CHIP	0.1µF	10%	16V	C464	1-127-715-91	CERAMIC CHIP	0.22µF	10%	16V
C205	1-107-826-11	CERAMIC CHIP	0.1µF	10%	16V	C499	1-126-963-11	ELECT	4.7µF	20%	50V
C206	1-126-963-11	ELECT	4.7µF	20%	50V	C500	1-165-176-11	CERAMIC CHIP	0.047µF	10%	16V
C207	1-126-963-11	ELECT	4.7µF	20%	50V	 C506	1-162-116-00	CERAMIC	680pF	10%	2KV
C212	1-126-963-11	ELECT	4.7µF	20%	50V	 C507	1-127-717-21	FILM	19000pF	3%	1.2KV
C213	1-126-963-11	ELECT	4.7µF	20%	50V	 C508	1-130-895-00	FILM	0.056µF	10%	400V
C220	1-107-826-11	CERAMIC CHIP	0.1µF	10%	16V	C511	1-117-813-11	FILM	0.75µF	5%	250V
C301	1-126-956-91	ELECT	0.1µF	20%	50V	C514	1-115-521-11	FILM	0.82µF	5%	250V
C302	1-126-956-91	ELECT	0.1µF	20%	50V	C516	1-117-661-11	FILM	0.15µF	5%	250V
C305	1-107-826-11	CERAMIC CHIP	0.1µF	10%	16V	C523	1-136-346-61	MYLAR	0.22µF	20%	300V
C306	1-107-826-11	CERAMIC CHIP	0.1µF	10%	16V	C535	1-137-372-11	MYLAR	0.022µF	5%	50V
C307	1-107-826-11	CERAMIC CHIP	0.1µF	10%	16V	 C602	1-136-311-61	MYLAR	0.47µF	20%	300V
C360	1-164-230-11	CERAMIC CHIP	220pF	5%	50V	 C603	1-136-311-61	MYLAR	0.47µF	20%	300V
C361	1-164-230-11	CERAMIC CHIP	220pF	5%	50V	C536	1-162-966-11	CERAMIC CHIP	0.0022µF	10%	50V
C362	1-162-964-11	CERAMIC CHIP	0.001µF	10%	50V	C621	1-165-922-11	ELECT	470µF	20%	250V
C363	1-162-964-11	CERAMIC CHIP	0.001µF	10%	50V	C629	1-165-922-11	ELECT	470µF	20%	250V
C370	1-162-970-11	CERAMIC CHIP	0.01µF	10%	25V	C672	1-137-756-21	FILM	22000pF	3%	800V
C400	1-128-934-91	CERAMIC CHIP	0.33µF	20%	10V	CONNECTOR					
C401	1-164-227-11	CERAMIC CHIP	0.022µF	10%	25V	CN002	1-564-509-11	PLUG,CONNECTOR	6P		
C402	1-164-174-11	CERAMIC CHIP	0.0082µF	10%	25V	DIODE					
C403	1-162-967-11	CERAMIC CHIP	0.0033µF	10%	50V	D200	8-719-929-15	DIODE MTZJ-T-77-9.1B			
C404	1-162-967-11	CERAMIC CHIP	0.0033µF	10%	50V	D203	8-719-929-15	DIODE MTZJ-T-77-9.1B			
C405	1-164-677-11	CERAMIC CHIP	0.033µF	10%	16V	D204	8-719-929-15	DIODE MTZJ-T-77-9.1B			
C406	1-164-677-11	CERAMIC CHIP	0.033µF	10%	16V	D205	8-719-929-15	DIODE MTZJ-T-77-9.1B			
C407	1-162-965-11	CERAMIC CHIP	0.0015µF	10%	50V	D206	8-719-929-15	DIODE MTZJ-T-77-9.1B			
C408	1-162-965-11	CERAMIC CHIP	0.0015µF	10%	50V	D208	8-719-929-15	DIODE MTZJ-T-77-9.1B			
C409	1-127-715-91	CERAMIC CHIP	0.22µF	10%	16V	D231	8-719-108-12	DIODE RD9.1EW-T1			
C410	1-127-715-91	CERAMIC CHIP	0.22µF	10%	16V	D234	8-719-108-12	DIODE RD9.1EW-T1			
C411	1-128-934-91	CERAMIC CHIP	0.33µF	20%	10V	D235	8-719-108-12	DIODE RD9.1EW-T1			
C412	1-126-960-11	ELECT	1µF	20%	50V	D236	8-719-108-12	DIODE RD9.1EW-T1			
C413	1-126-960-11	ELECT	1µF	20%	50V	D237	8-719-108-12	DIODE RD9.1EW-T1			
C414	1-126-961-11	ELECT	2.2µF	20%	50V	D506	8-719-312-10	DIODE RU4AM-T3			
C415	1-126-960-11	ELECT	1µF	20%	50V	D596	8-719-979-85	DIODE RGP15GPKG23			
C416	1-126-960-11	ELECT	1µF	20%	50V	D598	8-719-979-85	DIODE RGP15GPKG23			
C418	1-126-963-11	ELECT	4.7µF	20%	50V						
C420	1-126-960-11	ELECT	1µF	20%	50V						
C422	1-126-960-11	ELECT	1µF	20%	50V						
C452	1-126-967-11	ELECT	47µF	20%	50V						

VARIANT PARTS LIST



NOTE: The components identified by shading and mark are critical FOR safety. Replace ONLY with part number specified.

NOTE: Les composants identifiés par un trame et une marque sont critiques pour la sécurité. Ne les remplacer que par une pièce portant le numéro spécifié.

The parts on this page belong to the following model(s) ONLY:
KV-25FV300(S)

REF. NO.	PART NO.	DESCRIPTION	VALUES	REF. NO.	PART NO.	DESCRIPTION	VALUES
FUSE				R206	1-216-845-11	RES-CHIP	100K 5% 1/10W
	F601	1-532-506-51	FUSE 6.3A/250V	R207	1-216-845-11	RES-CHIP	100K 5% 1/10W
IC				R208	1-249-409-11	CARBON	220 5% 1/4W
IC005	8-759-353-00	IC NJM2534M(TE2)		R209	1-249-409-11	CARBON	220 5% 1/4W
IC400	6-701-106-01	IC NJW1134G-TE2		R210	1-216-845-11	RES-CHIP	100K 5% 1/10W
IC404	6-701-107-01	IC AN7125Z		R211	1-249-409-11	CARBON	220 5% 1/4W
IC545	8-759-980-58	IC TDA8172		R212	1-249-409-11	CARBON	220 5% 1/4W
JACK				R213	1-216-845-11	RES-CHIP	100K 5% 1/10W
J200	1-794-119-11	TERMINAL BLOCK S	4P	R215	1-216-845-11	RES-CHIP	100K 5% 1/10W
J201	1-794-048-11	JACK, PIN	3P	R216	1-216-845-11	RES-CHIP	100K 5% 1/10W
J202	1-794-116-11	JACK BLOCK PIN	2P	R217	1-249-409-11	CARBON	220 5% 1/4W
J205	1-794-116-11	JACK BLOCK PIN	2P	R218	1-249-409-11	CARBON	220 5% 1/4W
J206	1-794-117-11	JACK BLOCK PIN	3P	R220	1-216-813-11	RES-CHIP	220 5% 1/10W
COIL				R221	1-249-409-11	CARBON	220 5% 1/4W
L360	1-412-029-11	INDUCTOR	10µH	R222	1-249-409-11	CARBON	220 5% 1/4W
L361	1-412-029-11	INDUCTOR	10µH	R227	1-218-285-11	RES-CHIP	75 5% 1/10W
L516	1-406-978-11	INDUCTOR	150µH	R250	1-216-837-11	RES-CHIP	22K 5% 1/10W
IC LINK				R251	1-216-837-11	RES-CHIP	22K 5% 1/10W
PS401	1-576-337-21	LINK, IC		R301	1-218-285-11	RES-CHIP	75 5% 1/10W
TRANSISTOR				R305	1-218-285-11	RES-CHIP	75 5% 1/10W
	Q505	6-550-041-01	TRANSISTOR 2SD2634-YB	R306	1-218-285-11	RES-CHIP	75 5% 1/10W
Q600	8-729-053-36	TRANSISTOR 2SK2640-01MR-F122		R307	1-218-285-11	RES-CHIP	75 5% 1/10W
Q601	8-729-053-36	TRANSISTOR 2SK2640-01MR-F122		R360	1-216-809-11	RES-CHIP	100 5% 1/10W
RESISTOR				R361	1-216-809-11	RES-CHIP	100 5% 1/10W
R029	1-249-409-11	CARBON	220 5% 1/4W	R400	1-216-829-11	RES-CHIP	4.7K 5% 1/10W
R030	1-249-409-11	CARBON	220 5% 1/4W	R401	1-216-809-11	RES-CHIP	100 5% 1/10W
R032	1-216-813-11	RES-CHIP	220 5% 1/10W	R403	1-216-809-11	RES-CHIP	100 5% 1/10W
R036	1-216-825-11	RES-CHIP	2.2K 5% 1/10W	R427	1-216-829-11	RES-CHIP	4.7K 5% 1/10W
R046	1-249-409-11	CARBON	220 5% 1/4W	R429	1-216-829-11	RES-CHIP	4.7K 5% 1/10W
R060	1-249-409-11	CARBON	220 5% 1/4W	R431	1-216-789-11	RES-CHIP	2.2 5% 1/10W
R101	1-216-829-11	RES-CHIP	4.7K 5% 1/10W	R432	1-216-789-11	RES-CHIP	2.2 5% 1/10W
R105	1-216-864-11	SHORT		R433	1-216-789-11	RES-CHIP	2.2 5% 1/10W
R109	1-216-829-11	RES-CHIP	4.7K 5% 1/10W	R434	1-216-789-11	RES-CHIP	2.2 5% 1/10W
R111	1-216-829-11	RES-CHIP	4.7K 5% 1/10W	R461	1-216-845-11	RES-CHIP	100K 5% 1/10W
R200	1-216-813-11	RES-CHIP	220 5% 1/10W	R462	1-216-845-11	RES-CHIP	100K 5% 1/10W
R202	1-216-845-11	RES-CHIP	100K 5% 1/10W	R482	1-216-864-11	SHORT	
R203	1-216-845-11	RES-CHIP	100K 5% 1/10W	R499	1-216-833-11	RES-CHIP	10K 5% 1/10W
R204	1-249-409-11	CARBON	220 5% 1/4W	R503	1-215-919-11	METAL OXIDE	2.2K 5% 3W
				R510	1-260-328-11	CARBON	1K 5% 1/2W
				R513	1-215-908-00	METAL OXIDE	33 5% 3W
				R515	1-215-885-00	METAL OXIDE	68 5% 2W
					R528	1-216-816-11	RES-CHIP 390 5% 1/10W
				R529	1-216-835-11	RES-CHIP	15K 5% 1/10W
				R533	1-216-833-11	RES-CHIP	10K 5% 1/10W











VARIANT PARTS LIST



NOTE: The components identified by shading and  mark are critical FOR safety. Replace ONLY with part number specified.

NOTE: Les composants identifiés par un trame et une marque  sont critiques pour la securite. Ne les remplacer que par une piece portant le numero specifie.

The parts on this page belong to the following model(s) ONLY:
KV-25FV300(S)

REF. NO.	PART NO.	DESCRIPTION	VALUES			REF. NO.	PART NO.	DESCRIPTION	VALUES		
R535	1-216-830-11	RES-CHIP	5.6K	5%	1/10W						
R536	1-218-867-11	RES-CHIP	6.8K	5%	1/10W						
R537	1-216-842-11	RES-CHIP	56K	5%	1/10W						
R538	1-216-811-11	RES-CHIP	150	5%	1/10W						
R541	1-215-443-00	METAL	8.2K	1%	1/4W						
R548	1-218-714-11	METAL CHIP	8.2K	0.50%	1/16W						
R549	1-216-833-11	RES-CHIP	10K	5%	1/10W						
R552	1-216-857-11	RES-CHIP	1M	5%	1/10W						
 R564	1-218-738-11	METAL CHIP	82K	0.50%	1/16W						
R585	1-215-447-00	METAL	12K	1%	1/4W						
 R594	1-249-418-11	CARBON	1.2K	5%	1/4W						
R601	1-244-206-11	WIREWOUND	2.2	5%	10W						
R602	1-244-206-11	WIREWOUND	2.2	5%	10W						
R631	1-218-718-11	METAL CHIP	12K	0.50%	1/16W						
R687	1-244-206-11	WIREWOUND	2.2	5%	10W						
 R699	1-218-265-11	METAL	8.2M	5%	1W						
R852	1-216-844-11	RES-CHIP	82K	5%	1/10W						
<u>TRANSFORMER</u>											
 T510	1-437-610-11	TRANSFORMER, FERRITE (PMT)									
 T511	1-433-850-11	TRANSFORMER, HORIZONTAL LINEAR									
 T585	1-453-336-11	FBT ASSY NX-4011//X4A4									
 T601	1-426-717-11	TRANSFORMER, LINE FILTER (LFT)									
 T602	1-435-676-11	TRANSFORMER, STANDBY									
 T603	1-437-611-11	POWER ISOLATION TRANSFORMER									
<u>THERMISTOR</u>											
THP501	1-803-540-11	THERMISTOR									
<u>TUNER</u>											
 TU101	8-598-593-00	TUNER, FSS BTF-WA421									
<u>VARISTOR</u>											
VDR600	1-803-967-11	VARISTOR (ENE621D-14A)									

NOTE: The components identified by shading and \triangle mark are critical FOR safety. Replace ONLY with part number specified.

NOTE: Les composants identifiés par un trame et une marque \triangle sont critiques pour la sécurité. Ne les remplacer que par une pièce portant le numéro spécifié.

VARIANT PARTS LIST



The parts on this page belong to the following model(s) ONLY:
KV-24FV300/25FV300(N)

REF. NO.	PART NO.	DESCRIPTION	VALUES			REF. NO.	PART NO.	DESCRIPTION	VALUES		
CAPACITOR						C457	1-126-963-11	ELECT	4.7 μ F	20%	50V
C069	1-126-964-11	ELECT	10 μ F	20%	50V	C458	1-126-963-11	ELECT	4.7 μ F	20%	50V
C200	1-107-826-11	CERAMIC CHIP	0.1 μ F	10%	16V	C461	1-127-715-91	CERAMIC CHIP	0.22 μ F	10%	16V
C202	1-107-826-11	CERAMIC CHIP	0.1 μ F	10%	16V	C462	1-127-715-91	CERAMIC CHIP	0.22 μ F	10%	16V
C203	1-107-826-11	CERAMIC CHIP	0.1 μ F	10%	16V	C463	1-127-715-91	CERAMIC CHIP	0.22 μ F	10%	16V
C204	1-107-826-11	CERAMIC CHIP	0.1 μ F	10%	16V	C464	1-127-715-91	CERAMIC CHIP	0.22 μ F	10%	16V
C205	1-107-826-11	CERAMIC CHIP	0.1 μ F	10%	16V	C499	1-126-963-11	ELECT	4.7 μ F	20%	50V
C206	1-126-963-11	ELECT	4.7 μ F	20%	50V	C500	1-165-176-11	CERAMIC CHIP	0.047 μ F	10%	16V
C207	1-126-963-11	ELECT	4.7 μ F	20%	50V	\triangle C506	1-162-116-00	CERAMIC	680pF	10%	2KV
C212	1-126-963-11	ELECT	4.7 μ F	20%	50V	\triangle C507	1-127-717-21	FILM	19000pF	3%	1.2KV
C213	1-126-963-11	ELECT	4.7 μ F	20%	50V	\triangle C508	1-130-895-00	FILM	0.056 μ F	10%	400V
C220	1-107-826-11	CERAMIC CHIP	0.1 μ F	10%	16V	C511	1-117-813-11	FILM	0.75 μ F	5%	250V
C301	1-126-956-91	ELECT	0.1 μ F	20%	50V	C514	1-115-521-11	FILM	0.82 μ F	5%	250V
C302	1-126-956-91	ELECT	0.1 μ F	20%	50V	C516	1-117-661-11	FILM	0.15 μ F	5%	250V
C305	1-107-826-11	CERAMIC CHIP	0.1 μ F	10%	16V	C523	1-136-346-51	MYLAR	0.22 μ F	20%	125V
C306	1-107-826-11	CERAMIC CHIP	0.1 μ F	10%	16V	C535	1-137-372-11	MYLAR	0.022 μ F	5%	50V
C307	1-107-826-11	CERAMIC CHIP	0.1 μ F	10%	16V	C536	1-162-966-11	CERAMIC CHIP	0.0022 μ F	10%	50V
C360	1-164-230-11	CERAMIC CHIP	220pF	5%	50V	\triangle C602	1-136-311-51	MYLAR	0.47 μ F	20%	125V
C361	1-164-230-11	CERAMIC CHIP	220pF	5%	50V	\triangle C603	1-136-311-51	MYLAR	0.47 μ F	20%	125V
C362	1-162-964-11	CERAMIC CHIP	0.001 μ F	10%	50V	C621	1-165-922-11	ELECT	470 μ F	20%	250V
C363	1-162-964-11	CERAMIC CHIP	0.001 μ F	10%	50V	C629	1-165-922-11	ELECT	470 μ F	20%	250V
C370	1-162-970-11	CERAMIC CHIP	0.01 μ F	10%	25V	C672	1-137-756-21	FILM	22000pF	3%	800V
C400	1-128-934-91	CERAMIC CHIP	0.33 μ F	20%	10V	CONNECTOR					
C401	1-164-227-11	CERAMIC CHIP	0.022 μ F	10%	25V	CN002	1-564-509-11	PLUG,CONNECTOR	6P		
C402	1-164-174-11	CERAMIC CHIP	0.0082 μ F	10%	25V	DIODE					
C403	1-162-967-11	CERAMIC CHIP	0.0033 μ F	10%	50V	D200	8-719-929-15	DIODE MTZJ-T-77-9.1B			
C404	1-162-967-11	CERAMIC CHIP	0.0033 μ F	10%	50V	D203	8-719-929-15	DIODE MTZJ-T-77-9.1B			
C405	1-164-677-11	CERAMIC CHIP	0.033 μ F	10%	16V	D204	8-719-929-15	DIODE MTZJ-T-77-9.1B			
C406	1-164-677-11	CERAMIC CHIP	0.033 μ F	10%	16V	D205	8-719-929-15	DIODE MTZJ-T-77-9.1B			
C407	1-162-965-11	CERAMIC CHIP	0.0015 μ F	10%	50V	D206	8-719-929-15	DIODE MTZJ-T-77-9.1B			
C408	1-162-965-11	CERAMIC CHIP	0.0015 μ F	10%	50V	D208	8-719-929-15	DIODE MTZJ-T-77-9.1B			
C409	1-127-715-91	CERAMIC CHIP	0.22 μ F	10%	16V	D231	8-719-108-12	DIODE RD9.1EW-T1			
C410	1-127-715-91	CERAMIC CHIP	0.22 μ F	10%	16V	D234	8-719-108-12	DIODE RD9.1EW-T1			
C411	1-128-934-91	CERAMIC CHIP	0.33 μ F	20%	10V	D235	8-719-108-12	DIODE RD9.1EW-T1			
C412	1-126-960-11	ELECT	1 μ F	20%	50V	D236	8-719-108-12	DIODE RD9.1EW-T1			
C413	1-126-960-11	ELECT	1 μ F	20%	50V	D237	8-719-108-12	DIODE RD9.1EW-T1			
C414	1-126-961-11	ELECT	2.2 μ F	20%	50V	D506	8-719-312-10	DIODE RU4AM-T3			
C415	1-126-960-11	ELECT	1 μ F	20%	50V	D596	8-719-979-85	DIODE RGP15GPKG23			
C416	1-126-960-11	ELECT	1 μ F	20%	50V	D598	8-719-979-85	DIODE RGP15GPKG23			
C418	1-126-963-11	ELECT	4.7 μ F	20%	50V	D612	8-719-068-00	DIODE ERC04-06SE			
C420	1-126-960-11	ELECT	1 μ F	20%	50V	D613	8-719-068-00	DIODE ERC04-06SE			
C422	1-126-960-11	ELECT	1 μ F	20%	50V						
C452	1-126-967-11	ELECT	47 μ F	20%	50V						



NOTE: The components identified by shading and  mark are critical FOR safety. Replace ONLY with part number specified.

NOTE: Les composants identifiés par un trame et une marque  sont critiques pour la sécurité. Ne les remplacer que par une pièce portant le numéro spécifié.

VARIANT PARTS LIST



The parts on this page belong to the following model(s) ONLY:
KV-24FV300/25FV300(N)

REF. NO.	PART NO.	DESCRIPTION	VALUES	REF. NO.	PART NO.	DESCRIPTION	VALUES
FUSE				R206	1-216-845-11	RES-CHIP	100K 5% 1/10W
	F601	1-576-193-11	FUSE 6.3A/125V	R207	1-216-845-11	RES-CHIP	100K 5% 1/10W
IC				R208	1-249-409-11	CARBON	220 5% 1/4W
IC005	8-759-353-00	IC NJM2534M(TE2)		R209	1-249-409-11	CARBON	220 5% 1/4W
IC400	6-701-106-01	IC NJW1134G-TE2		R210	1-216-845-11	RES-CHIP	100K 5% 1/10W
IC404	6-701-107-01	IC AN7125Z		R211	1-249-409-11	CARBON	220 5% 1/4W
IC545	8-759-980-58	IC TDA8172		R212	1-249-409-11	CARBON	220 5% 1/4W
JACK				R213	1-216-845-11	RES-CHIP	100K 5% 1/10W
J200	1-794-119-11	TERMINAL BLOCK S	4P	R215	1-216-845-11	RES-CHIP	100K 5% 1/10W
J201	1-794-048-11	JACK, PIN	3P	R216	1-216-845-11	RES-CHIP	100K 5% 1/10W
J202	1-794-116-11	JACK BLOCK PIN	2P	R217	1-249-409-11	CARBON	220 5% 1/4W
J205	1-794-116-11	JACK BLOCK PIN	2P	R218	1-249-409-11	CARBON	220 5% 1/4W
J206	1-794-117-11	JACK BLOCK PIN	3P	R220	1-216-813-11	RES-CHIP	220 5% 1/10W
COIL				R221	1-249-409-11	CARBON	220 5% 1/4W
L360	1-412-029-11	INDUCTOR	10µH	R222	1-249-409-11	CARBON	220 5% 1/4W
L361	1-412-029-11	INDUCTOR	10µH	R227	1-218-285-11	RES-CHIP	75 5% 1/10W
L516	1-406-978-11	INDUCTOR	150µH	R250	1-216-837-11	RES-CHIP	22K 5% 1/10W
IC LINK				R251	1-216-837-11	RES-CHIP	22K 5% 1/10W
PS401	1-576-337-21	LINK, IC		R301	1-218-285-11	RES-CHIP	75 5% 1/10W
TRANSISTOR				R305	1-218-285-11	RES-CHIP	75 5% 1/10W
	Q505	6-550-041-01	TRANSISTOR 2SD2634-YB	R306	1-218-285-11	RES-CHIP	75 5% 1/10W
Q600	8-729-053-36	TRANSISTOR 2SK2640-01MR-F122		R307	1-218-285-11	RES-CHIP	75 5% 1/10W
Q601	8-729-053-36	TRANSISTOR 2SK2640-01MR-F122		R360	1-216-809-11	RES-CHIP	100 5% 1/10W
RESISTOR				R361	1-216-809-11	RES-CHIP	100 5% 1/10W
R029	1-249-409-11	CARBON	220 5% 1/4W	R400	1-216-829-11	RES-CHIP	4.7K 5% 1/10W
R030	1-249-409-11	CARBON	220 5% 1/4W	R401	1-216-809-11	RES-CHIP	100 5% 1/10W
R032	1-216-813-11	RES-CHIP	220 5% 1/10W	R403	1-216-809-11	RES-CHIP	100 5% 1/10W
R036	1-216-825-11	RES-CHIP	2.2K 5% 1/10W	R427	1-216-829-11	RES-CHIP	4.7K 5% 1/10W
R046	1-249-409-11	CARBON	220 5% 1/4W	R429	1-216-829-11	RES-CHIP	4.7K 5% 1/10W
R060	1-249-409-11	CARBON	220 5% 1/4W	R431	1-216-789-11	RES-CHIP	2.2 5% 1/10W
R101	1-216-829-11	RES-CHIP	4.7K 5% 1/10W	R432	1-216-789-11	RES-CHIP	2.2 5% 1/10W
R105	1-216-864-11	SHORT		R433	1-216-789-11	RES-CHIP	2.2 5% 1/10W
R109	1-216-829-11	RES-CHIP	4.7K 5% 1/10W	R434	1-216-789-11	RES-CHIP	2.2 5% 1/10W
R111	1-216-829-11	RES-CHIP	4.7K 5% 1/10W	R461	1-216-845-11	RES-CHIP	100K 5% 1/10W
R200	1-216-813-11	RES-CHIP	220 5% 1/10W	R462	1-216-845-11	RES-CHIP	100K 5% 1/10W
R202	1-216-845-11	RES-CHIP	100K 5% 1/10W	R482	1-216-864-11	SHORT	
R203	1-216-845-11	RES-CHIP	100K 5% 1/10W	R499	1-216-833-11	RES-CHIP	10K 5% 1/10W
R204	1-249-409-11	CARBON	220 5% 1/4W	R503	1-215-919-11	METAL OXIDE	2.2K 5% 3W
				R510	1-260-328-11	CARBON	1K 5% 1/2W
				R513	1-215-908-00	METAL OXIDE	33 5% 3W
				R515	1-215-885-00	METAL OXIDE	68 5% 2W
					R528	1-216-816-11	RES-CHIP 390 5% 1/10W
				R529	1-216-835-11	RES-CHIP	15K 5% 1/10W
				R533	1-216-833-11	RES-CHIP	10K 5% 1/10W

NOTE: The components identified by shading and  mark are critical FOR safety. Replace ONLY with part number specified.









NOTE: Les composants identifiés par un trame et une marque  sont critiques pour la securite. Ne les remplacer que par une piece portant le numero specifie.

VARIANT PARTS LIST



The parts on this page belong to the following model(s) ONLY:

KV-24FV300/25FV300(N)

REF. NO.	PART NO.	DESCRIPTION	VALUES			REF. NO.	PART NO.	DESCRIPTION	VALUES		
R535	1-216-830-11	RES-CHIP	5.6K	5%	1/10W						
R536	1-218-867-11	RES-CHIP	6.8K	5%	1/10W						
R537	1-216-842-11	RES-CHIP	56K	5%	1/10W						
R538	1-216-811-11	RES-CHIP	150	5%	1/10W						
R541	1-215-443-00	METAL	8.2K	1%	1/4W						
R548	1-218-714-11	METAL CHIP	8.2K	0.50%	1/16W						
R549	1-216-833-11	RES-CHIP	10K	5%	1/10W						
R552	1-216-857-11	RES-CHIP	1M	5%	1/10W						
 R564	1-218-738-11	METAL CHIP	82K	0.50%	1/16W						
R585	1-215-447-00	METAL	12K	1%	1/4W						
 R594	1-249-418-11	CARBON	1.2K	5%	1/4W						
R601	1-240-262-11	CEMENTED	0.68	5%	10W						
R602	1-202-961-11	CEMENTED	1.8	5%	10W						
R603	1-219-513-11	CARBON	4.7M	5%	1/2W						
R631	1-218-718-11	METAL CHIP	12K	0.50%	1/16W						
R687	1-202-961-11	CEMENTED	1.8	5%	10W						
R852	1-216-844-11	RES-CHIP	82K	5%	1/10W						
TRANSFORMER											
 T510	1-437-610-11	TRANSFORMER, FERRITE (PMT)									
 T511	1-433-850-11	TRANSFORMER, HORIZONTAL LINEAR									
 T585	1-453-336-11	FBT ASSY NX-4011//X4A4									
 T601	1-435-617-11	TRANSFORMER, LINE FILTER									
 T602	1-435-675-11	TRANSFORMER, STANDBY									
 T603	1-437-611-11	POWER ISOLATION TRANSFORMER									
THERMISTOR											
THP501	1-809-539-11	THERMISTOR, POSITIVE									
TUNER											
 TU101	8-598-593-00	TUNER, FSS BTF-WA421									
VARISTOR											
VDR600	1-803-585-11	VARISTOR ENE271D-10A									



REF. NO.	PART NO.	DESCRIPTION	VALUES			REF. NO.	PART NO.	DESCRIPTION	VALUES		
<div style="border: 1px solid black; display: inline-block; padding: 5px; font-size: 2em; font-weight: bold;">CV</div>						CN1753	1-785-879-11	CONNECTOR, ONE TOUCH			
*						CN1755	1-695-915-11	TAB (CONTACT)			
A-1400-223-A CV (VAR) BOARD, MOUNTED (FOR 21FS100/21FM100/21FV300/20FV300/20FS100 ONLY)						DIODE					
*						D762	8-719-404-50	DIODE MA111-TX			
A-1400-341-A CV (VAR) BOARD, MOUNTED (FOR 24FV300/25FV300 ONLY)						D763	8-719-404-50	DIODE MA111-TX			
4-382-854-11						D772	8-719-404-50	DIODE MA111-TX			
SCREW (M3X10), P, SW (+)						D773	8-719-404-50	DIODE MA111-TX			
CAPACITOR						D782	8-719-404-50	DIODE MA111-TX			
C780	1-162-926-11	CERAMIC CHIP	82pF	5%	50V	D783	8-719-404-50	DIODE MA111-TX			
C781	1-162-926-11	CERAMIC CHIP	82pF	5%	50V	D901	8-719-110-86	DIODE MTZJ-T-77-39			
C782	1-162-926-11	CERAMIC CHIP	82pF	5%	50V	D902	8-719-110-86	DIODE MTZJ-T-77-39			
C901	1-107-667-11	ELECT	2.2μF	20%	160V	D903	8-719-991-33	DIODE 1SS133T-77			
C902	1-130-491-00	MYLAR	0.047μF	5%	50V	D1754	8-719-901-83	DIODE 1SS83TD			
C903	1-126-935-11	ELECT	470μF	20%	16V	D1755	8-719-901-83	DIODE 1SS83TD			
C904	1-130-471-00	MYLAR	0.001μF	5%	50V	D1756	8-719-901-83	DIODE 1SS83TD			
C905	1-106-383-00	MYLAR	0.047μF	10%	200V	D1758	8-719-302-43	DIODE RGP10GPKG23			
C906	1-130-471-00	MYLAR	0.001μF	5%	50V	IC					
C907	1-107-638-11	ELECT	33μF	20%	160V	IC1707	8-759-356-16	IC NJM4556AD			
C908	1-126-935-11	ELECT	470μF	20%	16V	IC1751	8-759-562-43	IC TDA6108JF/N1B			
C909	1-161-830-00	CERAMIC	00.0047μF		500V	COIL					
C910	1-104-999-11	MYLAR	0.1μF	10%	200V	L710	1-410-387-11	INDUCTOR	33μH		
C911	1-104-665-11	ELECT	100μF	20%	25V	L711	1-410-387-11	INDUCTOR	33μH		
C912	1-126-935-11	ELECT	470μF	20%	16V	L712	1-410-387-11	INDUCTOR	33μH		
C914	1-130-491-00	MYLAR	0.047μF	5%	50V	L901	1-408-615-31	INDUCTOR	100μH		
C915	1-162-970-11	CERAMIC CHIP	0.01μF	10%	25V	L1751	1-408-613-31	INDUCTOR	68μH		
C1751	1-107-652-11	ELECT	10μF	20%	250V	TRANSISTOR					
C1752	1-162-114-00	CERAMIC	00.0047μF		2KV	Q761	8-729-422-27	TRANSISTOR 2SD601A-QRS-TX			
C1753	1-137-528-11	MYLAR	0.1μF	10%	250V	Q762	8-729-422-27	TRANSISTOR 2SD601A-QRS-TX			
C1754	1-102-074-00	CERAMIC	0.001μF	10%	50V	Q763	8-729-422-27	TRANSISTOR 2SD601A-QRS-TX			
C1755	1-107-649-11	ELECT	2.2μF	20%	250V	Q771	8-729-422-27	TRANSISTOR 2SD601A-QRS-TX			
C1774	1-126-947-11	ELECT	47μF	20%	25V	Q772	8-729-422-27	TRANSISTOR 2SD601A-QRS-TX			
C1775	1-126-935-11	ELECT	470μF	20%	16V	Q773	8-729-422-27	TRANSISTOR 2SD601A-QRS-TX			
C1777	1-126-963-11	ELECT	4.7μF	20%	50V	Q781	8-729-422-27	TRANSISTOR 2SD601A-QRS-TX			
C1778	1-126-947-11	ELECT	47μF	20%	25V	Q782	8-729-422-27	TRANSISTOR 2SD601A-QRS-TX			
(FOR 24FV300/25FV300 ONLY)						Q783	8-729-422-27	TRANSISTOR 2SD601A-QRS-TX			
CONNECTOR						Q901	8-729-045-04	TRANSISTOR 2SC5511			
CN903	1-564-506-11	PLUG,CONNECTOR	3P			Q902	8-729-045-05	TRANSISTOR 2SA2005			
CN1707	1-564-506-11	PLUG,CONNECTOR	3P			Q903	8-729-422-27	TRANSISTOR 2SD601A-QRS-TX			
CN1751	1-564-509-11	PLUG,CONNECTOR	6P			Q904	8-729-422-27	TRANSISTOR 2SD601A-QRS-TX			
* CN1752	1-564-512-11	PLUG,CONNECTOR	9P			Q905	8-729-424-02	TRANSISTOR 2SB709A-QRS-TX			



REF. NO.	PART NO.	DESCRIPTION	VALUES	REF. NO.	PART NO.	DESCRIPTION	VALUES
<div style="border: 1px solid black; padding: 5px; display: inline-block; font-weight: bold; font-size: 2em;">HR</div> <p>* A-1400-251-A HR (COM) BOARD, MOUNTED (FOR 21FV300/20FV300/24FV300/25FV300 ONLY)</p> <p>CAPACITOR</p> <p>C3001 1-104-665-11 ELECT 100µF 20% 25V</p> <p>CONNECTOR</p> <p>CN3001 1-564-521-11 PLUG,CONNECTOR 6P</p> <p>DIODE</p> <p>D3002 8-719-057-09 DIODE LNJ801LPDJA</p> <p>IC</p> <p>IC3001 8-742-211-20 HYB IC SBX3071-71</p> <p>RESISTOR</p> <p>R3001 1-249-417-11 CARBON 1K 5% 1/4W R3014 1-247-807-31 CARBON 100 5% 1/4W</p> <p>SWITCH</p> <p>S3006 1-572-198-11 SWITCH KEYBOARD</p>				<p>CONNECTOR</p> <p>CN10 1-816-567-11 HEADER,CONNECTOR 6P</p> <p>DIODE</p> <p>D50 8-719-404-50 DIODE MA111-TX</p> <p>IC</p> <p>IC1 8-759-700-07 IC NJM2903M-TE2 IC2 8-759-700-07 IC NJM2903M-TE2 IC3 8-759-701-01 IC NJM2904M(TE2)</p> <p>CHIP CONDUCTOR</p> <p>JR1 1-216-864-11 SHORT JR2 1-216-864-11 SHORT JR6 1-216-864-11 SHORT JR7 1-216-864-11 SHORT JR12 1-216-864-11 SHORT JR44 1-216-864-11 SHORT</p> <p>COIL</p> <p>L50 1-408-615-31 INDUCTOR 100µH</p> <p>TRANSISTOR</p> <p>Q50 8-729-422-27 TRANSISTOR 2SD601A-QRS-TX Q51 8-729-422-27 TRANSISTOR 2SD601A-QRS-TX Q52 8-729-422-27 TRANSISTOR 2SD601A-QRS-TX</p> <p>RESISTOR</p> <p>R10 1-208-798-11 METAL CHIP 4.7K 0.50% 1/10W R11 1-208-798-11 METAL CHIP 4.7K 0.50% 1/10W R12 1-218-692-11 METAL CHIP 1K 0.50% 1/16W R13 1-208-798-11 METAL CHIP 4.7K 0.50% 1/10W R50 1-216-829-11 RES-CHIP 4.7K 5% 1/10W R51 1-216-833-11 RES-CHIP 10K 5% 1/10W R52 1-216-833-11 RES-CHIP 10K 5% 1/10W R53 1-216-829-11 RES-CHIP 4.7K 5% 1/10W R54 1-216-829-11 RES-CHIP 4.7K 5% 1/10W R55 1-216-065-91 RES-CHIP 4.7K 5% 1/10W R56 1-216-823-11 RES-CHIP 1.5K 5% 1/10W R70 1-218-716-11 METAL CHIP 10K 0.50% 1/16W R71 1-218-716-11 METAL CHIP 10K 0.50% 1/16W R57 1-216-864-11 SHORT R58 1-216-835-11 RES-CHIP 15K 5% 1/10W</p>			
				<div style="border: 1px solid black; padding: 5px; display: inline-block; font-weight: bold; font-size: 2em;">M3</div> <p>* A-1400-738-A M3 (VAR) BOARD, MOUNTED (FOR 20FS100/21FM100/21FV300/20FV300/21FS100 ONLY)</p> <p>* A-1400-739-A M3 (VAR) BOARD, MOUNTED (FOR 24FV300/25FV300 ONLY)</p> <p>CAPACITOR</p> <p>C10 1-126-947-11 ELECT 47µF 20% 25V C11 1-162-970-11 CERAMIC CHIP 0.01µF 10% 25V C12 1-163-275-11 CERAMIC CHIP 0.001µF 5% 50V C13 1-162-970-11 CERAMIC CHIP 0.01µF 10% 25V C14 1-163-275-11 CERAMIC CHIP 0.001µF 5% 50V C50 1-126-959-11 ELECT 0.47µF 20% 50V C51 1-126-935-11 ELECT 470µF 20% 16V C70 1-126-947-11 ELECT 47µF 20% 25V C71 1-162-970-11 CERAMIC CHIP 0.01µF 10% 25V C80 1-126-947-11 ELECT 47µF 20% 25V</p>			



REF. NO.	PART NO.	DESCRIPTION	VALUES			REF. NO.	PART NO.	DESCRIPTION	VALUES
R59	1-216-065-91	RES-CHIP	4.7K	5%	1/10W	4-073-477-01	CUSHION ASSY, LOWER (FOR 20FS100/21FS100/21FM100 ONLY)		
R72	1-218-700-11	METAL CHIP	2.2K	0.50%	1/16W	4-073-478-01	CUSHION ASSY, UPPER (FOR KV-20FS100/21FS100/21FM100 ONLY)		
R74	1-218-740-11	METAL CHIP	100K	0.50%	1/16W	4-085-774-01	CUSHION, UPPER (FOR KV-20FV300/21FV300 ONLY)		
R74	1-218-732-91	METAL CHIP	47K	0.5%	1/16W	4-085-775-01	CUSHION, LOWER (FOR 20FV300/21FV300 ONLY)		
R75	1-218-740-11	METAL CHIP	100K	0.50%	1/16W	4-087-501-01	CUSHION, UPPER (FOR 24FV300/25FV300 ONLY)		
R76	1-218-732-11	METAL CHIP	47K	0.50%	1/16W	4-087-502-01	CUSHION, LOWER (FOR 24FV300/25FV300 ONLY)		
R77	1-218-740-11	METAL CHIP	100K	0.50%	1/16W	4-086-340-21	MANUAL, INSTRUCTION (FOR 20FS100(U) ONLY)		
R78	1-208-814-91	METAL CHIP	22K	0.50%	1/10W	4-086-340-31	MANUAL, INSTRUCTION (FOR 20FS100(C) ONLY)		
R79	1-208-798-11	METAL CHIP	4.7K	0.50%	1/10W	4-086-341-41	MANUAL, INSTRUCTION (FOR 21FM100 ONLY)		
ACCESSORIES AND PACKING						4-086-342-41	MANUAL, INSTRUCTION (FOR 21FS100 ONLY)		
	1-501-730-41	ANTENNA, TELESCOPIC (FOR 21FS100/21FM100/21FV300/25FV300 ONLY)				4-086-343-21	MANUAL, INSTRUCTION (FOR 20FV300(U)/24FV300(U) ONLY)		
	4-041-255-01	BAG, PROTECTION (FOR 20FV300/21FV300/24FV300/25FV300 ONLY)				4-086-343-31	MANUAL, INSTRUCTION (FOR 20FV300(C)/24FV300(C) ONLY)		
	4-073-838-01	BAG, PROTECTION (FOR 20FS100 ONLY)				4-086-343-41	MANUAL, INSTRUCTION (FOR 21FV300/25FV300 ONLY)		
	4-073-838-21	BAG, PROTECTION (FOR 21FS100/21FM100 ONLY)				4-059-492-01	PERMALLOY (75) (ALL EXCEPT KV-24FV300/25FV300)		
	4-087-237-01	BRACKET, TERMINAL (FOR 20FS100/21FS100(N) ONLY)				REMOTE COMMANDER			
	4-087-237-11	BRACKET, TERMINAL (FOR 21FM100 ONLY)				1-476-680-11	REMOTE COMMANDER (RM-Y180) (FOR 20FV300/21FV300/24FV300/25FV300 ONLY)		
	4-085-776-01	CARTON, INDIVIDUAL (FOR 20FV300/21FV300 ONLY)				1-477-118-21	REMOTE COMMANDER (RM-Y172) (FOR 21FM100 ONLY)		
	4-087-323-02	CARTON, INDIVIDUAL (FOR 20FS100/21FS100/21FM100 ONLY)				1-477-119-21	REMOTE COMMANDER (RM-Y173) (FOR 20FS100/21FS100 ONLY)		
	4-087-500-01	CARTON, INDIVIDUAL (FOR 24FV300(U/C)/25FV300 ONLY)				4-978-977-11	BATTERY COVER (FOR RM-Y180) (FOR 20FV300/21FV300/24FV300/25FV300 ONLY)		
	1-417-182-11	CONVERTER (EAC-25) (FOR 21FM100/21FS100/21FV300/25FV300 ONLY)				3-709-322-31	BATTERY COVER (FOR RM-Y172, RM-Y173) (FOR 21FM100/20FS100/21FS100 ONLY)		

Sony Corporation
Sony Technology Center
Technical Services
Service Promotion Department

English
2002BJ74059-1
Printed in USA
© 2002.2

A BOARD SCHEMATIC DIAGRAM

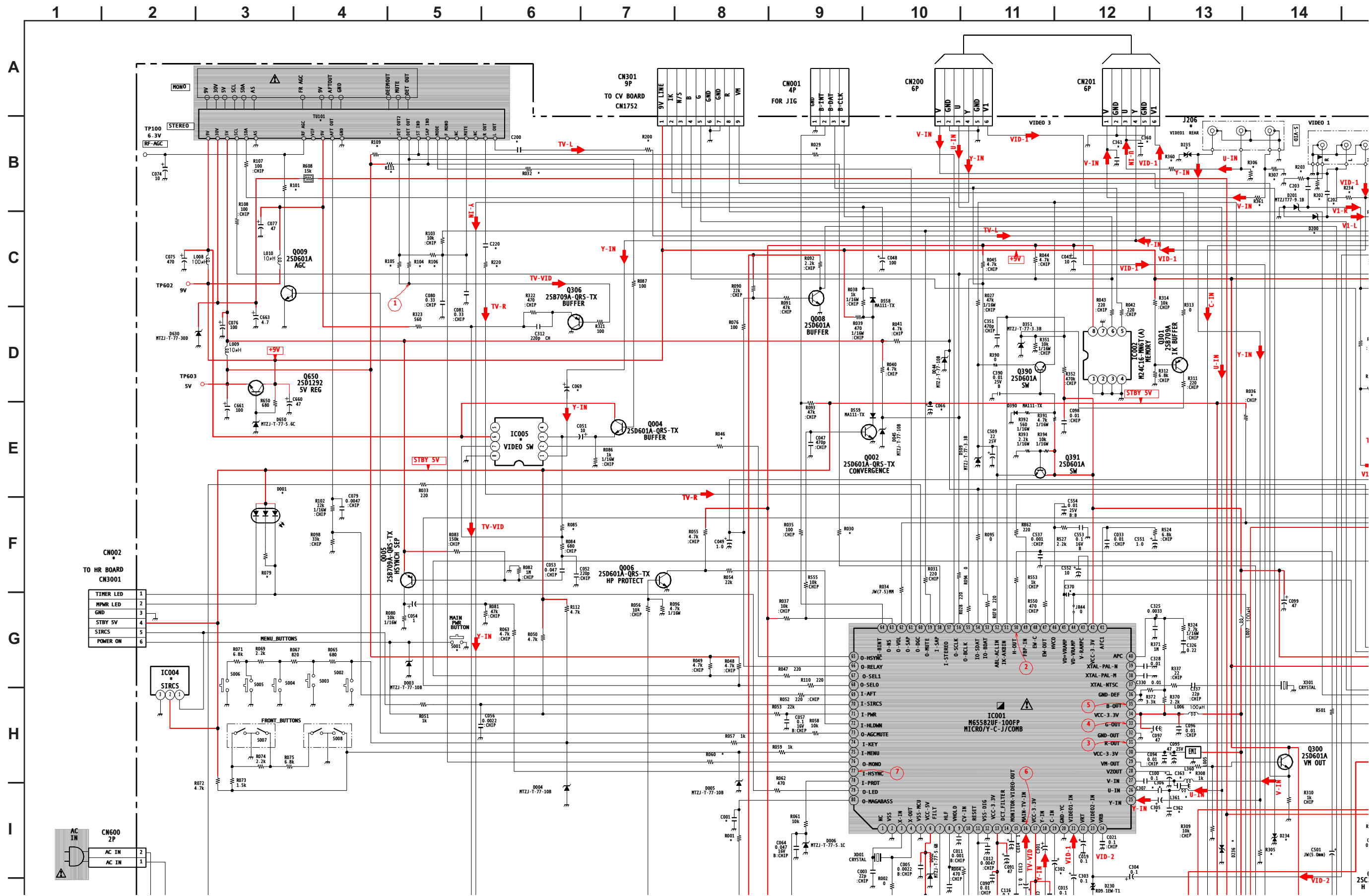

CN002
TO HR BOARD
CN3001

TIMER LED	1
MPM LED	2
GND	3
STBY 5V	4
SIRCS	5
POWER ON	6

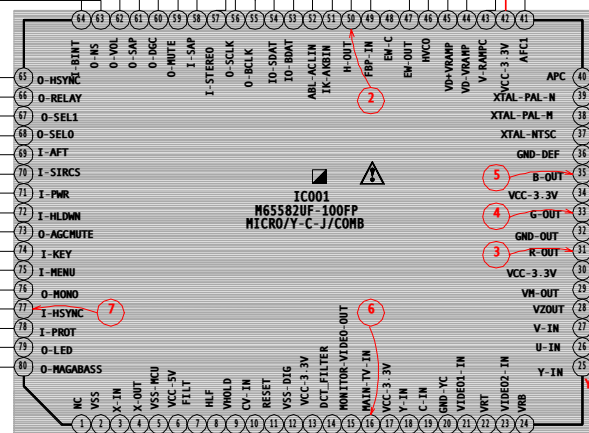
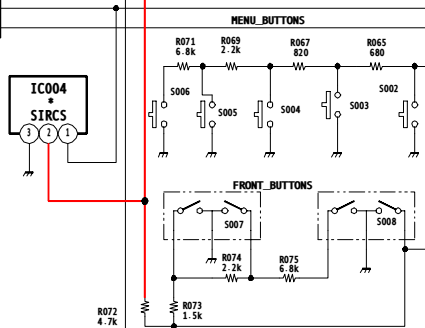

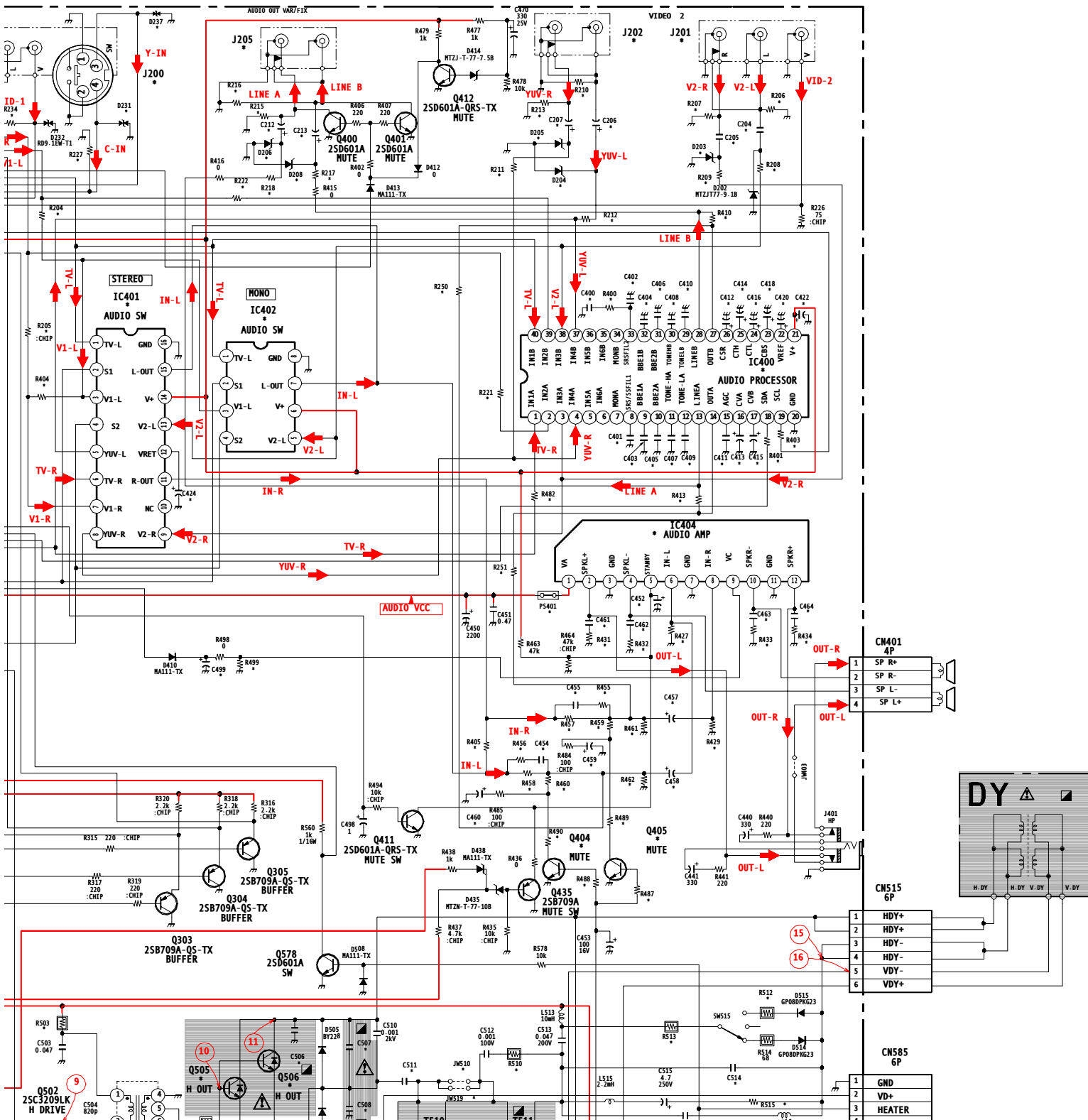

J
K
L
M
N
O

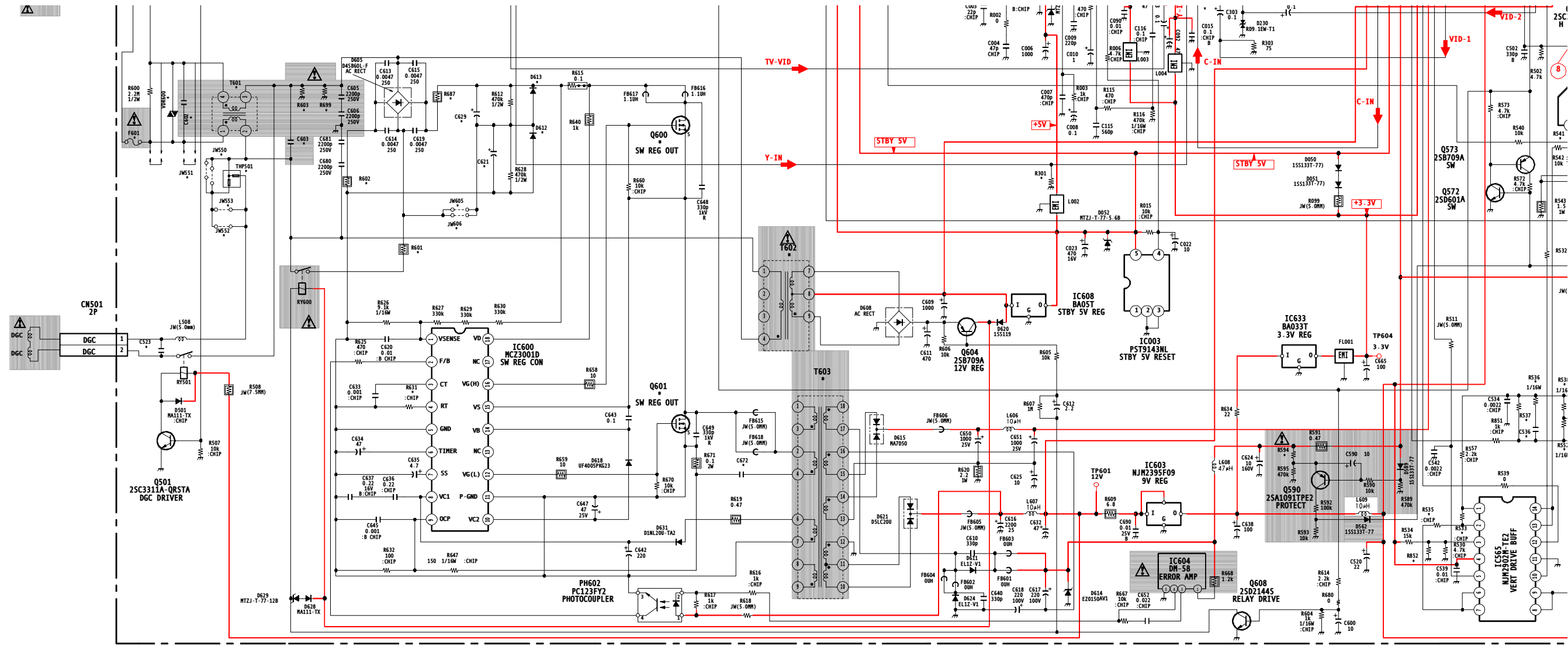

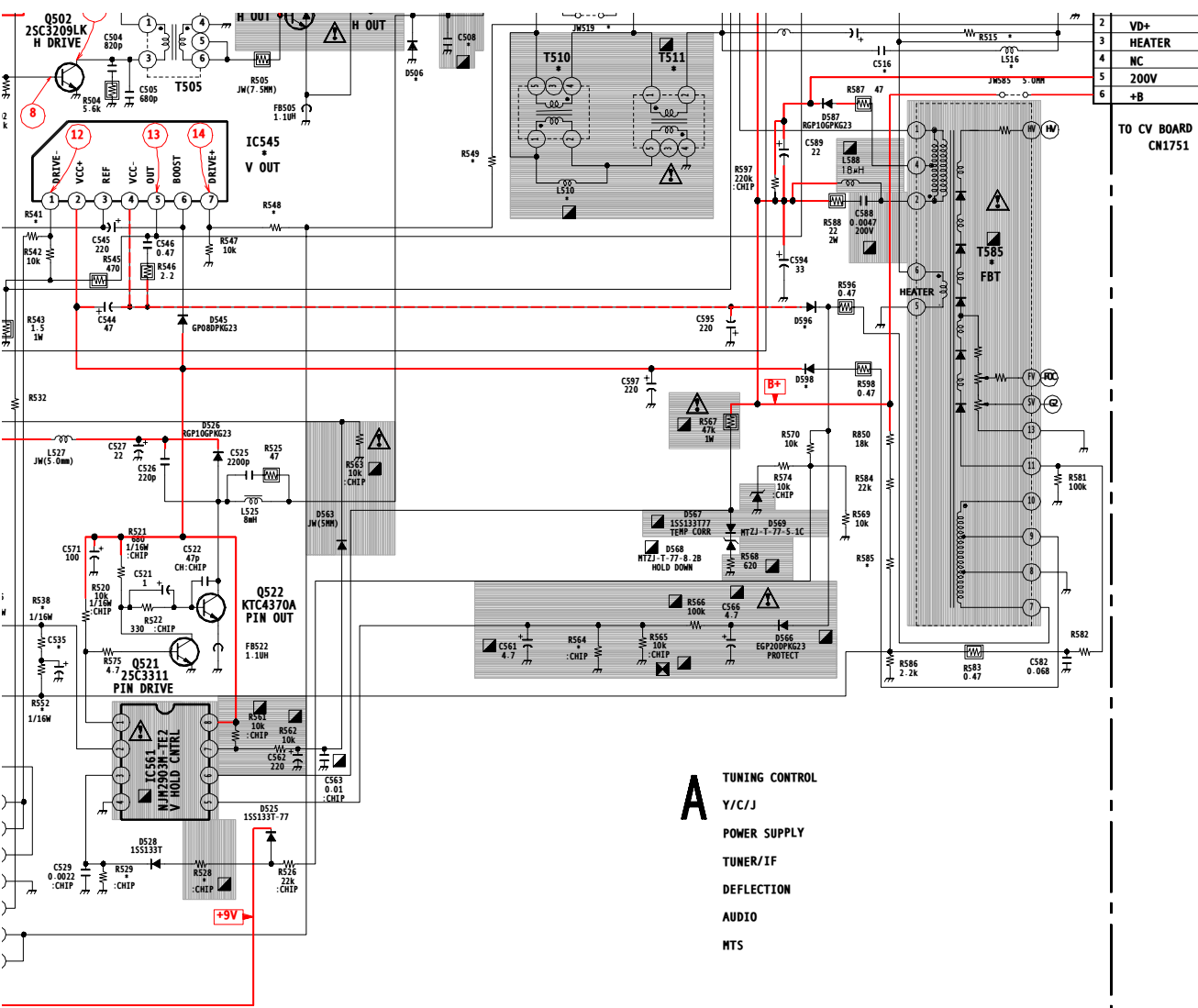

SERVICE MANUAL

BA-6 CHASSIS

Self Diagnosis
Supported model

<u>MODEL NAME</u>	<u>REMOTE COMMANDER</u>	<u>DESTINATION</u>	<u>CHASSIS NO.</u>
KV-20FS100	RM-Y173	US	SCC-S61A-A
KV-20FS100	RM-Y173	CND	SCC-S59A-A
KV-20FV300	RM-Y180	US	SCC-S61B-A
KV-20FV300	RM-Y180	CND	SCC-S59B-A
KV-21FM100	RM-Y172	LATIN NORTH	SCC-S60E-A
KV-21FM100	RM-Y172	LATIN SOUTH	SCC-S60F-A
KV-21FS100	RM-Y173	LATIN NORTH	SCC-S60A-A
KV-21FS100	RM-Y173	LATIN SOUTH	SCC-S60B-A
KV-21FV300	RM-Y180	LATIN SOUTH	SCC-S60D-A
KV-21FV300	RM-Y180	LATIN NORTH	SCC-S60C-A
KV-24FV300	RM-Y180	US	SCC-S61C-A
KV-24FV300	RM-Y180	CND	SCC-S59C-A
KV-25FV300	RM-Y180	LATIN NORTH	SCC-S60G-A
KV-25FV300	RM-Y180	LATIN SOUTH	SCC-S60H-A

SUPPLEMENT - 1

SUBJECT: NEW A BOARD SCHEM. AND PWB. NEW CV BOARD SCHEM.
NEW M3 BOARD SCHEM. R039, R565, R1781 P/N CORRECTED,

Correct the service manual as shown.
File this Supplement with the service manual.

✎ : Corrected Item

Section 5: Diagrams	A Board Schematic	Page 31
	A Board PWB	Page 32
	CV Board Schematic	Page 41
	M3 Board Schematic	Page 44
Section 7: Electrical Parts List		Pages 56, 58, 81

TRINITRON® COLOR TELEVISION

SONY®

A BOARD SCHEMATIC DIAGRAM

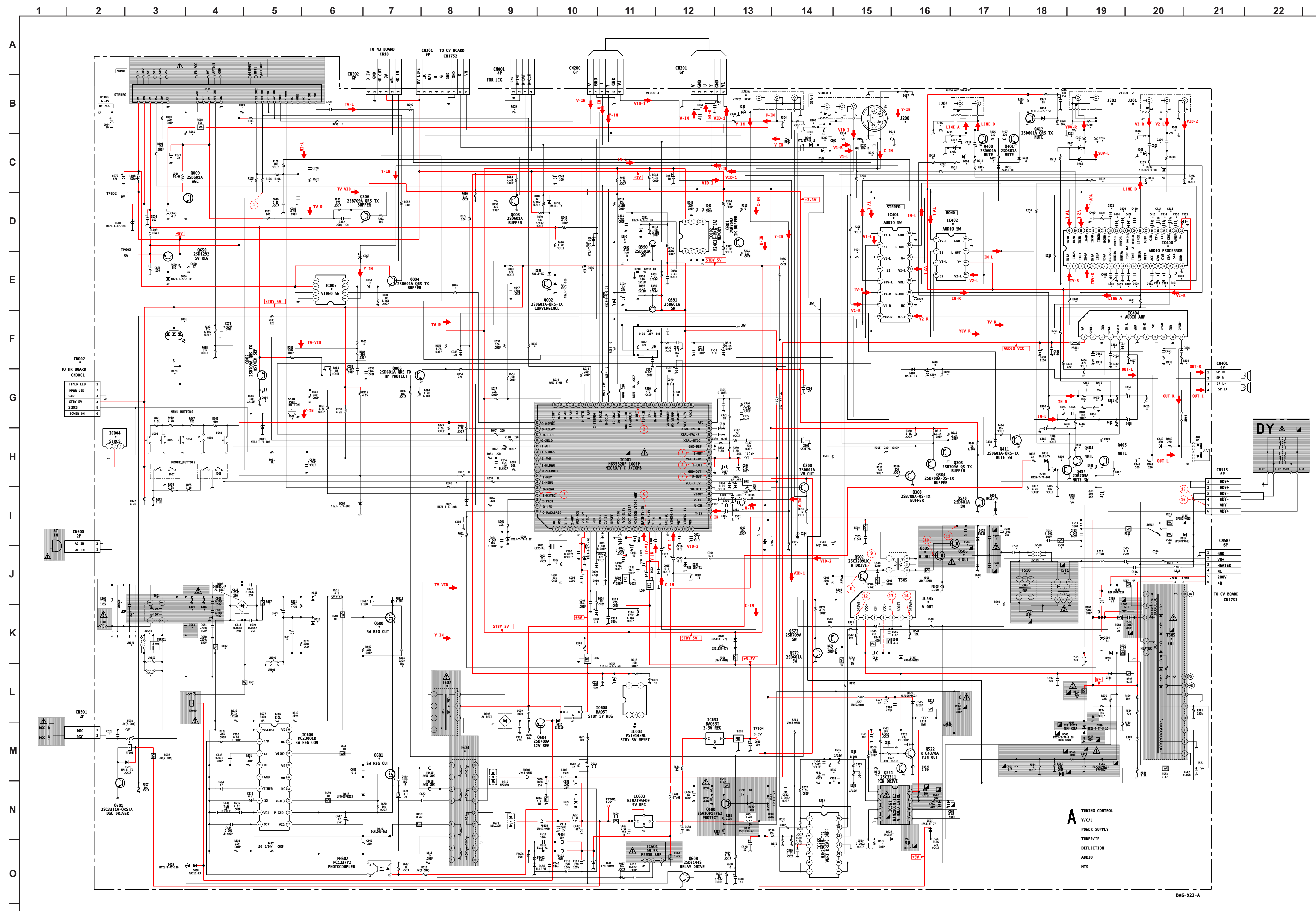

A TUNING CONTROL
 Y/C/I
 POWER SUPPLY
 TUNER/IF
 DEFLECTION
 AUDIO
 HTS



A

[POWER SUPPLY, DEFLECTION, TUNER/IF, AUDIO, MTS, TUNING CONTROL, Y-C JUNGLE]

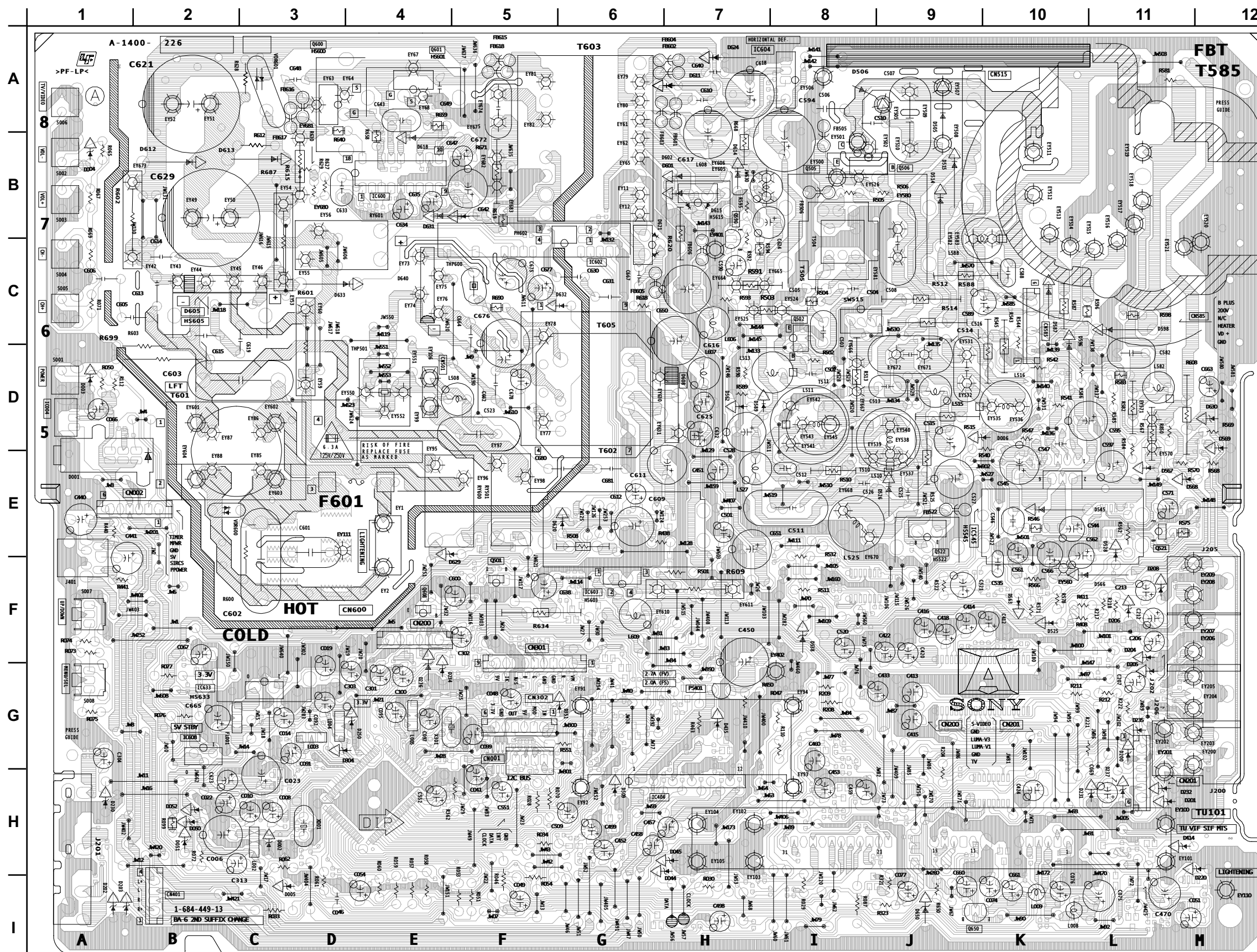

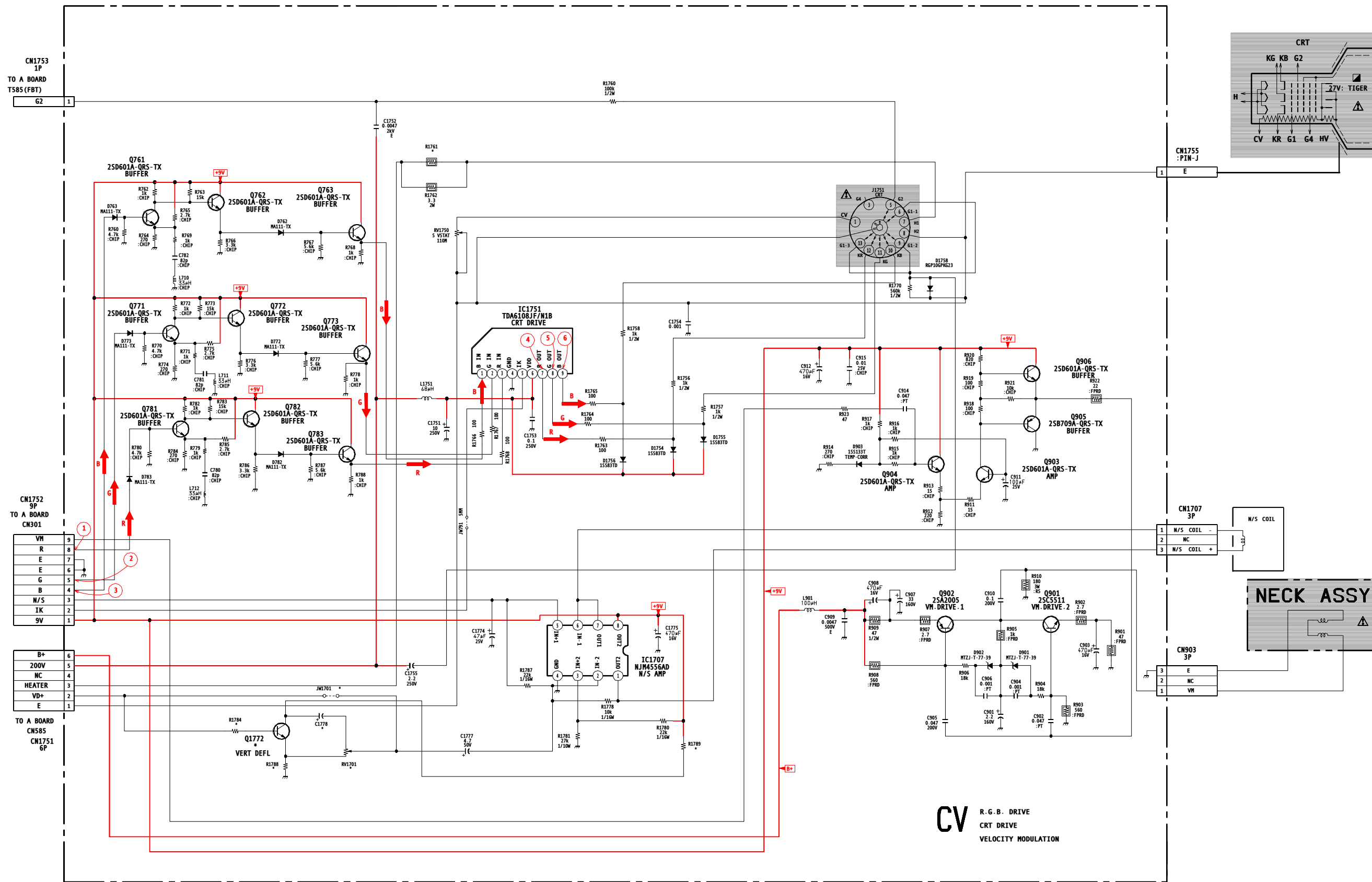

CV BOARD SCHEMATIC DIAGRAM

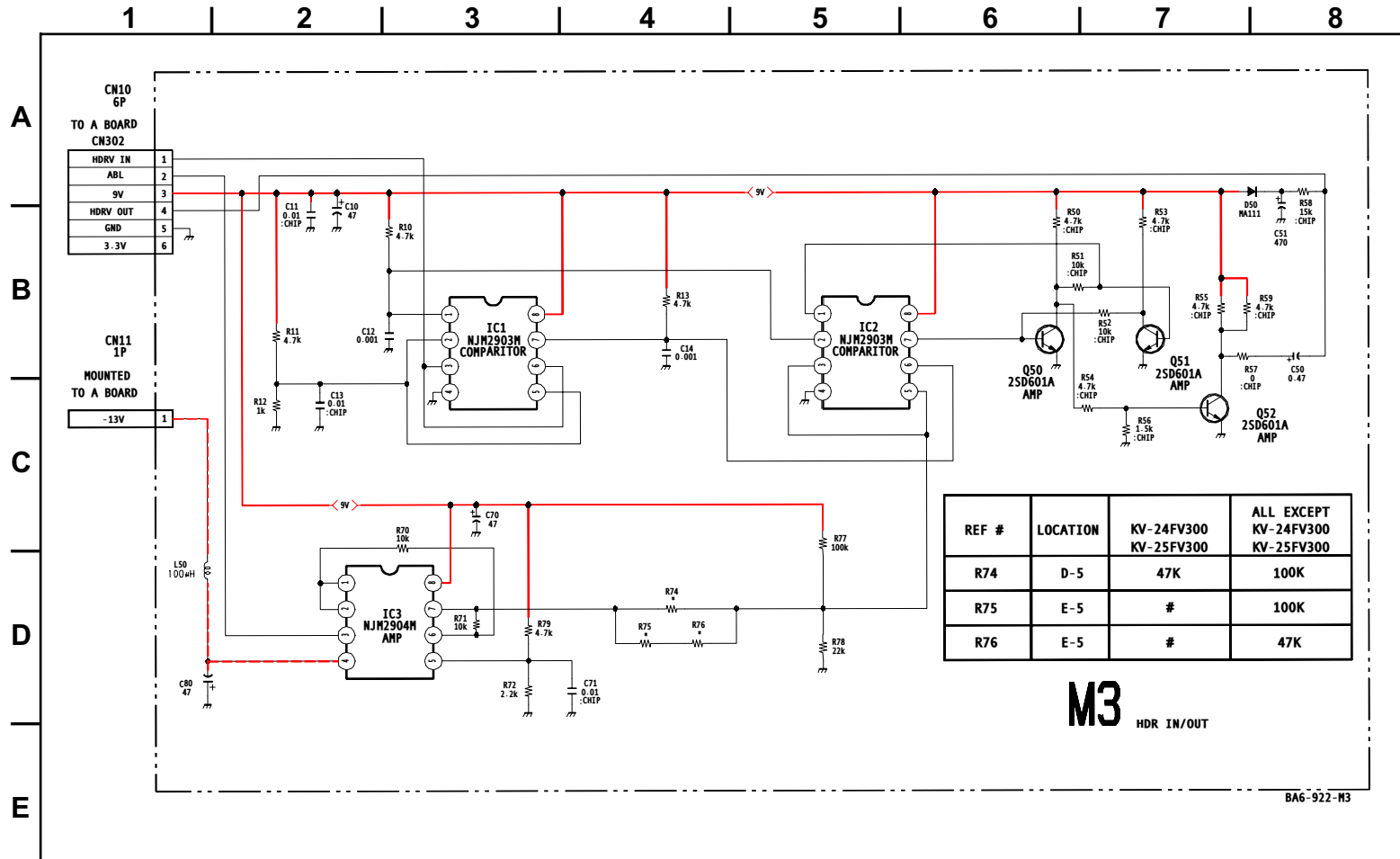

CV R.G.B. DRIVE
CRT DRIVE
VELOCITY MODULATION

M3 BOARD SCHEMATIC DIAGRAM



NOTE: The components identified by shading and  mark are critical FOR safety. Replace ONLY with part number specified.

A component identified by this  symbol indicates that it has been carefully factory-selected to satisfy regulations regarding X-ray radiation. Should replacement be required, replace ONLY with the value originally used.

P. 56

Incorrect

REF. NO.	PART NO.	DESCRIPTION	VALUES		
R039	1-216-817-11	RES-CHIP	470	5%	1/10W



Correct

REF. NO.	PART NO.	DESCRIPTION	VALUES		
R039	1-216-815-11	RES-CHIP	330	5%	1/10W





P. 58

Incorrect

REF. NO.	PART NO.	DESCRIPTION	VALUES		
  R565	1-216-833-11	RES-CHIP	10K	5%	1/10W

Correct

REF. NO.	PART NO.	DESCRIPTION	VALUES		
  R565	1-218-716-11	RES-CHIP	10K	0.5%	1/16W



P. 81

Incorrect

REF. NO.	PART NO.	DESCRIPTION	VALUES		
R1781	1-216-837-11	RES-CHIP	22K	5%	1/10W

Correct

REF. NO.	PART NO.	DESCRIPTION	VALUES		
R1781	1-216-838-11	RES-CHIP	27K	5%	1/10W



PRINTING THE SERVICE MANUAL

The PDF of this service manual is not designed to be printed from cover to cover. The pages vary in size, and must therefore be printed in sections based on page dimensions.

NON-SCHEMATIC PAGES

Data that does NOT INCLUDE schematic diagrams are formatted to 8.5 x 11 inches and can be printed on standard letter-size and/or A4-sized paper.

SCHEMATIC DIAGRAMS

The schematic diagram pages are provided in two ways, full size and tiled. The full-sized schematic diagrams are formatted on paper sizes between 8.5" x 11" and 18" x 30" depending upon each individual diagram size. Those diagrams that are LARGER than 11" x 17" in full-size mode have been tiled for your convenience and can be printed on standard 11" x 17" (tabloid-size) paper, and reassembled.

TO PRINT FULL SIZE SCHEMATIC DIAGRAMS

If you have access to a large paper plotter or printer capable of outputting the full-sized diagrams, output as follows:

- 1) Note the page size(s) of the schematics you want to output as indicated in the middle window at the bottom of the viewing screen.
- 2) Go to the File menu and select Print Set-up. Choose the printer name and driver for your large format printer. Confirm that the printer settings are set to output the indicated page size or larger.
- 3) Close the Print Set Up screen and return to the File menu. Select "Print..." Input the page number of the schematic(s) you want to print in the print range window. Choose OK.

TO PRINT TILED VERSION OF SCHEMATICS



Schematic pages that are larger than 11" x 17" full-size are provided in a 11" x 17" printable tiled format near the end of the document. These can be printed to tabloid-sized paper and assembled to full-size for easy viewing.

If you have access to a printer capable of outputting the tabloid size (11" x 17") paper, then output the tiled version of the diagram as follows:

- 1) Note the page number(s) of the schematics you want to output as indicated in the middle window at the bottom of the viewing screen.
- 2) Go to the File menu and select Print Set-up. Choose the printer name and driver for your printer. Confirm that the plotter settings are set to output 11" x 17", or tabloid size paper in landscape () mode.
- 3) Close the Print Set Up screen and return to the File menu. Select "Print..." Input the page number of the schematic(s) you want to print in the print range window. Choose OK.

TO PRINT SPECIFIC SECTIONS OF A SCHEMATIC

To print just a particular section of a PDF, rather than a full page, access the Graphics Select tool in the Acrobat Reader tool bar.

- 1) To view the Graphics Select Tool, press and HOLD the mouse button over the Text Select Tool which looks like: . This tool will expand to reveal additional tools. Choose the Graphics Select tool by placing the cursor over the button on of the far right that looks like: .
- 2) After selecting the Graphics Select Tool, place your cursor in the document window and the cursor will change to a plus (+) symbol. Click and drag the cursor over the area you want to print. When you release the mouse button, a marquee (or dotted lined box) will be displayed outlining the area you selected.
- 3) With the marquee in place, go to the file menu and select the "Print..." option. When the print window appears, choose the option under the section called "Print Range" which says "Selected Graphic".

Select OK and the output will print only the area that you outlined with the marquee. 

(continued >)

ON-SCREEN SEARCH OPTION

All of the text within the service manual PDF is content searchable. This means that you can enter any text, word, phrase or reference number that appears in the manual, and the PDF software will search, find and move the cursor to the location where you requested text first appears. This feature can be particularly useful in locating components on a specific schematic or printed wire circuit board (PWB) diagrams.

Follow these steps to effectively locate a component on a schematic diagram:

- 1) Locate the schematic you want to search by clicking on the corresponding bookmark on the left side of the screen. The view on the right of the screen will then jump to the desired schematic page.
- 2) Magnify the diagram to at least 400% before conducting a component search. This will enable you to easily view the reference number when it is highlighted on screen. To do this, click on the magnifying glass button on the tool bar at the top of the screen. Move the cursor over the diagram and RIGHT click you mouse. Select the 400% magnification option on the pop-up menu. Click on the button with the icon of the open hand to deactivate the magnification tool
- 3) Search the diagram (or the entire manual) by clicking on the binocular button tool at the top of the screen. The "Find" window will appear and allow you to type in your desired text. Type in a reference designator, such as R502, and click on the "Find" button. If the component is not on the diagram, but is listed anywhere else in the manual, the cursor will jump to the first location the text is found in the file. To find another instance of that same text, click on the binocular button again and select "Find Again."